



## // STANDARD

// FERRULES.....	49	// NPTF INSERTS .....	83
// HOSE MENDER.....	51	// NPSM INSERTS .....	85
// BSP INSERTS .....	52	// ORFS INSERTS .....	86
// DIN METRIC INSERTS .....	59	// FRENCH INSERTS.....	90
// PRESSURE WASHER.....	73	// JIS INSERTS.....	91
// SAE INSERTS .....	74	// KOMATSU INSERTS .....	93
// JIC 37° INSERTS.....	77	// SAE FLANGES .....	95

Dimensions shown may be changed without prior notice

## // FERRULES

### // H1100104 Skive Ferrule

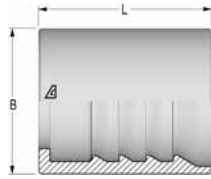

Item Code	ID			OD	L
	Dash	mm	in		
1201545	20	31,0	1 1/4"	50,0	43,8
1201546	24	38,0	1 1/2"	57,0	49,2
1201547	32	51,0	2"	71,0	63,7

### // H1100404 Skive Ferrule

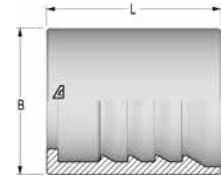

Item Code	ID			OD	L
	Dash	mm	in		
1202719	04	6,0	1/4"	22,0	26,3
1203253	06	10,0	3/8"	25,0	28,5
1203266	08	13,0	1/2"	29,0	34,7
1219132	10	16,0	5/8"	33,0	37,5
1203368	12	19,0	3/4"	37,0	41,5

### // H1200204 No-skive Ferrule

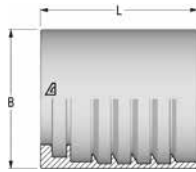

Item Code	ID			OD	L
	Dash	mm	in		
1216588	06	10,0	3/8"	30,0	28,0
1216589	08	13,0	1/2"	34,0	33,9
1216590	10	16,0	5/8"	38,0	36,6
1203322	12	19,0	3/4"	42,0	39,5
1203323	16	25,0	1"	50,0	47,5
1216591	20	31,0	1 1/4"	61,0	50,2

### // H1200203 No-skive Ferrule

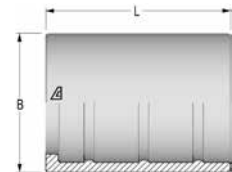

Item Code	ID			OD	L
	Dash	mm	in		
1203311	03	5,0	3/16"	20,0	24,3
1202720	04	6,0	1/4"	22,0	26,3
1202721	05	8,0	5/16"	25,0	26,3
1202722	06	10,0	3/8"	25,0	27,2
1202723	08	13,0	1/2"	29,0	32,8
1202724	10	16,0	5/8"	34,0	35,6
1202725	12	19,0	3/4"	38,0	38,6
1202726	16	25,0	1"	50,0	45,4
1202727	20	31,0	1 1/4"	51,0	49,0
1202728	24	38,0	1 1/2"	60,0	56,0
1202729	32	51,0	2"	76,1	69,0
1203062	40	63,0	2 1/2"	88,9	85,0

### // H1100SK1 Skive Ferrule

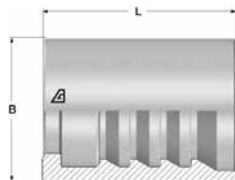

Item Code	ID			OD	L
	Dash	mm	in		
1233077	04	6,0	1/4"	19,0	25,5
1233078	05	8,0	5/16"	21,0	25,5
1233079	06	10,0	3/8"	23,0	27,5
1233080	08	13,0	1/2"	27,0	33,5
1233081	10	16,0	5/8"	30,00	36,5
1233082	12	19,0	3/4"	33,00	40,0
1233083	16	25,0	1"	41,0	46,5

### // H1200TP0 No-skive Ferrule

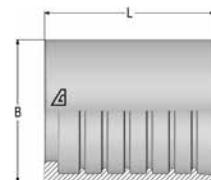

Item Code	ID			OD	L
	Dash	mm	in		
1232354	03	5,0	3/16"	15,0	22,0
1232358	04	6,0	1/4"	17,0	26,5
1232359	05	8,0	5/16"	19,0	26,5
1232360	06	10,0	3/8"	22,0	26,5
1232361	08	13,0	1/2"	26,0	30,5

**// H2200TF0**  
No-skive Ferrule

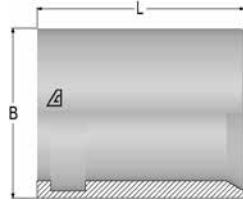

Item Code	ID		OD		L
	Dash	mm	in	mm	mm
1232132	03	5,0	3/16"	14,0	20,0
1232133	04	6,0	1/4"	15,0	25,0
1232134	05	8,0	5/16"	17,2	25,0
1232135	06	10,0	3/8"	22,0	25,0
1232136	08	13,0	1/2"	25,0	30,0
1232137	10	16,0	5/8"	30,0	33,0
1232138	12	19,0	3/4"	35,0	37,0
1232139	16	25,0	1"	42,0	45,0
1232140	20	31,0	1 1/4"	50,0	48,0
1232141	24	38,0	1 1/2"	57,0	58,0
1232142	32	51,0	2"	73,0	67,0

**// H1200TX2**  
No-skive Ferrule

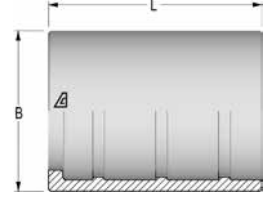

Item Code	ID		OD		L
	Dash	mm	in	mm	mm
1236581	03	5,0	3/16"	21,0	21,5
1236582	04	6,0	1/4"	23,0	24,7
1236583	05	8,0	5/16"	25,0	24,7
1236584	06	10,0	3/8"	27,0	29,7
1236585	08	13,0	1/2"	30,0	30,5
1236586	10	16,0	5/8"	34,0	35,5
1236587	12	19,0	3/4"	38,0	36,0
1236588	16	25,0	1"	48,0	42,5
1236589	20	31,0	1 1/4"	53,0	56,5
1236590	24	38,0	1 1/2"	60,0	61,5
1236591	32	51,0	2"	76,0	73,5
1236592	40	63,0	2 1/2"	89,0	85,0

**// H1200AD1**  
No-skive Ferrule

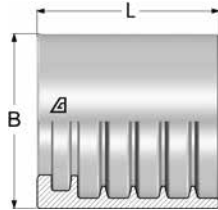

Item Code	ID		OD		L
	Dash	mm	in	mm	mm
1227977	03	5,0	3/16"	19,0	24,0
1227978	04	6,0	1/4"	22,0	24,7
1227979	05	8,0	5/16"	23,0	24,7
1227980	06	10,0	3/8"	26,00	29,7
1227981	08	13,0	1/2"	29,0	30,5
1227983	10	16,0	5/8"	32,00	30,5
1227985	12	19,0	3/4"	36,0	36,0
1227986	16	25,0	1"	44,0	36,7
1227987	20	31,0	1 1/4"	53,0	48,6
1227988	24	38,0	1 1/2"	61,0	48,6
1227989	32	51,0	2"	75,0	48,6

**// H1200AD2**  
No-skive Ferrule

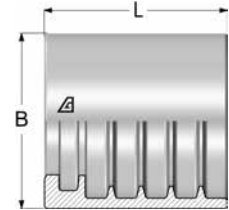

Item Code	ID		OD		L
	Dash	mm	in	mm	mm
1227990	03	5,0	3/16"	21,0	21,5
1227991	04	6,0	1/4"	23,0	24,7
1227992	05	8,0	5/16"	25,0	24,7
1227993	06	10,0	3/8"	27,0	29,7
1227994	08	13,0	1/2"	30,0	30,5
1227995	10	16,0	5/8"	33,0	30,5
1227996	12	19,0	3/4"	37,0	36,0
1227997	16	25,0	1"	45,0	36,7
1227998	20	31,0	1 1/4"	56,0	48,6
1227999	24	38,0	1 1/2"	64,0	48,5
1228000	32	51,0	2"	78,0	48,6

Dimensions shown may be changed without prior notice

## // HOSE MENDER

### // H12C5610 Hose Mender

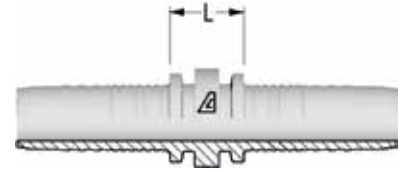

Item Code	Tale/Head	Dash	ID		F1
	Dash		mm	in	Dash Size
1202949	-0404	04	6,0	1/4"	04
1202870	-0505	05	8,0	5/16"	05
1202868	-0606	06	10,0	3/8"	06
1202867	-0808	08	13,0	1/2"	08
1203160	-1010	10	16,0	5/8"	10
1203161	-1212	12	19,0	3/4"	12
1220608	-1616	16	25,0	1"	16
1220607	-2020	20	32,0	1 1/4"	20
1220605	-2424	24	38,0	1 1/2"	24
1220606	-3232	32	51,0	2"	32

# // BSP INSERTS

## // H1210510

**BSPP Male 60° Flare  
AGR**

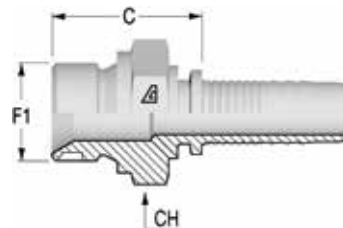

Item Code	Tale/Head	Nut Type	ID			F1	F1	C	CH
	Dash		Dash	mm	in	Dash Size		mm	mm
1201291	-0302	NA	03	5,0	3/16"	02	1/8-28	20,3	14,0
1201722	-0402	NA	04	6,0	1/4"	02	1/8-28	20,8	14,0
1200507	-0404	NA	04	6,0	1/4"	04	1/4-19	26,3	19,0
1200508	-0406	NA	04	6,0	1/4"	06	3/8-19	27,8	22,0
1201098	-0408	NA	04	6,0	1/4"	08	1/2-14	31,3	27,0
1200540	-0504	NA	05	8,0	5/16"	04	1/4-19	26,3	19,0
1200541	-0506	NA	05	8,0	5/16"	06	3/8-19	27,8	22,0
1201101	-0508	NA	05	8,0	5/16"	08	1/2-14	31,3	27,0
1200340	-0604	NA	06	10,0	3/8"	04	1/4-19	26,3	19,0
1200341	-0606	NA	06	10,0	3/8"	06	3/8-19	27,8	22,0
1200339	-0608	NA	06	10,0	3/8"	08	1/2-14	31,3	27,0
1200386	-0806	NA	08	13,0	1/2"	06	3/8-19	28,6	22,0
1200384	-0808	NA	08	13,0	1/2"	08	1/2-14	32,1	27,0
1201096	-0810	NA	08	13,0	1/2"	10	5/8-14	34,1	30,0
1200385	-0812	NA	08	13,0	1/2"	12	3/4-14	36,1	32,0
1201085	-1008	NA	10	16,0	5/8"	08	1/2-14	32,1	27,0
1200419	-1010	NA	10	16,0	5/8"	10	5/8-14	34,1	30,0
1200418	-1012	NA	10	16,0	5/8"	12	3/4-14	36,1	32,0
1200446	-1212	NA	12	19,0	3/4"	12	3/4-14	36,6	32,0
1201095	-1216	NA	12	19,0	3/4"	16	1-11	41,6	41,0
1201355	-1616	NA	16	25,0	1"	16	1-11	42,4	41,0
1201356	-1620	NA	16	25,0	1"	20	1 1/4-11	46,4	50,0
1201357	-2020	NA	20	32,0	1 1/4"	20	1 1/4-11	48,0	50,0
1201358	-2424	NA	24	38,0	1 1/2"	24	1 1/2-11	51,0	55,0
1221561	-2432	NA	24	38,0	1 1/2"	32	2-11	56,5	70,0
1201359	-3232	NA	32	51,0	2"	32	2-11	56,5	70,0

## // H1210610

**BSPP Male Flat Seat  
AGR FD**

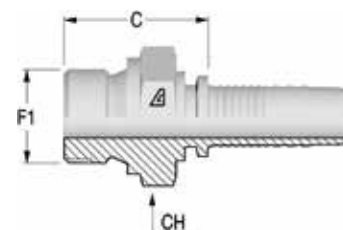

Item Code	Tale/Head	Nut Type	ID			F1	F1	C	CH
	Dash		Dash	mm	in	Dash Size		mm	mm
1214181	-0404	NA	04	6,0	1/4"	04	1/4-19	26,3	19,0
1223423	-0606	NA	06	10,0	3/8"	06	3/8-19	27,8	22,0
1216596	-0608	NA	06	10,0	3/8"	08	1/2-14	31,3	27,0
1225012	-0808	NA	08	13,0	1/2"	08	1/2-14	32,1	27,0
1216597	-1010	NA	10	16,0	5/8"	10	5/8-14	34,1	30,0

Dimensions shown may be changed without prior notice

**// H1210710**

**BSPT Male  
AGR K**

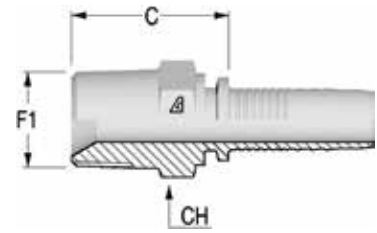

Item Code	Tale/Head Dash	Nut Type	ID		F1		F1	C	CH
			Dash	mm	in	Dash Size			
1200456	-0302	NA	03	5,0	3/16"	02	1/8-28	20,8	12,0
1200491	-0402	NA	04	6,0	1/4"	02	1/8-28	21,3	12,0
1200490	-0404	NA	04	6,0	1/4"	04	1/4-19	26,8	17,0
1200492	-0406	NA	04	6,0	1/4"	06	3/8-19	27,8	19,0
1200532	-0504	NA	05	8,0	5/16"	04	1/4-19	26,8	17,0
1200533	-0506	NA	05	8,0	5/16"	06	3/8-19	27,8	19,0
1200328	-0604	NA	06	10,0	3/8"	04	1/4-19	26,8	17,0
1200329	-0606	NA	06	10,0	3/8"	06	3/8-19	27,8	19,0
1200327	-0608	NA	06	10,0	3/8"	08	1/2-14	32,3	22,0
1200373	-0806	NA	08	13,0	1/2"	06	3/8-19	28,6	19,0
1200371	-0808	NA	08	13,0	1/2"	08	1/2-14	33,1	22,0
1200410	-1012	NA	10	16,0	5/8"	12	3/4-14	34,1	27,0
1200440	-1212	NA	12	19,0	3/4"	12	3/4-14	34,6	27,0
1200439	-1216	NA	12	19,0	3/4"	16	1-11	43,6	36,0
1201365	-1612	NA	16	25,0	1"	12	3/4-14	37,4	32,0
1201361	-1616	NA	16	25,0	1"	16	1-11	44,4	36,0
1201363	-2020	NA	20	32,0	1 1/4"	20	1 1/4-11	49,0	46,0
1201364	-2424	NA	24	38,0	1 1/2"	24	1 1/2-11	50,5	50,0
1201360	-3232	NA	32	51,0	2"	32	2-11	54,2	65,0

**// H1220813**

**BSPF Female 60° Cone with O-Ring  
DKOR**

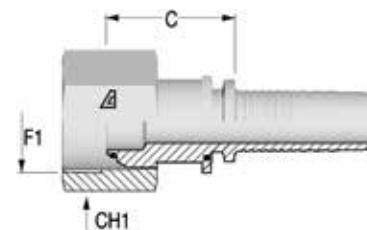

Item Code	Tale/Head	Nut Type	ID			F1		C	CH1
	Dash		Dash	mm	in	Dash Size	F1		
1200606	-0302	CR	03	5,0	3/16"	02	1/8-28	14,3	14,0
1202325	-0304	SN	03	5,0	3/16"	04	1/4-19	20,3	19,0
1201066	-0402	CR	04	6,0	1/4"	02	1/8-28	14,7	14,0
1202326	-0404	SN	04	6,0	1/4"	04	1/4-19	20,8	19,0
1202327	-0406	SN	04	6,0	1/4"	06	3/8-19	23,3	22,0
1202328	-0504	CR	05	8,0	5/16"	04	1/4-19	17,3	19,0
1202329	-0506	SN	05	8,0	5/16"	06	3/8-19	23,3	22,0
1202330	-0604	CR	06	10,0	3/8"	04	1/4-19	17,3	19,0
1202331	-0606	SN	06	10,0	3/8"	06	3/8-19	23,3	22,0
1202332	-0608	SN	06	10,0	3/8"	08	1/2-14	24,3	27,0
1202571	-0806	CR	08	13,0	1/2"	06	3/8-19	18,6	22,0
1202333	-0808	SN	08	13,0	1/2"	08	1/2-14	25,1	27,0
1202334	-0810	SN	08	13,0	1/2"	10	5/8-14	28,4	27,0
1202335	-0812	SN	08	13,0	1/2"	12	3/4-14	29,0	32,0
1202457	-1010	CR	10	16,0	5/8"	10	5/8-14	17,1	27,0
1202336	-1012	SN	10	16,0	5/8"	12	3/4-14	29,0	32,0
1202462	-1212	CR	12	19,0	3/4"	12	3/4-14	23,9	32,0
1202337	-1216	SN	12	19,0	3/4"	16	1-11	34,0	38,0
1202455	-1616	CR	16	25,0	1"	16	1-11	23,9	38,0
1202338	-1620	SN	16	25,0	1"	20	1 1/4-11	39,4	50,0
1202458	-2020	TN	20	32,0	1 1/4"	20	1 1/4-11	32,0	50,0
1202339	-2024	SN	20	32,0	1 1/4"	24	1 1/2-11	41,9	55,0
1202463	-2424	TN	24	38,0	1 1/2"	24	1 1/2-11	33,8	55,0
1202340	-2432	SN	24	38,0	1 1/2"	32	2-11	47,0	70,0
1202014	-3232	TN	32	51,0	2"	32	2-11	34,0	70,0

Dimensions shown may be changed without prior notice

**// H1220843**

**45° BSPP Female 60° Cone with O-Ring  
DKOR 45  
Solid one piece**

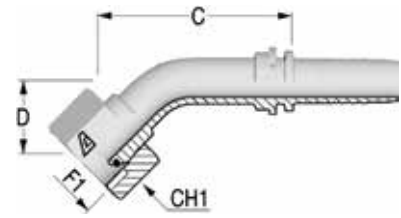

Item Code	Tale/Head Dash	Nut Type	ID		F1		F1	C	D Drop	CH1
			Dash	mm	in	Dash Size				
1202341	-0404	SN	04	6,0	1/4"	04	1/4-19	45,5	15,0	19,0
1202342	-0406	SN	04	6,0	1/4"	06	3/8-19	41,5	17,5	22,0
1214200	-0504	CR	05	8,0	5/16"	04	1/4-19	19,0	17,5	19,0
1202343	-0506	SN	05	8,0	5/16"	06	3/8-19	45,1	18,5	22,0
1202344	-0606	SN	06	10,0	3/8"	06	3/8-19	49,9	20,5	22,0
1202345	-0608	SN	06	10,0	3/8"	08	1/2-14	45,7	21,0	27,0
1202346	-0808	SN	08	13,0	1/2"	08	1/2-14	55,0	21,0	27,0
1202347	-0810	SN	08	13,0	1/2"	10	5/8-14	57,2	23,0	27,0
1202348	-0812	SN	08	13,0	1/2"	12	3/4-14	56,7	23,0	32,0
1202464	-1010	CR	10	16,0	5/8"	10	5/8-14	64,0	21,5	27,0
1202349	-1012	SN	10	16,0	5/8"	12	3/4-14	66,5	22,5	32,0
1202465	-1212	CR	12	19,0	3/4"	12	3/4-14	70,0	28,0	32,0
1202350	-1216	SN	12	19,0	3/4"	16	1-11	74,6	31,5	38,0
1202466	-1616	CR	16	25,0	1"	16	1-11	84,0	34,0	38,0
1216663	-1620	SN	16	25,0	1"	20	1 1/4-11	97,0	47,5	50,0
1202467	-2020	TN	20	32,0	1 1/4"	20	1 1/4-11	100,8	40,0	50,0
1202351	-2024	SN	20	32,0	1 1/4"	24	1 1/2-11	114,9	38,0	55,0
1202468	-2424	TN	24	38,0	1 1/2"	24	1 1/2-11	115,7	46,0	55,0
1202352	-2432	SN	24	38,0	1 1/2"	32	2-11	122,4	45,0	70,0
1202469	-3232	TN	32	51,0	2"	32	2-11	151,5	60,0	70,0



**// H1220893**

**90° BSP Female 60° Cone with O-Ring**

**DKOR 90**

**Solid one piece**

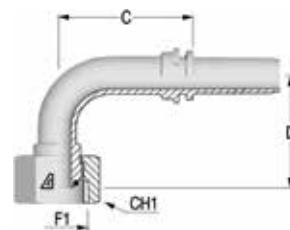

Item Code	Tale/Head	Nut Type	ID			F1		C	D Drop	CH1
	Dash		Dash	mm	in	Dash Size	F1			
1200607	-0302	CR	03	5,0	3/16"	02	1/8-28	24,0	30,0	14,0
1202474	-0304	SN	03	5,0	3/16"	04	1/4-19	32,6	30,0	19,0
1201707	-0402	CR	04	6,0	1/4"	02	1/8-28	30,5	32,0	14,0
1202367	-0404	SN	04	6,0	1/4"	04	1/4-19	29,3	29,0	19,0
1202353	-0406	SN	04	6,0	1/4"	06	3/8-19	29,8	31,0	22,0
1202354	-0506	SN	05	8,0	5/16"	06	3/8-19	33,2	36,0	22,0
1202355	-0606	SN	06	10,0	3/8"	06	3/8-19	34,8	42,0	22,0
1202356	-0608	SN	06	10,0	3/8"	08	1/2-14	34,3	35,5	27,0
1202881	-0806	CR	08	13,0	1/2"	06	3/8-19	35,3	43,0	22,0
1202357	-0808	SN	08	13,0	1/2"	08	1/2-14	35,8	41,0	27,0
1202358	-0810	SN	08	13,0	1/2"	10	5/8-14	41,6	43,5	27,0
1202359	-0812	SN	08	13,0	1/2"	12	3/4-14	41,8	43,0	32,0
1202470	-1010	CR	10	16,0	5/8"	10	5/8-14	47,9	47,0	27,0
1202360	-1012	SN	10	16,0	5/8"	12	3/4-14	51,9	49,0	32,0
1202471	-1212	CR	12	19,0	3/4"	12	3/4-14	49,1	53,0	32,0
1202361	-1216	SN	12	19,0	3/4"	16	1-11	54,1	60,5	38,0
1202475	-1616	CR	16	25,0	1"	16	1-11	75,1	69,0	38,0
1202362	-1620	SN	16	25,0	1"	20	1 1/4-11	75,1	88,5	50,0
1202472	-2020	TN	20	32,0	1 1/4"	20	1 1/4-11	82,3	83,0	50,0
1202363	-2024	SN	20	32,0	1 1/4"	24	1 1/2-11	101,0	83,0	55,0
1202456	-2424	TN	24	38,0	1 1/2"	24	1 1/2-11	95,7	96,0	55,0
1202364	-2432	SN	24	38,0	1 1/2"	32	2-11	107,8	104,0	70,0
1202473	-3232	TN	32	51,0	2"	32	2-11	128,5	136,0	70,0

Dimensions shown may be changed without prior notice

**// H1220581**

**90° Compact BSPP Female 60° Cone  
DKR 90**

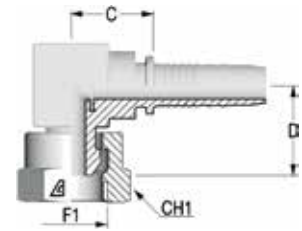

Item Code	Tale/Head Dash	Nut Type	ID			F1		F1	C	D Drop	CH1
			Dash	mm	in	Dash Size	F1				
1202422	-0404	CR	04	6,0	1/4"	04	1/4-19	16,8	19,5	19,0	
1202274	-0506	CR	05	8,0	5/16"	06	3/8-19	19,5	21,5	22,0	
1202025	-0606	CR	06	10,0	3/8"	06	3/8-19	18,8	22,0	22,0	
1202026	-0608	CR	06	10,0	3/8"	08	1/2-14	21,5	22,5	27,0	
1202027	-0808	CR	08	13,0	1/2"	08	1/2-14	22,6	24,5	27,0	
1203213	-1212	CR	12	19,0	3/4"	12	3/4-14	26,7	31,0	32,0	
1203330	-1616	CR	16	25,0	1"	16	1-11	34,5	27,5	38,0	

**// H1220613**

**BSP Female Flat Seat  
DKR FD**

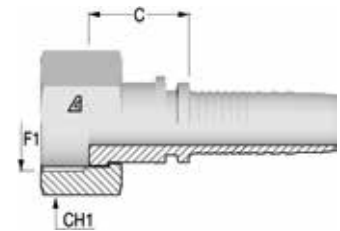

Item Code	Tale/Head Dash	Nut Type	ID			F1		F1	C	CH1
			Dash	mm	in	Dash Size	F1			
1202226	-0404	SN	04	6,0	1/4"	04	1/4-19	20,3	19,0	
1202227	-0606	SN	06	10,0	3/8"	06	3/8-19	20,3	22,0	
1202140	-0608	SN	06	10,0	3/8"	08	1/2-14	20,8	27,0	
1202228	-0808	SN	08	13,0	1/2"	08	1/2-14	21,6	27,0	
1202229	-0812	SN	08	13,0	1/2"	12	3/4-14	24,6	32,0	
1214195	-1010	CR	10	16,0	5/8"	10	5/8-14	15,3	27,0	
1201684	-1012	CR	10	16,0	5/8"	12	3/4-14	17,6	32,0	
1201570	-1212	CR	12	19,0	3/4"	12	3/4-14	18,1	32,0	
1216659	-1216	CR	12	19,0	3/4"	16	1-11	20,6	38,0	
1201384	-1616	CR	16	25,0	1"	16	1-11	19,9	38,0	

**// H1230310**

**BSPP Banjo  
RNR**

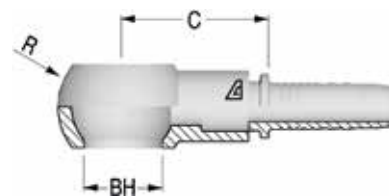

Item Code	Tale/Head		ID		F1	C	BH	R
	Dash	Dash	mm	in				
1203087	-0402	04	6,0	1/4"	1/8-28	20,0	10,10	17
1203086	-0404	04	6,0	1/4"	1/4-19	26,5	13,30	22
1216840	-0406	04	6,0	1/4"	3/8-19	30,5	16,70	28
1201763	-0506	05	8,0	5/16"	3/8-19	30,5	16,70	28
1201760	-0606	06	10,0	3/8"	3/8-19	30,5	16,70	28
1201754	-0608	06	10,0	3/8"	1/2-14	34,5	21,00	38
1216843	-0806	08	13,0	1/2"	3/8-19	30,5	16,70	28
1203048	-0808	08	13,0	1/2"	1/2-14	35,0	21,00	38
1203085	-1010	10	16,0	5/8"	5/8-14	38,0	23,00	40
1200423	-1212	12	19,0	3/4"	3/4-14	41,5	26,50	46
1203084	-1616	16	25,0	1"	1-11	50,5	33,30	58

**// H10V0210**

**BSPP Bolt**

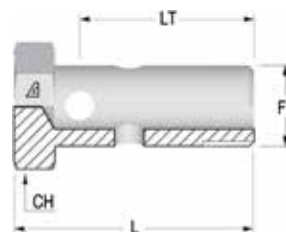

Item Code	ID	F1	LT	L	CH
	Dash		mm	mm	mm
1210365	-	1/2-14	38,0	46,0	27,0
1210366	-	1/4-19	25,0	30,0	19,0
1210367	-	3/8-19	31,0	38,0	22,0
1210402	-	1-11	58,0	69,0	38,0
1210403	-	3/4-14	47,0	56,0	32,0

Dimensions shown may be changed without prior notice

## // DIN METRIC INSERTS

### // H1211110

**Metric Male 24° Seat - Light**  
**DIN 3853 - CEL**

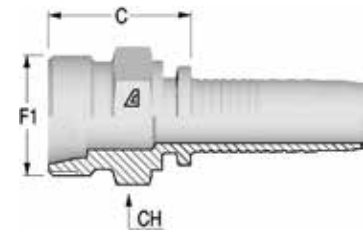

Item Code	Tale/Head Dash/mm	Nut Type	ID			F1	OD1 mm	C mm	CH mm
			Dash	mm	in				
1200451	-0312	NA	03	5,0	3/16"	M12X1.5	6	20,8	14,0
1200481	-0412	NA	04	6,0	1/4"	M12X1.5	6	21,3	14,0
1200482	-0414	NA	04	6,0	1/4"	M14X1.5	8	21,3	14,0
1201558	-0416	NA	04	6,0	1/4"	M16X1.5	10	23,3	17,0
1200518	-0516	NA	05	8,0	5/16"	M16X1.5	10	23,3	17,0
1201086	-0518	NA	05	8,0	5/16"	M18X1.5	12	24,3	19,0
1200314	-0616	NA	06	10,0	3/8"	M16X1.5	10	23,3	17,0
1200315	-0618	NA	06	10,0	3/8"	M18X1.5	12	24,3	19,0
1200320	-0622	NA	06	10,0	3/8"	M22X1.5	15	25,3	22,0
1202565	-0818	NA	08	13,0	1/2"	M18X1.5	12	25,1	19,0
1200358	-0822	NA	08	13,0	1/2"	M22X1.5	15	26,1	22,0
1200362	-0826	NA	08	13,0	1/2"	M26X1.5	18	27,1	27,0
1200401	-1026	NA	10	16,0	5/8"	M26X1.5	18	27,1	27,0
1200432	-1230	NA	12	19,0	3/4"	M30X2	22	31,6	32,0
1201372	-1636	NA	16	25,0	1"	M36X2	28	34,4	36,0
1201373	-2045	NA	20	32,0	1 1/4"	M45X2	35	40,0	46,0
1201374	-2452	NA	24	38,0	1 1/2"	M52X2	42	42,0	55,0

**// H1221513**

**Metric Female 24° Cone with O-Ring - Light  
DIN 3865 - DKOL**

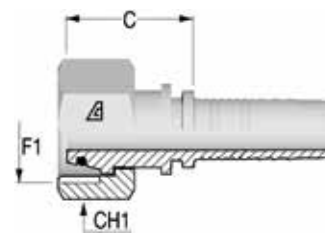

Item Code	Tale/Head Dash/mm	Nut Type	ID		F1	OD1	C	CH1	
			Dash	mm					in
1200595	-0312	SN	03	5,0	3/16"	M12X1.5	6	23,9	14,0
1201612	-0314	SN	03	5,0	3/16"	M14X1.5	8	23,9	17,0
1202944	-0412	CR	04	6,0	1/4"	M12X1.5	6	24,8	14,0
1200614	-0414	SN	04	6,0	1/4"	M14X1.5	8	24,4	17,0
1200609	-0416	SN	04	6,0	1/4"	M16X1.5	10	25,4	19,0
1201060	-0418	SN	04	6,0	1/4"	M18X1.5	12	25,4	22,0
1201458	-0514	SN	05	8,0	5/16"	M14X1.5	8	25,4	17,0
1200642	-0516	SN	05	8,0	5/16"	M16X1.5	10	25,4	19,0
1200643	-0518	SN	05	8,0	5/16"	M18X1.5	12	25,4	22,0
1203152	-0616	SN	06	10,0	3/8"	M16X1.5	10	25,4	19,0
1200667	-0618	SN	06	10,0	3/8"	M18X1.5	12	25,4	22,0
1200670	-0622	SN	06	10,0	3/8"	M22X1.5	15	27,4	27,0
1203260	-0818	SN	08	13,0	1/2"	M18X1.5	12	28,1	22,0
1200707	-0822	SN	08	13,0	1/2"	M22X1.5	15	28,2	27,0
1201843	-0826	SN	08	13,0	1/2"	M26X1.5	18	29,2	32,0
1203158	-1022	SN	10	16,0	5/8"	M22X1.5	15	29,2	27,0
1200736	-1026	SN	10	16,0	5/8"	M26X1.5	18	29,2	32,0
1200760	-1226	SN	12	19,0	3/4"	M26X1.5	18	30,2	32,0
1200762	-1230	SN	12	19,0	3/4"	M30X2	22	31,7	36,0
1220609	-1236	SN	12	19,0	3/4"	M36X2	28	32,8	41,0
1201593	-1630	TN	16	25,0	1"	M30X2	22	44,6	36,0
1201385	-1636	SN	16	25,0	1"	M36X2	28	33,6	41,0
1225980	-1645	SN	16	25,0	1"	M45X2	35	38,5	50,0
1201386	-2045	SN	20	32,0	1 1/4"	M45X2	35	40,1	50,0
1201387	-2452	SN	24	38,0	1 1/2"	M52X2	42	40,5	60,0

Dimensions shown may be changed without prior notice

**// H1221543**

**45° Metric Female 24° Cone with O-Ring - Light  
DIN 3865 - DKOL 45  
Solid one piece**

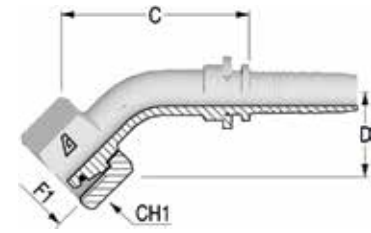

Item Code	Tale/Head Dash/mm	Nut Type	ID			F1	OD1 mm	C mm	D Drop mm	CH1 mm
			Dash	mm	in					
1200594	-0312	SN	03	5,0	3/16"	M12X1.5	6	44,9	19,0	14,0
1216676	-0412	CR	04	6,0	1/4"	M12X1.5	6	45,2	15,5	14,0
1200612	-0414	SN	04	6,0	1/4"	M14X1.5	8	43,0	17,5	17,0
1201576	-0416	SN	04	6,0	1/4"	M16X1.5	10	42,0	20,0	19,0
1225984	-0514	SN	05	8,0	5/16"	M14X1.5	8	47,5	20,0	17,0
1200645	-0516	SN	05	8,0	5/16"	M16X1.5	10	47,5	20,0	19,0
1200646	-0518	SN	05	8,0	5/16"	M18X1.5	12	47,0	22,0	22,0
1239647	-0616	TN	06	10,0	3/8"	M16X1.5	3/8"	43,0	19,0	19,0
1200671	-0618	SN	06	10,0	3/8"	M18X1.5	12	46,8	19,5	22,0
1203326	-0818	SN	08	13,0	1/2"	M18X1.5	12	55,0	21,0	22,0
1200711	-0822	SN	08	13,0	1/2"	M22X1.5	15	55,0	21,0	27,0
1200738	-1026	SN	10	16,0	5/8"	M26X1.5	18	65,3	24,0	32,0
1220810	-1226	SN	12	19,0	3/4"	M26X1.5	18	67,0	28,0	32,0
1200764	-1230	SN	12	19,0	3/4"	M30X2	22	69,4	32,0	36,0
1216677	-1630	SN	16	25,0	1"	M30X2	22	90,0	32,0	36,0
1201390	-1636	SN	16	25,0	1"	M36X2	28	91,4	32,0	41,0
1201392	-2045	SN	20	32,0	1 1/4"	M45X2	35	141,5	45,0	50,0
1202128	-2452	SN	24	38,0	1 1/2"	M52X2	42	114,1	47,0	60,0

**// H1221593**

**90° Metric Female 24° Cone with O-Ring - Light  
DIN 3865 - DKOL 90  
Solid one piece**

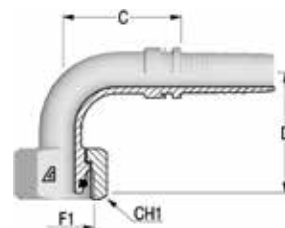

Item Code	Tale/Head Dash/mm	Nut Type	ID			F1	OD1 mm	C mm	D Drop mm	CH1 mm
			Dash	mm	in					
1200597	-0312	SN	03	5,0	3/16"	M12X1.5	-	23,6	33,0	14,0
1203240	-0412	CR	04	6,0	1/4"	M12X1.5	6	29,5	26,0	14,0
1200618	-0414	SN	04	6,0	1/4"	M14X1.5	8	28,3	32,5	17,0
1200616	-0416	SN	04	6,0	1/4"	M16X1.5	10	28,3	32,5	19,0
1203218	-0418	SN	04	6,0	1/4"	M18X1.5	12	28,8	35,0	22,0
1200648	-0516	SN	05	8,0	5/16"	M16X1.5	10	33,7	38,0	19,0
1200649	-0518	SN	05	8,0	5/16"	M18X1.5	12	32,2	40,0	22,0
1200675	-0616	SN	06	10,0	3/8"	M16X1.5	10	32,8	38,0	19,0
1200676	-0618	SN	06	10,0	3/8"	M18X1.5	12	32,8	39,0	22,0
1200679	-0622	SN	06	10,0	3/8"	M22X1.5	15	35,8	38,5	27,0
1238173	-0818	TN	08	13,0	1/2"	M18X1.5	1/2"	42,0	44,0	22,0
1200713	-0822	SN	08	13,0	1/2"	M22X1.5	15	39,8	40,5	27,0
1203154	-0826	SN	08	13,0	1/2"	M26X1.5	18	39,8	41,0	32,0
1201292	-1022	SN	10	16,0	5/8"	M22X1.5	15	51,4	47,0	27,0
1200740	-1026	SN	10	16,0	5/8"	M26X1.5	18	51,4	48,0	32,0
1200742	-1030	SN	10	16,0	5/8"	M30X2	22	52,4	49,0	36,0
1201548	-1226	SN	12	19,0	3/4"	M26X1.5	18	52,1	54,0	32,0
1200767	-1230	SN	12	19,0	3/4"	M30X2	22	52,1	59,0	36,0
1216685	-1236	SN	12	19,0	3/4"	M36X2	28	60,0	63,0	41,0
1216686	-1630	SN	16	25,0	1"	M30X2	22	77,6	63,0	36,0
1201391	-1636	SN	16	25,0	1"	M36X2	28	75,0	68,0	41,0
1216679	-2036	TN	20	32,0	1 1/4"	M36X2	28	92,2	86,0	41,0
1201393	-2045	SN	20	32,0	1 1/4"	M45X2	35	90,5	89,0	50,0
1201394	-2452	SN	24	38,0	1 1/2"	M52X2	42	106,5	100,0	60,0

Dimensions shown may be changed without prior notice

**// H1211210**

**Metric Male 24° Seat - Heavy  
DIN 3853 - CES**

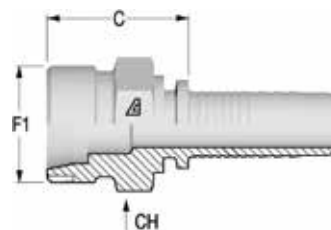

Item Code	Tale/Head Dash/mm	Nut Type	ID		F1	OD1 mm	C mm	CH mm
			Dash	mm in				
1201828	-0414	NA	04	6,0 1/4"	M14X1.5	6	24,3	17,0
1200485	-0416	NA	04	6,0 1/4"	M16X1.5	8	24,3	17,0
1200477	-0418	NA	04	6,0 1/4"	M18X1.5	10	25,3	19,0
1200521	-0520	NA	05	8,0 5/16"	M20X1.5	12	25,3	22,0
1202267	-0618	NA	06	10,0 3/8"	M18X1.5	10	25,3	19,0
1200316	-0620	NA	06	10,0 3/8"	M20X1.5	12	25,3	22,0
1200319	-0622	NA	06	10,0 3/8"	M22X1.5	14	27,3	22,0
1221728	-0624	NA	06	10,0 3/8"	M24X1.5	16	28,1	24,0
1202564	-0822	NA	08	13,0 1/2"	M22X1.5	14	28,1	22,0
1200360	-0824	NA	08	13,0 1/2"	M24X1.5	16	29,1	24,0
1200364	-0830	NA	08	13,0 1/2"	M30X2	20	33,1	32,0
1200403	-1030	NA	10	16,0 5/8"	M30X2	20	33,1	32,0
1202526	-1230	NA	12	19,0 3/4"	M30X2	20	33,6	32,0
1200434	-1236	NA	12	19,0 3/4"	M36X2	25	37,6	36,0
1203151	-1636	NA	16	25,0 1"	M36X2	25	38,4	36,0
1201375	-1642	NA	16	25,0 1"	M42X2	30	42,4	46,0
1201376	-2052	NA	20	32,0 1 1/4"	M52X2	38	48,0	55,0



**// H1221613**

**Metric Female 24° Cone with O-Ring - Heavy  
DIN 3865 - DKOS**

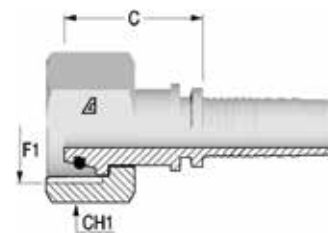

Item Code	Tale/Head Dash/mm	Nut Type	ID			F1	OD1	C	CH1
			Dash	mm	in				
1200596	-0316	SN	03	5,0	3/16"	M16X1.5	8	27,2	19,0
1201827	-0414	SN	04	6,0	1/4"	M14X1.5	6	26,4	17,0
1200615	-0416	SN	04	6,0	1/4"	M16X1.5	8	27,7	19,0
1200610	-0418	SN	04	6,0	1/4"	M18X1.5	10	27,6	22,0
1201061	-0420	SN	04	6,0	1/4"	M20X1.5	12	27,6	24,0
1201832	-0518	SN	05	8,0	5/16"	M18X1.5	10	27,6	22,0
1200644	-0520	SN	05	8,0	5/16"	M20X1.5	12	27,6	24,0
1239671	-0616	TN	06	10,0	3/8"	M16X1.5	-	23,2	19,0
1238179	-0618	TN	06	10,0	3/8"	M18X1.5	3/8"	22,3	22,0
1200668	-0620	SN	06	10,0	3/8"	M20X1.5	12	27,6	24,0
1200669	-0622	SN	06	10,0	3/8"	M22X1.5	14	31,1	27,0
1202570	-0624	SN	06	10,0	3/8"	M24X1.5	16	30,9	30,0
1239650	-0820	TN	08	13,0	1/2"	M20X1.5	1/2"	23,2	24,0
1218557	-0822	SN	08	13,0	1/2"	M22X1.5	14	31,9	27,0
1200708	-0824	SN	08	13,0	1/2"	M24X1.5	16	31,7	30,0
1200710	-0830	SN	08	13,0	1/2"	M30X2	1/2"	36,5	36,0
1239651	-1024	TN	10	16,0	5/8"	M24X1.5	5/8"	25,3	30,0
1200737	-1030	SN	10	16,0	5/8"	M30X2	20	36,5	36,0
1201732	-1230	SN	12	19,0	3/4"	M30X2	20	37,0	36,0
1216696	-1236	SN	12	19,0	3/4"	M36X2	25	40,2	41,0
1200763	-1236	SN	12	19,0	3/4"	M36X2	25	40,2	46,0
1239744	-1630	TN	16	25,0	1"	M30X2	1"	29,8	36,0
1203099	-1636	SN	16	25,0	1"	M36X2	25	41,0	46,0
1201388	-1642	SN	16	25,0	1"	M42X2	30	43,1	50,0
1216693	-2042	SN	20	32,0	1 1/4"	M42X2	30	44,7	50,0
1201389	-2052	SN	20	32,0	1 1/4"	M52X2	38	48,1	60,0
1216695	-2452	SN	24	38,0	1 1/2"	M52X2	38	48,1	60,0

Dimensions shown may be changed without prior notice

**// H1221643**

**45° Metric Female 24° Cone with O-Ring - Heavy  
DIN 3865 - DKOS 45  
Solid one piece**

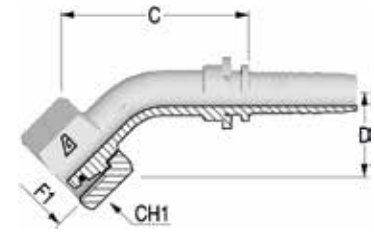

Item Code	Tale/Head Dash/mm	Nut Type	ID			F1	OD1 mm	C mm	D Drop mm	CH1 mm
			Dash	mm	in					
1216697	-0414	SN	04	6,0	1/4"	M14X1.5	6	47,0	20,0	17,0
1200613	-0416	SN	04	6,0	1/4"	M16X1.5	8	48,6	16,0	19,0
1200611	-0418	SN	04	6,0	1/4"	M18X1.5	10	43,5	19,0	22,0
1219110	-0518	SN	05	8,0	5/16"	M18X1.5	10	48,0	20,0	22,0
1200647	-0520	SN	05	8,0	5/16"	M20X1.5	12	48,1	21,0	24,0
1226010	-0616	SN	06	10,0	3/8"	M16X1.5	8	50,6	21,0	19,0
1239968	-0618	TN	06	10,0	3/8"	M18X1.5	3/8"	47,0	21,0	22,0
1200672	-0620	SN	06	10,0	3/8"	M20X1.5	12	50,6	20,0	24,0
1200673	-0622	SN	06	10,0	3/8"	M22X1.5	14	52,9	21,0	27,0
1226012	-0820	SN	08	13,0	1/2"	M20X1.5	12	55,8	21,0	24,0
1200712	-0824	SN	08	13,0	1/2"	M24X1.5	16	55,8	21,5	30,0
1201300	-1030	SN	10	16,0	5/8"	M30X2	20	66,3	30,0	36,0
1202891	-1230	SN	12	19,0	3/4"	M30X2	20	66,1	29,0	36,0
1200765	-1236	SN	12	19,0	3/4"	M36X2	25	69,5	33,0	46,0
1203098	-1636	SN	16	25,0	1"	M36X2	25	89,7	36,0	46,0
1201395	-1642	SN	16	25,0	1"	M42X2	30	110,3	40,5	50,0
1201398	-2052	SN	20	32,0	1 1/4"	M52X2	38	109,0	45,0	60,0

**// H1221693**

**90° Metric Female 24° Cone with O-Ring - Heavy  
DIN 3865 - DKOS 90  
Solid one piece**

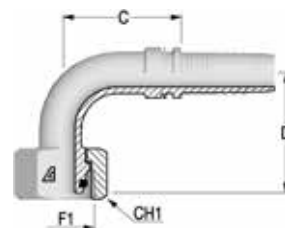

Item Code	Tale/Head Dash/mm	Nut Type	ID			F1	OD1 mm	C mm	D Drop mm	CH1 mm
			Dash	mm	in					
1201065	-0414	SN	04	6,0	1/4"	M14X1.5	6	27,3	33,0	17,0
1200619	-0416	SN	04	6,0	1/4"	M16X1.5	8	27,3	33,0	19,0
1200617	-0418	SN	04	6,0	1/4"	M18X1.5	10	26,8	34,0	22,0
1201063	-0420	SN	04	6,0	1/4"	M20X1.5	12	34,5	39,0	24,0
1216700	-0518	SN	05	8,0	5/16"	M18X1.5	10	33,2	39,0	22,0
1200650	-0520	SN	05	8,0	5/16"	M20X1.5	12	33,2	39,0	24,0
1216701	-0616	SN	06	10,0	3/8"	M16X1.5	8	34,3	39,0	19,0
1239926	-0618	TN	06	10,0	3/8"	M18X1.5	3/8"	35,0	38,0	22,0
1200677	-0620	SN	06	10,0	3/8"	M20X1.5	12	34,3	38,5	24,0
1200678	-0622	SN	06	10,0	3/8"	M22X1.5	14	34,3	40,5	27,0
1200714	-0824	SN	08	13,0	1/2"	M24X1.5	16	39,8	41,5	30,0
1201253	-0830	SN	08	13,0	1/2"	M30X2	20	45,8	50,0	36,0
1240088	-1024	TN	10	16,0	5/8"	M24X1.5	5/8"	52,0	56,0	30,0
1200741	-1030	SN	10	16,0	5/8"	M30X2	20	47,9	55,0	36,0
1200766	-1230	SN	12	19,0	3/4"	M30X2	20	50,6	58,0	36,0
1216711	-1236	SN	12	19,0	3/4"	M36X2	25	50,6	59,5	41,0
1200768	-1236	SN	12	19,0	3/4"	M36X2	25	50,6	59,5	46,0
1203097	-1636	SN	16	25,0	1"	M36X2	25	77,6	73,5	46,0
1201396	-1642	SN	16	25,0	1"	M42X2	30	75,6	79,0	50,0
1203096	-2042	SN	20	32,0	1 1/4"	M42X2	30	95,0	88,0	50,0
1201397	-2052	SN	20	32,0	1 1/4"	M52X2	38	94,0	92,0	60,0

Dimensions shown may be changed without prior notice

**// H1221313**  
**Universal Metric Female**

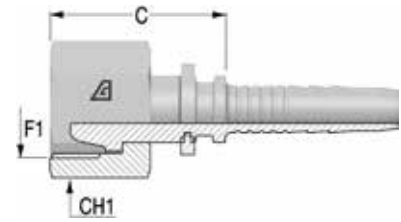

Item Code	Tale/Head Dash	Nut Type	ID			F1		F1	C	CH1
			Dash	mm	in	Dash Size	mm			
1200631	-0414	SN	04	6,0	1/4"	14	M14X1.5	22,3	17,0	
1200632	-0416	SN	04	6,0	1/4"	16	M16X1.5	21,8	19,0	
1200633	-0418	SN	04	6,0	1/4"	18	M18X1.5	22,3	22,0	
1200658	-0516	SN	05	8,0	5/16"	16	M16X1.5	22,3	19,0	
1200659	-0518	SN	05	8,0	5/16"	18	M18X1.5	22,3	22,0	
1200697	-0616	SN	06	10,0	3/8"	16	M16X1.5	25,0	19,0	
1200698	-0618	SN	06	10,0	3/8"	18	M18X1.5	22,3	22,0	
1200729	-0822	SN	08	13,0	1/2"	22	M22X1.5	24,7	27,0	
1200753	-1026	SN	10	16,0	5/8"	26	M26X1.5	25,1	32,0	

**// H1221343**  
**45° Universal Metric Female**

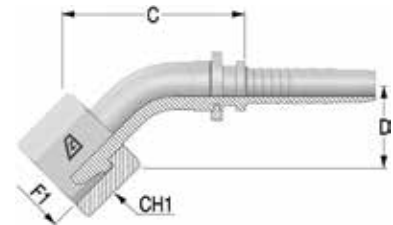

Item Code	Tale/Head Dash	Nut Type	ID			F1		F1	C	D Drop	CH1
			Dash	mm	in	Dash Size	mm				
1216669	-0414	SN	04	6,0	1/4"	14	M14X1.5	36,5	16,0	17,0	
1216670	-0416	SN	04	6,0	1/4"	16	M16X1.5	37,0	17,0	19,0	
1200660	-0516	SN	05	8,0	5/16"	16	M16X1.5	42,1	19,0	19,0	
1201450	-0618	SN	06	10,0	3/8"	18	M18X1.5	42,8	20,0	22,0	
1225972	-0822	SN	08	13,0	1/2"	22	M22X1.5	54,9	20,0	27,0	
1225973	-1026	SN	10	16,0	5/8"	26	M26X1.5	54,0	22,0	32,0	

**// H1221393**

**90° Universal Metric Female**

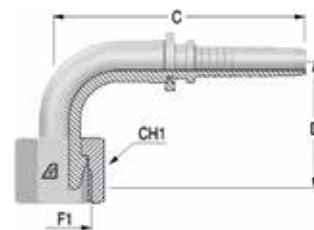

Item Code	Tale/Head Dash	Nut Type	ID			F1		F1	C	D Drop	CH1
			Dash	mm	in	Dash Size					
1225975	-0414	SN	04	6,0	1/4"	14	M14X1.5	29,9	28,5	17,0	
1201452	-0416	SN	04	6,0	1/4"	16	M16X1.5	28,3	33,0	19,0	
1200661	-0516	SN	05	8,0	5/16"	16	M16X1.5	34,2	36,0	19,0	
1201323	-0518	SN	05	8,0	5/16"	18	M18X1.5	34,0	32,0	22,0	
1216671	-0616	SN	06	10,0	3/8"	16	M16X1.5	30,0	32,0	19,0	
1200701	-0618	SN	06	10,0	3/8"	18	M18X1.5	32,8	37,0	22,0	
1201580	-0622	SN	06	10,0	3/8"	22	M22X1.5	32,3	36,0	27,0	
1200730	-0822	SN	08	13,0	1/2"	22	M22X1.5	39,8	40,0	27,0	
1216672	-1026	SN	10	16,0	5/8"	26	M26X1.5	51,0	46,0	32,0	

**// H1221013**

**Metric Female 60° Cone - DIN 3863**

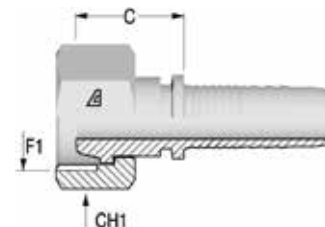

Item Code	Tale/Head Dash	Nut Type	ID			F1		F1	C	CH1
			Dash	mm	in	Dash Size				
1200759	-1230	SN	12	19,0	3/4"	30	M30X1.5	21,6	36,0	
1201572	-1638	SN	16	25,0	1"	38	M38X1.5	28,0	46,0	

**// H1221093**

**90° Metric Female 60° Cone - DIN 3863  
Solid one piece**

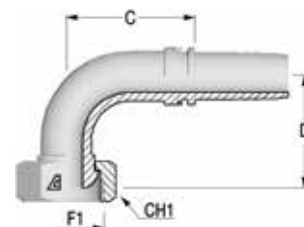

Item Code	Tale/Head Dash	Nut Type	ID			F1		F1	C	D Drop	CH1
			Dash	mm	in	Dash Size					
1202056	-1230	SN	12	19,0	3/4"	30	M30X1.5	54,6	47,0	36,0	
1201620	-1638	SN	16	25,0	1"	38	M38X1.5	72,6	60,0	46,0	

Dimensions shown may be changed without prior notice

**// H1252010**

**Metric Straight Standpipe - DIN 2353  
RSL/RSS**

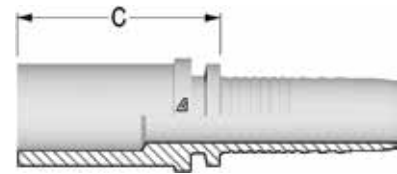

Item Code	Tale/Head	Dash	ID		OD1	C
	Dash/mm		mm	in		
1200855	-0306	03	5,0	3/16"	6	27,8
1200856	-0308	03	5,0	3/16"	8	29,8
1200865	-0406	04	6,0	1/4"	6	28,3
1200867	-0408	04	6,0	1/4"	8	30,2
1200859	-0410	04	6,0	1/4"	10	32,2
1200860	-0412	04	6,0	1/4"	12	31,2
1200878	-0508	05	8,0	5/16"	8	30,3
1200871	-0510	05	8,0	5/16"	10	30,2
1200872	-0512	05	8,0	5/16"	12	32,7
1200793	-0610	06	10,0	3/8"	10	30,3
1200794	-0612	06	10,0	3/8"	12	29,3
1200796	-0614	06	10,0	3/8"	14	35,8
1200797	-0615	06	10,0	3/8"	15	34,8
1216922	-0810	08	13,0	1/2"	10	32,5
1200809	-0812	08	13,0	1/2"	12	32,1
1200811	-0814	08	13,0	1/2"	14	36,1
1200812	-0815	08	13,0	1/2"	15	32,1
1200813	-0816	08	13,0	1/2"	16	37,1
1200815	-0818	08	13,0	1/2"	18	36,0
1200828	-1018	10	16,0	5/8"	18	34,2
1200829	-1020	10	16,0	5/8"	20	44,2
1200832	-1022	10	16,0	5/8"	22	37,2
1200838	-1220	12	19,0	3/4"	20	45,5
1200840	-1222	12	19,0	3/4"	22	36,5
1200841	-1225	12	19,0	3/4"	25	48,5
1201442	-1625	16	25,0	1"	25	51,4
1201440	-1628	16	25,0	1"	28	40,4
1201441	-1630	16	25,0	1"	30	54,4
1214227	-1638	16	25,0	1"	38	60,4
1214228	-2030	20	32,0	1 1/4"	30	56,0
1201443	-2035	20	32,0	1 1/4"	35	48,0
1201444	-2038	20	32,0	1 1/4"	38	62,0
1203082	-2438	24	38,0	1 1/2"	38	62,0
1201445	-2442	24	38,0	1 1/2"	42	52,0

**// H1252040**

**45° Metric Standpipe  
RSL 45/RSS 45 - DIN 2353  
Solid one piece**

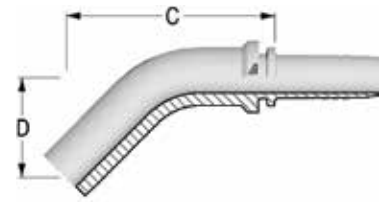

Item Code	Tale/Head	Dash	ID		OD1	C	D Drop
	Dash/mm		mm	in			
1200863	-0406	04	6,0	1/4"	6	50,1	28,0
1200864	-0408	04	6,0	1/4"	8	43,2	23,0
1200862	-0410	04	6,0	1/4"	10	48,0	24,0
1200876	-0510	05	8,0	5/16"	10	48,4	24,0
1200877	-0512	05	8,0	5/16"	12	55,4	28,0
1200800	-0610	06	10,0	3/8"	10	48,5	24,0
1200801	-0612	06	10,0	3/8"	12	55,5	28,0
1200802	-0614	06	10,0	3/8"	14	53,1	28,0
1200817	-0815	08	13,0	1/2"	15	62,6	28,5
1200818	-0816	08	13,0	1/2"	16	63,3	32,0
1214229	-0818	08	13,0	1/2"	18	72,0	30,5
1200843	-1222	12	19,0	3/4"	22	74,3	37,0
1200844	-1225	12	19,0	3/4"	25	83,0	44,0
1216924	-1625	16	25,0	1"	25	102,3	55,0
1214232	-1630	16	25,0	1"	30	137,0	46,1

Dimensions shown may be changed without prior notice

**// H1252090**

**90° Metric Standpipe**  
**RSL 90/RSS 90 - DIN 2353**  
**Solid one piece**

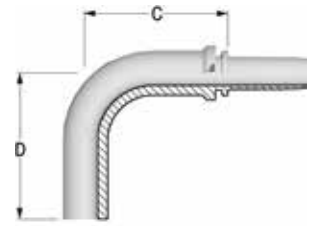

Item Code	Tale/Head	Dash	ID		OD1	C	D Drop
	Dash/mm		mm	in			
1200857	-0306	03	5,0	3/16"	6	24,5	36,0
1200869	-0406	04	6,0	1/4"	6	25,4	36,0
1200870	-0408	04	6,0	1/4"	8	25,9	44,0
1200868	-0410	04	6,0	1/4"	10	30,6	42,0
1202296	-0412	04	6,0	1/4"	12	34,9	50,0
1200879	-0510	05	8,0	5/16"	10	28,6	48,5
1200880	-0512	05	8,0	5/16"	12	39,4	55,0
1200803	-0610	06	10,0	3/8"	10	30,7	42,0
1200804	-0612	06	10,0	3/8"	14	35,0	50,0
1200805	-0614	06	10,0	3/8"	14	37,0	50,0
1218454	-0812	08	13,0	1/2"	12	41,1	52,0
1200822	-0815	08	13,0	1/2"	15	44,7	57,0
1200823	-0816	08	13,0	1/2"	16	43,7	64,0
1203079	-0818	08	13,0	1/2"	18	58,1	59,0
1200835	-1018	10	16,0	5/8"	18	52,2	58,0
1200836	-1020	10	16,0	5/8"	20	62,6	70,0
1210832	-1022	10	16,0	5/8"	22	49,4	64,0
1203081	-1220	12	19,0	3/4"	20	63,4	70,0
1200846	-1222	12	19,0	3/4"	22	53,1	67,5
1200847	-1225	12	19,0	3/4"	25	63,2	85,0
1214233	-1625	16	25,0	1"	25	73,1	98,5
1202886	-1628	16	25,0	1"	28	73,1	89,5
1214234	-1630	16	25,0	1"	30	73,1	102,5
1214235	-2035	20	32,0	1 1/4"	35	89,0	106,5



**// H1230910**

**Metric Banjo  
RNM**

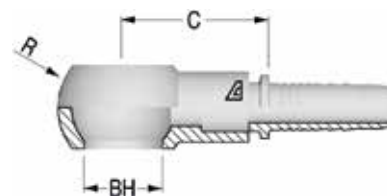

Item Code	Tale/Head		ID		F1	C	BH	R
	Dash	Dash	mm	in				
1202577	-0310	03	5,0	3/16"	M10X1.0	24,0	10,00	17
1200468	-0410	04	6,0	1/4"	M10X1.0	25,0	10,00	17
1200469	-0412	04	6,0	1/4"	M12X1.5	28,5	12,00	20
1200470	-0414	04	6,0	1/4"	M14X1.5	27,5	14,00	24
1200513	-0512	05	8,0	5/16"	M12X1.5	28,5	12,00	24
1200514	-0514	05	8,0	5/16"	M14X1.5	27,5	14,00	24
1200515	-0516	05	8,0	5/16"	M16X1.5	30,5	16,00	28
1200516	-0518	05	8,0	5/16"	M18X1.5	28,5	18,00	32
1200309	-0614	06	10,0	3/8"	M14X1.5	27,5	14,00	24
1200310	-0616	06	10,0	3/8"	M16X1.5	30,5	16,00	28
1200311	-0618	06	10,0	3/8"	M18X1.5	31,5	18,00	32
1200346	-0818	08	13,0	1/2"	M18X1.5	32,0	18,00	32
1200347	-0822	08	13,0	1/2"	M22X1.5	35,0	22,00	39
1200389	-1022	10	16,0	5/8"	M22X1.5	35,0	22,00	39
1200422	-1226	12	19,0	3/4"	M26X1.5	38,5	26,00	46
1203083	-1630	16	25,0	1"	M30X1.5	42,5	30,00	54

**// H10V0810**

**Metric Bolt**

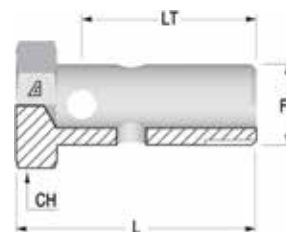

Item Code	ID	F1	LT	L	CH
	Dash				
1210405	-	M30X1.5	51,0	62,0	38,0
1210406	-	M26X1.5	42,0	52,0	32,0
1210371	-	M22X1.5	41,0	48,0	27,0
1210384	-	M16X1.5	34,0	41,0	22,0
1210374	-	M10X1.0	19,0	24,0	14,0
1210375	-	M12X1.5	24,0	29,0	17,0
1210368	-	M14X1.5	28,0	34,0	19,0
1210369	-	M18X1.5	37,0	44,0	24,0

Dimensions shown may be changed without prior notice

## // PRESSURE WASHER

### // H1224914

Universal Female for Pressure Washer

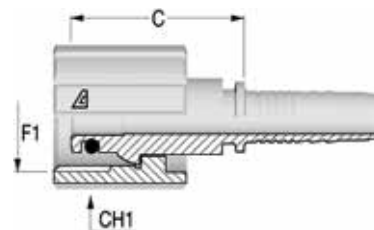

Item Code	Tale/Head Dash	Nut Type	ID		F1		F1	C	CH1
			Dash	mm	in	Dash Size			
1203350	-0422	TN	04	6,0	1/4"	22	M22X1.5	36,8	35,0
1203351	-0522	TN	05	8,0	5/16"	22	M22X1.5	36,8	35,0
1203352	-0622	TN	06	10,0	3/8"	22	M22X1.5	36,8	35,0

## // SAE INSERTS

### // H1213B10

SAE Male Flareless

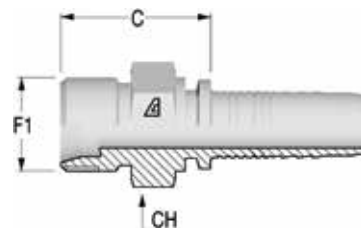

Item Code	Tale/Head Dash	Nut Type	ID			F1 Dash Size	F1	C	CH
			Dash	mm	in				
1216628	-0404	NA	04	6,0	1/4"	04	7/16-20	21,8	12,0
1216629	-0405	NA	04	6,0	1/4"	05	1/2-20	22,8	14,0
1216630	-0506	NA	05	8,0	5/16"	06	9/16-18	24,2	16,0
1216632	-0606	NA	06	10,0	3/8"	06	9/16-18	24,2	16,0
1216633	-0808	NA	08	13,0	1/2"	08	3/4-16	28,4	22,0
1225942	-1212	NA	12	19,0	3/4"	12	1 1/16-12	33,1	30,0

### // H1226611

SAE Female Swivel 45° Seat

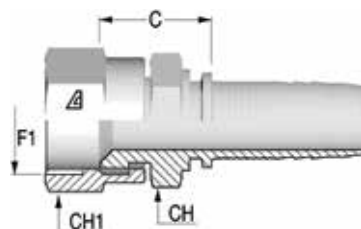

Item Code	Tale/Head Dash	Nut Type	ID			F1 Dash Size	F1	C	CH	CH1
			Dash	mm	in					
1202661	-0606	CR	06	10,0	3/8"	06	5/8-18	23,3	19,0	22,0
1226097	-0608	CR	06	10,0	3/8"	08	3/4-16	24,8	19,0	25,0
1226098	-0810	CR	08	13,0	1/2"	10	7/8-14	26,6	22,0	27,0
1202371	-1212	CR	12	19,0	3/4"	12	1 1/16-14	28,6	27,0	32,0

### // H1229710

Female Grease Connection PTF Thread

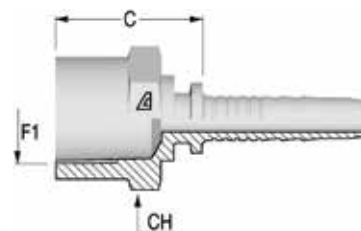

Item Code	Tale/Head Dash	Nut Type	ID			F1 Dash Size	F1	C	CH
			Dash	mm	in				
1216837	-0404	NA	04	6,0	1/4"	04	1/2-27	23,3	19,0

Dimensions shown may be changed without prior notice

**// H1213010**  
**SAE Male Solid**  
**O-Ring Boss**

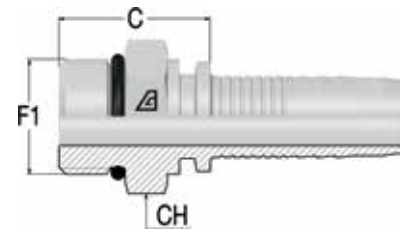

Item Code	Tale/Head Dash	Nut Type	ID		F1		F1	C	CH
			Dash	mm	in	Dash Size			
1203147	-0404	NA	04	6,0	1/4"	04	7/16-20	20,3	14,0
1201833	-0405	NA	04	6,0	1/4"	05	1/2-20	21,3	16,0
1202519	-0406	NA	04	6,0	1/4"	06	9/16-18	22,3	17,0
1201834	-0606	NA	06	10,0	3/8"	06	9/16-18	23,3	19,0
1200337	-0608	NA	06	10,0	3/8"	08	3/4-16	24,3	22,0
1200338	-0610	NA	06	10,0	3/8"	10	7/8-14	26,8	27,0
1200382	-0808	NA	08	13,0	1/2"	08	3/4-16	25,1	22,0
1200383	-0810	NA	08	13,0	1/2"	10	7/8-14	27,6	27,0
1200381	-0812	NA	08	13,0	1/2"	12	1 1/16-12	32,1	32,0
1221652	-1010	NA	10	16,0	5/8"	10	7/8-14	27,6	24,0
1200416	-1012	NA	10	16,0	5/8"	12	1 1/16-12	32,1	32,0
1203146	-1210	NA	12	19,0	3/4"	10	7/8-14	28,1	27,0
1200445	-1212	NA	12	19,0	3/4"	12	1 1/16-12	32,6	32,0
1201836	-1616	NA	16	25,0	1"	16	1 5/16-12	35,4	38,0
1225859	-2020	NA	20	32,0	1 1/4"	20	1 5/8-12	39,0	46,0

**// H1213011**  
**SAE Male Swivel**  
**O-Ring Boss**

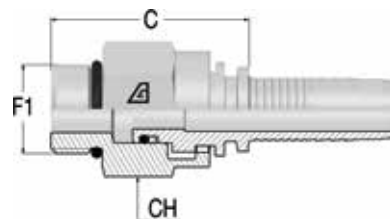

Item Code	Tale/Head Dash	Nut Type	ID			F1		C	CH
			Dash	mm	in	Dash Size	F1		
1225927	-0606	CR	06	10,0	3/8"	06	9/16-18	40,5	22,0
1225928	-0608	CR	06	10,0	3/8"	08	3/4-16	22,0	22,0
1225929	-0808	CR	08	13,0	1/2"	08	3/4-16	23,0	25,0
1225930	-0810	CR	08	13,0	1/2"	10	7/8-14	23,0	25,0
1230553	-1212	CR	12	19,0	3/4"	12	1 1/16-12	49,6	32,0

**// H1213081**  
**90° Compact SAE Male Swivel**  
**O-Ring Boss**

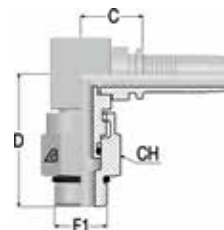

Item Code	Tale/Head Dash	Nut Type	ID			F1		C	D Drop	CH
			Dash	mm	in	Dash Size	F1			
1226490	-0405	CR	04	6,0	1/4"	05	1/2-20	17,0	34,0	17,0
1225933	-0608	CR	06	10,0	3/8"	08	3/4-16	22,0	44,0	25,0
1225934	-0808	CR	08	13,0	1/2"	08	3/4-16	23,0	47,0	25,0
1225935	-0810	CR	08	13,0	1/2"	10	7/8-14	23,0	49,0	25,0
1226492	-1212	CR	12	19,0	3/4"	12	1 1/16-12	27,0	61,0	32,0
1240593	-1616	CR	16	25,0	1"	16	1 5/16-12	-	-	41,0

Dimensions shown may be changed without prior notice

## // JIC 37° INSERTS

### // H1212510

JIC Male 37° Cone  
AGJ

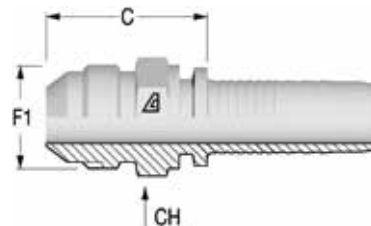

Item Code	Tale/Head	Nut Type	ID			F1	F1	C	CH
	Dash		Dash	mm	in	Dash Size			
1200457	-0304	NA	03	5,0	3/16"	04	7/16-20	23,8	12,0
1200500	-0404	NA	04	6,0	1/4"	04	7/16-20	25,3	12,0
1200499	-0405	NA	04	6,0	1/4"	05	1/2-20	25,3	14,0
1200501	-0406	NA	04	6,0	1/4"	06	9/16-18	26,3	17,0
1200534	-0505	NA	05	8,0	5/16"	05	1/2-20	25,3	14,0
1200535	-0506	NA	05	8,0	5/16"	06	9/16-18	26,3	17,0
1201087	-0508	NA	05	8,0	5/16"	08	3/4-16	29,8	19,0
1200332	-0606	NA	06	10,0	3/8"	06	9/16-18	26,3	17,0
1200330	-0608	NA	06	10,0	3/8"	08	3/4-16	29,8	19,0
1200331	-0610	NA	06	10,0	3/8"	10	7/8-14	33,8	24,0
1200375	-0808	NA	08	13,0	1/2"	08	3/4-16	30,6	19,0
1200376	-0810	NA	08	13,0	1/2"	10	7/8-14	34,6	24,0
1200374	-0812	NA	08	13,0	1/2"	12	1 1/16-12	37,1	27,0
1200413	-1010	NA	10	16,0	5/8"	10	7/8-14	34,6	24,0
1200411	-1012	NA	10	16,0	5/8"	12	1 1/16-12	37,1	27,0
1200441	-1212	NA	12	19,0	3/4"	12	1 1/16-12	37,6	27,0
1200442	-1214	NA	12	19,0	3/4"	14	1 3/16-12	40,1	32,0
1200443	-1216	NA	12	19,0	3/4"	16	1 5/16-12	42,6	36,0
1222989	-1612	NA	16	25,0	1"	12	1 1/16-12	40,4	32,0
1201379	-1616	NA	16	25,0	1"	16	1 5/16-12	43,4	36,0
1201380	-1620	NA	16	25,0	1"	20	1 5/8-12	46,9	46,0
1201381	-2020	NA	20	32,0	1 1/4"	20	1 5/8-12	48,5	46,0
1201785	-2024	NA	20	32,0	1 1/4"	24	1 7/8-12	52,5	50,0
1201382	-2424	NA	24	38,0	1 1/2"	24	1 7/8-12	52,5	50,0
1201383	-3232	NA	32	51,0	2"	32	2 1/2-12	62,0	65,0

**// H1222511**

**JIC Female 37° Seat  
DKJ**

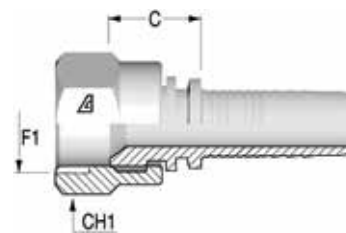

Item Code	Tale/Head	Nut Type	ID			F1	F1	C	CH1
	Dash		Dash	mm	in	Dash Size			
1200600	-0304	CR	03	5,0	3/16"	04	7/16-20	14,3	16,0
1200625	-0404	CR	04	6,0	1/4"	04	7/16-20	14,6	16,0
1200623	-0405	CR	04	6,0	1/4"	05	1/2-20	15,3	17,0
1200626	-0406	CR	04	6,0	1/4"	06	9/16-18	15,3	19,0
1200655	-0505	CR	05	8,0	5/16"	05	1/2-20	15,3	17,0
1200656	-0506	CR	05	8,0	5/16"	06	9/16-18	15,3	19,0
1200691	-0606	CR	06	10,0	3/8"	06	9/16-18	15,3	19,0
1200687	-0608	CR	06	10,0	3/8"	08	3/4-16	17,8	25,0
1200690	-0610	CR	06	10,0	3/8"	10	7/8-14	20,3	27,0
1200723	-0808	CR	08	13,0	1/2"	08	3/4-16	18,6	25,0
1200725	-0810	CR	08	13,0	1/2"	10	7/8-14	19,6	27,0
1200722	-0812	CR	08	13,0	1/2"	12	1 1/16-12	22,1	32,0
1200751	-1010	CR	10	16,0	5/8"	10	7/8-14	19,6	27,0
1200749	-1012	CR	10	16,0	5/8"	12	1 1/16-12	20,1	32,0
1201841	-1210	CR	12	19,0	3/4"	10	7/8-14	20,1	27,0
1200774	-1212	CR	12	19,0	3/4"	12	1 1/16-12	20,6	32,0
1200775	-1214	CR	12	19,0	3/4"	14	1 3/16-12	19,9	36,0
1200776	-1216	CR	12	19,0	3/4"	16	1 5/16-12	22,1	38,0
1201399	-1612	CR	16	25,0	1"	12	1 1/16-12	22,4	32,0
1201400	-1616	CR	16	25,0	1"	16	1 5/16-12	23,9	38,0
1201401	-1620	TN	16	25,0	1"	20	1 5/8-12	26,5	50,0
1202820	-2016	CR	20	32,0	1 1/4"	16	1 5/16-12	26,5	38,0
1201402	-2020	TN	20	32,0	1 1/4"	20	1 5/8-12	28,1	50,0
1201403	-2024	TN	20	32,0	1 1/4"	24	1 7/8-12	30,4	55,0
1201097	-2424	TN	24	38,0	1 1/2"	24	1 7/8-12	29,4	55,0
1203249	-3224	TN	32	51,0	2"	24	1 7/8-12	31,4	55,0
1201404	-3232	TN	32	51,0	2"	32	2 1/2-12	32,0	-

Dimensions shown may be changed without prior notice

**// H1226511**

**JIC Female 37° Seat with Stem Hexagon  
DKJ**

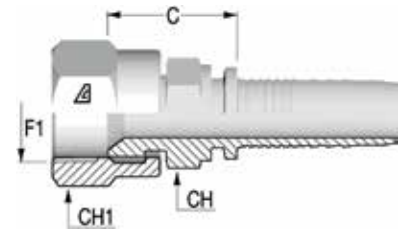

Item Code	Tale/Head Dash	Nut Type	ID		F1		F1	C	CH	CH1
			Dash	mm	in	Dash Size				
1200599	-0304	CR	03	5,0	3/16"	04	7/16-20	18,1	12,0	16,0
1200621	-0404	CR	04	6,0	1/4"	04	7/16-20	19,6	14,0	16,0
1202406	-0405	CR	04	6,0	1/4"	05	1/2-20	20,3	14,0	17,0
1200622	-0406	CR	04	6,0	1/4"	06	9/16-18	20,3	14,0	19,0
1201497	-0505	CR	05	8,0	5/16"	05	1/2-20	20,3	14,0	17,0
1201264	-0506	CR	05	8,0	5/16"	06	9/16-18	20,3	14,0	19,0
1203246	-0604	CR	06	10,0	3/8"	04	7/16-20	20,6	17,0	16,0
1223146	-0605	CR	06	10,0	3/8"	05	1/2-20	21,3	16,0	17,0
1242000	-0606	CR	06	10,0	3/8"	06	9/16-18	21,3	17,0	19,0
1200686	-0606	CR	06	10,0	3/8"	06	9/16-18	21,3	17,0	19,0
1200685	-0608	CR	06	10,0	3/8"	08	3/4-16	24,8	19,0	25,0
1241996	-0608	CR	06	10,0	3/8"	08	3/4-16	24,8	19,0	25,0
1201340	-0610	CR	06	10,0	3/8"	10	7/8-14	25,8	22,0	27,0
1203090	-0806	CR	08	13,0	1/2"	06	9/16-18	23,1	19,0	19,0
1242136	-0808	CR	08	13,0	1/2"	08	3/4-16	25,6	19,0	25,0
1200720	-0808	CR	08	13,0	1/2"	08	3/4-16	25,6	19,0	25,0
1200721	-0810	CR	08	13,0	1/2"	10	7/8-14	26,6	22,0	27,0
1210833	-0812	CR	08	13,0	1/2"	12	1 1/16-12	28,1	25,0	32,0
1241997	-0812	CR	08	13,0	1/2"	12	1 1/16-12	28,1	25,0	32,0
1216811	-1006	CR	10	16,0	5/8"	06	9/16-18	24,1	24,0	19,0
1203329	-1008	CR	10	16,0	5/8"	08	3/4-16	26,6	24,0	25,0
1201728	-1010	CR	10	16,0	5/8"	10	7/8-14	27,6	24,0	27,0
1201464	-1012	CR	10	16,0	5/8"	12	1 1/16-12	28,1	25,0	32,0
1202895	-1210	CR	12	19,0	3/4"	10	7/8-14	28,1	27,0	27,0
1241998	-1212	CR	12	19,0	3/4"	12	1 1/16-12	28,6	27,0	32,0
1201333	-1212	CR	12	19,0	3/4"	12	1 1/16-12	28,6	27,0	32,0
1214219	-1214	CR	12	19,0	3/4"	14	1 3/16-12	29,9	32,0	36,0
1203089	-1216	CR	12	19,0	3/4"	16	1 5/16-12	32,1	32,0	38,0
1203243	-1416	CR	14	22,0	7/8"	16	1 5/16-12	32,1	32,0	38,0
1203088	-1612	CR	16	25,0	1"	12	1 1/16-12	31,4	32,0	32,0
1202408	-1616	CR	16	25,0	1"	16	1 5/16-12	32,9	32,0	38,0
1214220	-1620	TN	16	25,0	1"	20	1 5/8-12	37,5	41,0	50,0
1216813	-1820	TN	-	29,0	1 1/8"	20	1 5/8-12	37,5	41,0	50,0
1216812	-2016	CR	20	32,0	1 1/4"	16	1 5/16-12	37,5	41,0	38,0
1202483	-2020	TN	20	32,0	1 1/4"	20	1 5/8-12	39,1	41,0	50,0
1226093	-2024	TN	20	32,0	1 1/4"	24	1 7/8-12	43,4	50,0	55,0
1216814	-2224	TN	-	35,0	1 3/8"	24	1 7/8-12	43,4	50,0	55,0
1216815	-2424	TN	24	38,0	1 1/2"	24	1 7/8-12	43,4	50,0	55,0
1216816	-3232	TN	32	51,0	2"	32	2 1/2-12	49,0	65,0	70,0



**// H1222541-M**

**45° JIC Female 37° Seat - Medium Drop  
DKJ 45M  
Solid one piece**

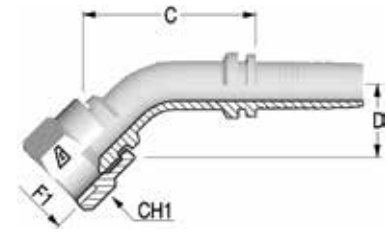

Item Code	Tale/Head Dash	Nut Type	ID		F1		F1	C	D Drop	CH1
			Dash	mm	in	Dash Size				
1202821	-0304	CR	03	5,0	3/16"	04	7/16-20	37,1	10,0	16,0
1202822	-0404	CR	04	6,0	1/4"	04	7/16-20	36,6	10,0	16,0
1202823	-0405	CR	04	6,0	1/4"	05	1/2-20	37,2	12,0	17,0
1202824	-0406	CR	04	6,0	1/4"	06	9/16-18	39,4	11,0	19,0
1202825	-0505	CR	05	8,0	5/16"	05	1/2-20	39,8	12,0	17,0
1202826	-0506	CR	05	8,0	5/16"	06	9/16-18	42,8	12,0	19,0
1202827	-0606	CR	06	10,0	3/8"	06	9/16-18	46,3	11,0	19,0
1202791	-0608	CR	06	10,0	3/8"	08	3/4-16	47,2	15,0	25,0
1241992	-0608	CR	06	10,0	3/8"	08	3/4-16	47,2	15,0	25,0
1202828	-0808	CR	08	13,0	1/2"	08	3/4-16	51,6	15,0	25,0
1202829	-0810	CR	08	13,0	1/2"	10	7/8-14	50,7	16,0	27,0
1202830	-0812	CR	08	13,0	1/2"	12	1 1/16-12	57,0	21,0	32,0
1202832	-1010	CR	10	16,0	5/8"	10	7/8-14	62,2	19,0	27,0
1202831	-1012	CR	10	16,0	5/8"	12	1 1/16-12	68,6	21,0	32,0
1202833	-1212	CR	12	19,0	3/4"	12	1 1/16-12	67,5	21,0	32,0
1200778	-1214	CR	12	19,0	3/4"	14	1 3/16-12	67,6	23,0	36,0
1202834	-1216	CR	12	19,0	3/4"	16	1 5/16-12	71,4	26,0	38,0
1202835	-1616	CR	16	25,0	1"	16	1 5/16-12	79,4	24,0	38,0
1202836	-1620	TN	16	25,0	1"	20	1 5/8-12	83,8	37,0	50,0
1202837	-2020	TN	20	32,0	1 1/4"	20	1 5/8-12	97,1	37,0	50,0
1202839	-2424	TN	24	38,0	1 1/2"	24	1 7/8-12	112,7	43,0	55,0
1202840	-3232	TN	32	51,0	2"	32	2 1/2-12	159,9	67,0	70,0

Dimensions shown may be changed without prior notice

**// H1222591-S**

**90° JIC Female 37° Seat - Short Drop  
DKJ 90S  
Solid one piece**

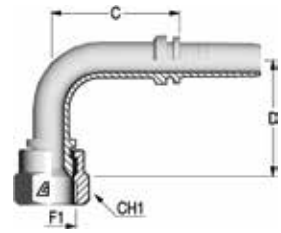

Item Code	Tale/Head Dash	Nut Type	ID		F1		F1	C	D Drop	CH1
			Dash	mm	in	Dash Size				
1202841	-0304	CR	03	5,0	3/16"	04	7/16-20	26,7	21,0	16,0
1202772	-0404	CR	04	6,0	1/4"	04	7/16-20	27,0	21,0	16,0
1203118	-0405	CR	04	6,0	1/4"	05	1/2-20	26,5	23,5	17,0
1202788	-0406	CR	04	6,0	1/4"	06	9/16-18	31,0	23,0	19,0
1203116	-0506	CR	05	8,0	5/16"	06	9/16-18	42,7	23,0	19,0
1216771	-0605	CR	06	10,0	3/8"	05	1/2-20	33,3	25,0	17,0
1203032	-0606	CR	06	10,0	3/8"	06	9/16-18	42,3	25,0	19,0
1203033	-0608	CR	06	10,0	3/8"	08	3/4-16	48,8	29,0	25,0
1216773	-0806	CR	08	13,0	1/2"	06	9/16-18	48,0	23,0	19,0
1203034	-0808	CR	08	13,0	1/2"	08	3/4-16	46,4	29,0	25,0
1202815	-0810	CR	08	13,0	1/2"	10	7/8-14	45,8	32,0	27,0
1202744	-0812	CR	08	13,0	1/2"	12	1 1/16-12	37,3	46,0	32,0
1203035	-1010	CR	10	16,0	5/8"	10	7/8-14	36,5	32,0	27,0
1202745	-1012	CR	10	16,0	5/8"	12	1 1/16-12	47,9	48,0	32,0
1202845	-1212	CR	12	19,0	3/4"	12	1 1/16-12	58,2	46,0	32,0
1200780	-1214	CR	12	19,0	3/4"	14	1 3/16-12	49,6	52,5	36,0
1202846	-1216	CR	12	19,0	3/4"	16	1 5/16-12	53,6	53,0	38,0
1203036	-1616	CR	16	25,0	1"	16	1 5/16-12	74,0	56,0	38,0

**// H1222591-M**

**90° JIC Female 37° Seat - Medium Drop  
DKJ 90M  
Solid one piece**

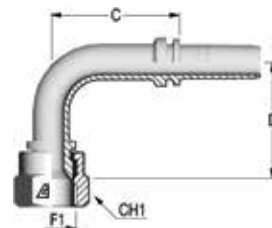

Item Code	Tale/Head	Nut Type	ID			F1		F1	C	D Drop	CH1
	Dash		Dash	mm	in	Dash Size	mm				
1202792	-0304	CR	03	5,0	3/16"	04	7/16-20	33,5	32,0	16,0	
1202739	-0404	CR	04	6,0	1/4"	04	7/16-20	34,2	32,0	16,0	
1202740	-0405	CR	04	6,0	1/4"	05	1/2-20	25,7	30,0	17,0	
1202793	-0406	CR	04	6,0	1/4"	06	9/16-18	28,5	38,0	19,0	
1202794	-0505	CR	05	8,0	5/16"	05	1/2-20	34,2	32,0	17,0	
1202731	-0506	CR	05	8,0	5/16"	06	9/16-18	33,2	35,0	19,0	
1202742	-0606	CR	06	10,0	3/8"	06	9/16-18	31,3	35,0	19,0	
1241994	-0608	CR	06	10,0	3/8"	08	3/4-16	39,5	41,0	25,0	
1202732	-0608	CR	06	10,0	3/8"	08	3/4-16	39,5	41,0	25,0	
1200693	-0610	CR	06	10,0	3/8"	10	7/8-14	44,6	47,0	27,0	
1202743	-0808	CR	08	13,0	1/2"	08	3/4-16	37,2	40,0	25,0	
1202741	-0810	CR	08	13,0	1/2"	10	7/8-14	43,3	47,0	27,0	
1202869	-0812	CR	08	13,0	1/2"	12	1 1/16-12	42,8	58,0	32,0	
1202844	-1010	CR	10	16,0	5/8"	10	7/8-14	49,4	48,0	27,0	
1216778	-1012	CR	10	16,0	5/8"	12	1 1/16-12	47,9	58,0	32,0	
1202746	-1212	CR	12	19,0	3/4"	12	1 1/16-12	52,4	54,0	32,0	
1216780	-1216	CR	12	19,0	3/4"	16	1 5/16-12	52,6	72,0	38,0	
1202847	-1616	CR	16	25,0	1"	16	1 5/16-12	72,6	71,5	38,0	
1202848	-1620	TN	16	25,0	1"	20	1 5/8-12	72,6	78,0	50,0	
1202849	-2020	TN	20	32,0	1 1/4"	20	1 5/8-12	82,4	78,0	50,0	
1202850	-2024	TN	20	32,0	1 1/4"	24	1 7/8-12	87,3	82,0	55,0	
1202851	-2424	TN	24	38,0	1 1/2"	24	1 7/8-12	95,3	92,0	55,0	
1202852	-3232	TN	32	51,0	2"	32	2 1/2-12	129,5	140,0	70,0	

**// H1222591-L**

**90° JIC Female 37° Seat - Long Drop  
DKJ 90L  
Solid one piece**

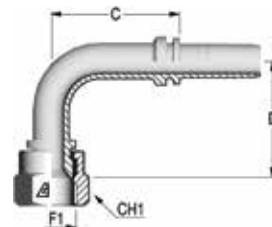

Item Code	Tale/Head	Nut Type	ID			F1		F1	C	D Drop	CH1
	Dash		Dash	mm	in	Dash Size	mm				
1203131	-0404	CR	04	6,0	1/4"	04	7/16-20	30,8	46,0	16,0	
1214215	-0405	CR	04	6,0	1/4"	05	1/2-20	31,3	45,0	17,0	
1202129	-0406	CR	04	6,0	1/4"	06	9/16-18	34,3	54,0	19,0	
1203117	-0506	CR	05	8,0	5/16"	06	9/16-18	36,2	54,0	19,0	
1203115	-0606	CR	06	10,0	3/8"	06	9/16-18	43,3	54,0	19,0	
1202842	-0608	CR	06	10,0	3/8"	08	3/4-16	46,8	64,0	25,0	
1214216	-0808	CR	08	13,0	1/2"	08	3/4-16	49,9	64,0	25,0	
1202843	-0810	CR	08	13,0	1/2"	10	7/8-14	37,3	65,0	27,0	
1203114	-1010	CR	10	16,0	5/8"	10	7/8-14	49,9	65,0	27,0	
1203113	-1012	CR	10	16,0	5/8"	12	1 1/16-12	49,9	96,0	32,0	
1203112	-1212	CR	12	19,0	3/4"	12	1 1/16-12	54,1	95,0	32,0	
1203111	-1616	CR	16	25,0	1"	16	1 5/16-12	78,6	114,0	38,0	

Dimensions shown may be changed without prior notice

## // NPTF INSERTS

### // H1212810

**NPTF Male 60° Seat  
AGN**

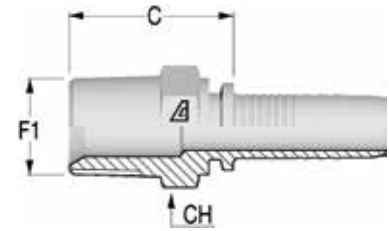

Item Code	Tale/Head	Nut Type	ID			F1	F1	C	CH
	Dash		Dash	mm	in	Dash Size		mm	mm
1200448	-0302	NA	03	5,0	3/16"	02	1/8-27	20,8	12,0
1200466	-0402	NA	04	6,0	1/4"	02	1/8-27	21,3	14,0
1200465	-0404	NA	04	6,0	1/4"	04	1/4-18	26,8	17,0
1200467	-0406	NA	04	6,0	1/4"	06	3/8-18	27,8	19,0
1203150	-0408	NA	04	6,0	1/4"	08	1/2-14	31,3	22,0
1200511	-0504	NA	05	8,0	5/16"	04	1/4-18	26,8	17,0
1200512	-0506	NA	05	8,0	5/16"	06	3/8-18	27,8	19,0
1200307	-0604	NA	06	10,0	3/8"	04	1/4-18	26,8	17,0
1200308	-0606	NA	06	10,0	3/8"	06	3/8-18	27,8	19,0
1200306	-0608	NA	06	10,0	3/8"	08	1/2-14	31,3	22,0
1200345	-0806	NA	08	13,0	1/2"	06	3/8-18	28,6	19,0
1200343	-0808	NA	08	13,0	1/2"	08	1/2-14	32,1	22,0
1200344	-0812	NA	08	13,0	1/2"	12	3/4-14	34,1	27,0
1200387	-1008	NA	10	16,0	5/8"	08	1/2-14	33,1	24,0
1200388	-1012	NA	10	16,0	5/8"	12	3/4-14	34,1	27,0
1203149	-1208	NA	12	19,0	3/4"	08	1/2-14	33,6	27,0
1200421	-1212	NA	12	19,0	3/4"	12	3/4-14	34,6	27,0
1200420	-1216	NA	12	19,0	3/4"	16	1-11 1/2	43,6	36,0
1216610	-1416	NA	14	22,0	7/8"	16	1-11 1/2	43,6	36,0
1202282	-1612	NA	16	25,0	1"	12	3/4-14	39,4	36,0
1201366	-1616	NA	16	25,0	1"	16	1-11 1/2	44,4	36,0
1201367	-1620	NA	16	25,0	1"	20	1 1/4-11 1/2	47,4	46,0
1216611	-1820	NA	-	29,0	1 1/8"	20	1 1/4-11 1/2	47,4	46,0
1201368	-2020	NA	20	32,0	1 1/4"	20	1 1/4-11 1/2	49,0	46,0
1216612	-2224	NA	-	35,0	1 3/8"	24	1 1/2-11 1/2	50,5	50,0
1201369	-2424	NA	24	38,0	1 1/2"	24	1 1/2-11 1/2	50,5	50,0
1216613	-2932	NA	29	46,0	1 3/4"	32	2-11 1/2	54,2	65,0
1201370	-3232	NA	32	51,0	2"	32	2-11 1/2	54,2	65,0

**// H1222810**  
**NPTF Female Solid**

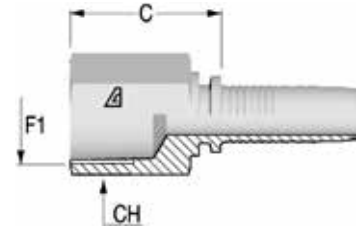

Item Code	Tale/Head Dash	Nut Type	ID			F1		F1	C	CH
			Dash	mm	in	Dash Size	mm			
1216794	-0402	NA	04	6,0	1/4"	02	1/8-27	22,3	14,0	
1200464	-0404	NA	04	6,0	1/4"	04	1/4-18	27,8	19,0	
1219145	-0606	NA	06	10,0	3/8"	06	3/8-18	28,8	22,0	
1216795	-0808	NA	08	13,0	1/2"	08	1/2-14	35,6	25,0	
1216796	-1212	NA	12	19,0	3/4"	12	3/4-14	38,1	32,0	
1216797	-1616	NA	16	25,0	1"	16	1-11 1/2	44,9	38,0	

**// H1212811**  
**NPTF Male Swivel 60° Seat**

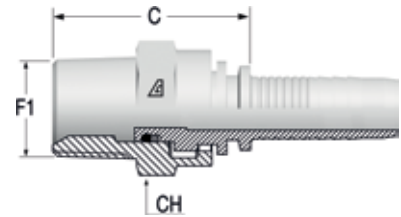

Item Code	Tale/Head Dash	Nut Type	ID			F1		F1	C	CH
			Dash	mm	in	Dash Size	mm			
1216614	-0404	CR	04	6,0	1/4"	04	1/4-18	37,6	17,0	
1216615	-0406	CR	04	6,0	1/4"	06	3/8-18	39,5	22,0	
1216616	-0604	CR	06	10,0	3/8"	04	1/4-18	39,6	17,0	
1214186	-0606	CR	06	10,0	3/8"	06	3/8-18	37,5	22,0	
1216617	-0608	CR	06	10,0	3/8"	08	1/2-14	43,5	25,0	
1216619	-0806	CR	08	13,0	1/2"	06	3/8-18	38,3	22,0	
1214187	-0808	CR	08	13,0	1/2"	08	1/2-14	42,3	25,0	
1216620	-1212	CR	12	19,0	3/4"	12	3/4-14	50,1	32,0	
1216621	-1616	CR	16	25,0	1"	16	1-11 1/2	57,9	41,0	

**// H1212881**  
**90° Compact NPTF Male Swivel 60° Seat**

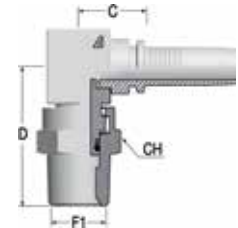

Item Code	Tale/Head Dash	Nut Type	ID			F1		F1	C	D Drop	CH
			Dash	mm	in	Dash Size	mm				
1225918	-0404	CR	04	6,0	1/4"	04	1/4-18	17,0	39,0	17,0	
1225920	-0606	CR	06	10,0	3/8"	06	3/8-18	20,0	41,0	22,0	
1225921	-0808	CR	08	13,0	1/2"	08	1/2-14	23,0	48,0	25,0	
1225922	-1212	CR	12	19,0	3/4"	12	3/4-14	27,0	61,0	32,0	

Dimensions shown may be changed without prior notice

## // NPSM INSERTS

### // H1227311 NPSM Female

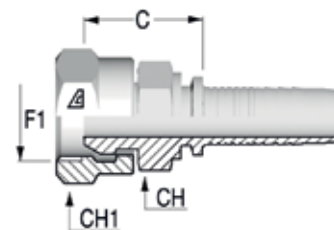

Item Code	Tale/Head Dash	Nut Type	ID			F1		C	CH	CH1
			Dash	mm	in	Dash Size	F1			
1203280	-0404	CR	04	6,0	1/4"	04	1/4-18	24,3	17,0	19,0
1216834	-0606	CR	06	10,0	3/8"	06	3/8-18	24,8	19,0	22,0
1202084	-0808	CR	08	13,0	1/2"	08	1/2-14	26,6	22,0	27,0
1216835	-1212	CR	12	19,0	3/4"	12	3/4-14	28,6	30,0	32,0
1216836	-1616	CR	16	25,0	1"	16	1-11 1/2	35,4	36,0	38,0

# // ORFS INSERTS

## // H1212410 ORFS Male

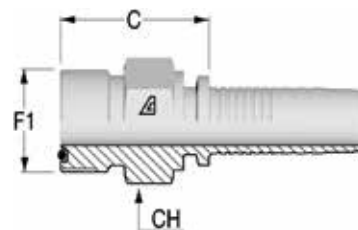

Item Code	Tale/Head	Nut Type	ID			F1	F1	C	CH
	Dash		Dash	mm	in	Dash Size		mm	mm
1202488	-0404	NA	04	6,0	1/4"	04	9/16-18	22,3	17,0
1202489	-0406	NA	04	6,0	1/4"	06	11/16-16	24,3	19,0
1214185	-0506	NA	05	8,0	5/16"	06	11/16-16	24,3	19,0
1202490	-0606	NA	06	10,0	3/8"	06	11/16-16	24,3	19,0
1202491	-0608	NA	06	10,0	3/8"	08	13/16-16	26,3	22,0
1202055	-0610	NA	06	10,0	3/8"	10	1-14	29,8	27,0
1202492	-0808	NA	08	13,0	1/2"	08	13/16-16	27,1	22,0
1202054	-0810	NA	08	13,0	1/2"	10	1-14	30,6	27,0
1202493	-0812	NA	08	13,0	1/2"	12	1 3/16-12	34,1	32,0
1202892	-1010	NA	10	16,0	5/8"	10	1-14	30,6	27,0
1202494	-1012	NA	10	16,0	5/8"	12	1 3/16-12	34,1	32,0
1202495	-1210	NA	12	19,0	3/4"	10	1-14	31,1	27,0
1202496	-1212	NA	12	19,0	3/4"	12	1 3/16-12	34,6	32,0
1202497	-1216	NA	12	19,0	3/4"	16	1 7/16-12	38,1	41,0
1202498	-1616	NA	16	25,0	1"	16	1 7/16-12	37,9	38,0
1202499	-1620	NA	16	25,0	1"	20	1 11/16-12	39,9	46,0
1202500	-2020	NA	20	32,0	1 1/4"	20	1 11/16-12	41,5	46,0

Dimensions shown may be changed without prior notice

**// H1222411**

**ORFS Female with Stem Hexagon**

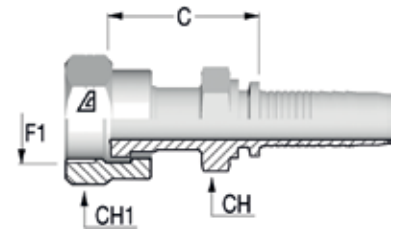

Item Code	Tale/Head Dash	Nut Type	ID		F1		F1	C	CH	CH1
			Dash	mm	in	Dash Size				
1203220	-0304	CR	03	5,0	3/16"	04	9/16-18	26,8	14,0	17,0
1201586	-0404	CR	04	6,0	1/4"	04	9/16-18	27,3	14,0	17,0
1201855	-0406	CR	04	6,0	1/4"	06	11/16-16	30,3	17,0	22,0
1203143	-0408	CR	04	6,0	1/4"	08	13/16-16	35,3	22,0	24,0
1201741	-0506	CR	05	8,0	5/16"	06	11/16-16	30,3	17,0	22,0
1203237	-0604	CR	06	10,0	3/8"	04	9/16-18	28,3	17,0	17,0
1202369	-0606	CR	06	10,0	3/8"	06	11/16-16	30,3	17,0	22,0
1201339	-0608	CR	06	10,0	3/8"	08	13/16-16	35,3	22,0	24,0
1202563	-0806	CR	08	13,0	1/2"	06	11/16-16	32,1	19,0	22,0
1201338	-0808	CR	08	13,0	1/2"	08	13/16-16	36,1	22,0	24,0
1202052	-0810	CR	08	13,0	1/2"	10	1-14	39,6	24,0	30,0
1203053	-0812	CR	08	13,0	1/2"	12	1 3/16-12	42,1	30,0	36,0
1203061	-1008	CR	10	16,0	5/8"	08	13/16-16	37,1	24,0	24,0
1202612	-1010	CR	10	16,0	5/8"	10	1-14	39,6	24,0	30,0
1201815	-1012	CR	10	16,0	5/8"	12	1 3/16-12	42,1	30,0	36,0
1201782	-1210	CR	12	19,0	3/4"	10	1-14	40,1	27,0	30,0
1202560	-1212	CR	12	19,0	3/4"	12	1 3/16-12	42,6	30,0	36,0
1202053	-1216	CR	12	19,0	3/4"	16	1 7/16-12	48,6	36,0	41,0
1216717	-1416	CR	14	22,0	7/8"	16	1 7/16-12	48,6	36,0	41,0
1203142	-1612	CR	16	25,0	1"	12	1 3/16-12	45,4	32,0	36,0
1201446	-1616	CR	16	25,0	1"	16	1 7/16-12	49,4	36,0	41,0
1203056	-1620	CR	16	25,0	1"	20	1 11/16-12	50,4	41,0	50,0
1201447	-2020	CR	20	32,0	1 1/4"	20	1 11/16-12	52,0	41,0	50,0
1226017	-2024	CR	20	32,0	1 1/4"	24	2-12	56,5	50,0	60,0
1202046	-2424	CR	24	38,0	1 1/2"	24	2-12	56,5	50,0	60,0



**// H1222443-M**

**45° ORFS Female - Medium Drop**

**DK ORFS 45M**

**Solid one piece**

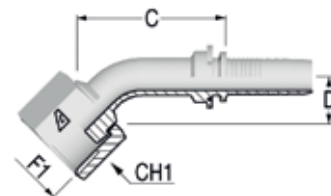

Item Code	Tale/Head Dash	Nut Type	ID		F1 Dash Size	F1	C	D Drop	CH1	
			Dash	mm						in
1202774	-0404	SN	04	6,0	1/4"	04	9/16-18	41,1	11,0	17,0
1202775	-0406	SN	04	6,0	1/4"	06	11/16-16	46,1	11,0	22,0
1202871	-0506	SN	05	8,0	5/16"	06	11/16-16	46,3	12,0	22,0
1202776	-0606	SN	06	10,0	3/8"	06	11/16-16	47,4	12,0	22,0
1202777	-0608	SN	06	10,0	3/8"	08	13/16-16	51,2	15,0	24,0
1202854	-0808	CR	08	13,0	1/2"	08	13/16-16	47,1	16,0	24,0
1202771	-0810	SN	08	13,0	1/2"	10	1-14	50,4	16,5	30,0
1202819	-1010	SN	10	16,0	5/8"	10	1-14	57,7	17,0	30,0
1202853	-1012	SN	10	16,0	5/8"	12	1 3/16-12	63,1	21,0	36,0
1203060	-1210	CR	12	19,0	3/4"	10	1-14	51,4	24,0	30,0
1202872	-1212	SN	12	19,0	3/4"	12	1 3/16-12	63,5	21,0	36,0
1202915	-1216	SN	12	19,0	3/4"	16	1 7/16-12	70,7	24,0	41,0
1202797	-1616	SN	16	25,0	1"	16	1 7/16-12	82,4	26,0	41,0
1203141	-1620	SN	16	25,0	1"	20	1 11/16-12	85,4	26,0	50,0
1202873	-2020	SN	20	32,0	1 1/4"	20	1 11/16-12	97,4	26,0	50,0
1203140	-2024	SN	20	32,0	1 1/4"	24	2-12	101,1	28,0	60,0
1202874	-2424	SN	24	38,0	1 1/2"	24	2-12	104,4	28,0	60,0

**// H1222493-S**

**90° ORFS Female - Short Drop**

**DK ORFS 90S**

**Solid one piece**

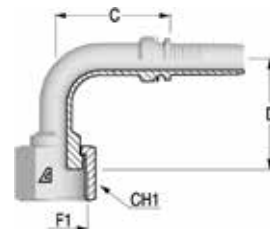

Item Code	Tale/Head Dash	Nut Type	ID		F1 Dash Size	F1	C	D Drop	CH1	
			Dash	mm						in
1202778	-0404	SN	04	6,0	1/4"	04	9/16-18	28,5	21,0	17,0
1202856	-0406	SN	04	6,0	1/4"	06	11/16-16	32,0	23,0	22,0
1202857	-0506	SN	05	8,0	5/16"	06	11/16-16	49,3	23,0	22,0
1202858	-0606	SN	06	10,0	3/8"	06	11/16-16	41,8	25,0	22,0
1202859	-0608	SN	06	10,0	3/8"	08	13/16-16	41,8	29,0	24,0
1203392	-0806	CR	08	13,0	1/2"	06	11/16-16	44,1	25,0	22,0
1202855	-0808	CR	08	13,0	1/2"	08	13/16-16	39,8	29,0	24,0
1203054	-0810	SN	08	13,0	1/2"	10	1-14	46,3	32,5	30,0
1203334	-0812	SN	08	13,0	1/2"	12	1 3/16-12	56,3	51,0	36,0
1202860	-1010	SN	10	16,0	5/8"	10	1-14	52,3	32,5	30,0
1202861	-1012	SN	10	16,0	5/8"	12	1 3/16-12	55,4	49,0	36,0
1202862	-1212	SN	12	19,0	3/4"	12	1 3/16-12	60,6	51,0	36,0
1203055	-1216	SN	12	19,0	3/4"	16	1 7/16-12	61,6	56,0	41,0
1203209	-1612	CR	16	25,0	1"	12	1 3/16-12	54,6	51,0	36,0
1202863	-1616	SN	16	25,0	1"	16	1 7/16-12	80,0	58,0	41,0
1203135	-1620	SN	16	25,0	1"	20	1 11/16-12	82,6	64,0	50,0
1203133	-2020	SN	20	32,0	1 1/4"	20	1 11/16-12	95,0	68,0	50,0
1214211	-2024	SN	20	32,0	1 1/4"	24	2-12	102,0	69,0	60,0
1214213	-2424	SN	24	38,0	1 1/2"	24	2-12	103,7	78,0	60,0

Dimensions shown may be changed without prior notice

**// H1222493-M**

**90° ORFS Female - Medium Drop**  
**DK ORFS 90M**  
**Solid one piece**

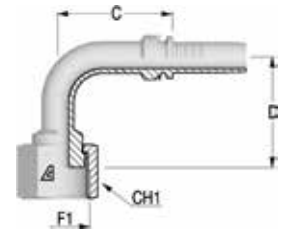

Item Code	Tale/Head Dash	Nut Type	ID			F1		F1	C	D Drop	CH1
			Dash	mm	in	Dash Size	mm				
1202875	-0404	SN	04	6,0	1/4"	04	9/16-18	29,8	32,0	17,0	
1202715	-0406	SN	04	6,0	1/4"	06	11/16-16	37,3	38,0	22,0	
1202779	-0506	SN	05	8,0	5/16"	06	11/16-16	40,7	34,0	22,0	
1202780	-0606	SN	06	10,0	3/8"	06	11/16-16	41,8	38,0	22,0	
1202716	-0608	SN	06	10,0	3/8"	08	13/16-16	43,8	41,0	24,0	
1202781	-0808	CR	08	13,0	1/2"	08	13/16-16	34,8	42,0	24,0	
1202770	-0810	SN	08	13,0	1/2"	10	1-14	48,3	47,0	30,0	
1202782	-1010	SN	10	16,0	5/8"	10	1-14	55,4	44,0	30,0	
1203137	-1012	SN	10	16,0	5/8"	12	1 3/16-12	55,4	58,0	36,0	
1202783	-1212	SN	12	19,0	3/4"	12	1 3/16-12	61,6	58,0	36,0	
1202916	-1216	SN	12	19,0	3/4"	16	1 7/16-12	65,6	71,0	41,0	
1216748	-1612	CR	16	25,0	1"	12	1 3/16-12	62,6	58,0	36,0	
1202717	-1616	SN	16	25,0	1"	16	1 7/16-12	82,6	66,0	41,0	
1203069	-1620	SN	16	25,0	1"	20	1 11/16-12	82,6	78,0	50,0	
1202876	-2020	SN	20	32,0	1 1/4"	20	1 11/16-12	97,0	78,0	50,0	
1203132	-2024	SN	20	32,0	1 1/4"	24	2-12	102,0	84,0	60,0	
1202877	-2424	SN	24	38,0	1 1/2"	24	2-12	107,8	87,0	60,0	

**// H1222493-L**

**90° ORFS Female - Long Drop**  
**DK ORFS 90L**  
**Solid one piece**

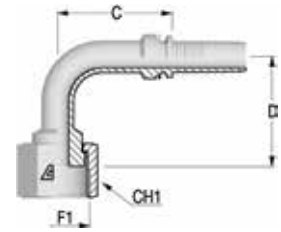

Item Code	Tale/Head Dash	Nut Type	ID			F1		F1	C	D Drop	CH1
			Dash	mm	in	Dash Size	mm				
1210841	-0404	SN	04	6,0	1/4"	04	9/16-18	32,8	46,0	17,0	
1203139	-0406	SN	04	6,0	1/4"	06	11/16-16	34,8	54,0	22,0	
1203138	-0606	SN	06	10,0	3/8"	06	11/16-16	41,8	54,0	22,0	
1203057	-0608	SN	06	10,0	3/8"	08	13/16-16	46,8	64,0	24,0	
1202922	-0808	CR	08	13,0	1/2"	08	13/16-16	38,3	64,0	24,0	
1214208	-0810	SN	08	13,0	1/2"	10	1-14	46,3	70,0	30,0	
1202918	-1010	SN	10	16,0	5/8"	10	1-14	55,4	70,0	30,0	
1202919	-1012	SN	10	16,0	5/8"	12	1 3/16-12	55,4	96,0	36,0	
1202920	-1212	SN	12	19,0	3/4"	12	1 3/16-12	61,6	96,0	36,0	
1202921	-1216	SN	12	19,0	3/4"	16	1 7/16-12	61,6	118,0	41,0	
1203136	-1616	SN	16	25,0	1"	16	1 7/16-12	82,6	114,0	41,0	
1203134	-2020	SN	20	32,0	1 1/4"	20	1 11/16-12	97,0	129,0	50,0	
1214210	-2024	SN	20	32,0	1 1/4"	24	2-12	102,0	141,0	60,0	
1214212	-2424	SN	24	38,0	1 1/2"	24	2-12	110,8	141,0	60,0	

## // FRENCH INSERTS

### // H1211810

**Metric Male  
French Type**

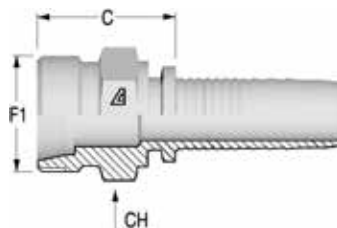

Item Code	Tale/Head Dash/mm	Nut Type	ID			F1	OD1	C	CH
			Dash	mm	in				
1200522	-0520	NA	05	8,0	5/16"	M20X1.5	13,25	17,0	22,0
1200317	-0620	NA	06	10,0	3/8"	M20X1.5	13,25	25,3	22,0
1200361	-0824	NA	08	13,0	1/2"	M24X1.5	16,75	27,1	24,0
1200404	-1030	NA	10	16,0	5/8"	M30X1.5	21,25	31,1	30,0
1200435	-1236	NA	12	19,0	3/4"	M36X1.5	26,75	33,6	36,0

### // H1221813

**Metric Female  
French Type**

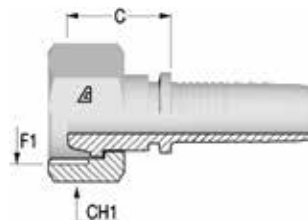

Item Code	Tale/Head Dash/mm	Nut Type	ID			F1	OD1	C	CH1
			Dash	mm	in				
1200651	-0520	SN	05	8,0	5/16"	M20X1.5	14	23,8	24,0
1200681	-0620	SN	06	10,0	3/8"	M20X1.5	14	23,8	24,0
1200717	-0824	SN	08	13,0	1/2"	M24X1.5	16	26,8	30,0
1200744	-1030	SN	10	16,0	5/8"	M30X1.5	22	26,6	36,0
1200770	-1236	SN	12	19,0	3/4"	M36X1.5	28	27,0	42,0

### // H1221893

**90° Metric Female  
French type**

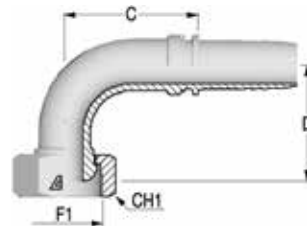

Item Code	Tale/Head Dash/mm	Nut Type	ID			F1	OD1	C	D Drop	CH1
			Dash	mm	in					
1200654	-0520	SN	05	8,0	5/16"	M20X1.5	14	32,5	36,5	24,0
1200683	-0620	SN	06	10,0	3/8"	M20X1.5	14	36,7	44,0	24,0
1200719	-0824	SN	08	13,0	1/2"	M24X1.5	16	39,5	46,0	30,0
1203156	-1030	SN	10	16,0	5/8"	M30X1.5	22	43,0	49,0	36,0
1200773	-1236	SN	12	19,0	3/4"	M36X1.5	28	46,6	48,5	42,0

Dimensions shown may be changed without prior notice

## // JIS INSERTS

### // H1223711

#### JIS Female 60° Cone - B 8363 (type C)

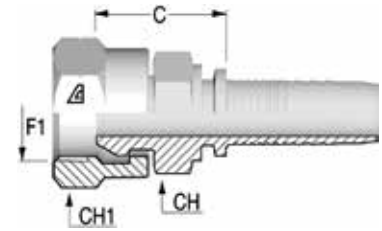

Item Code	Tale/Head Dash	Nut Type	ID			F1		F1	C	CH	CH1
			Dash	mm	in	Dash Size	mm				
1203110	-0404	CR	04	6,0	1/4"	04	1/4-19	24,3	17,0	19,0	
1226067	-0406	CR	04	6,0	1/4"	06	3/8-19	25,5	19,0	22,0	
1203109	-0606	CR	06	10,0	3/8"	06	3/8-19	25,5	19,0	22,0	
1226068	-0608	CR	06	10,0	3/8"	08	1/2-14	25,3	22,0	27,0	
1203108	-0808	CR	08	13,0	1/2"	08	1/2-14	26,1	22,0	27,0	
1226069	-1008	CR	10	16,0	5/8"	08	1/2-14	27,1	24,0	27,0	
1226549	-1012	CR	10	16,0	5/8"	12	3/4-14	29,6	30,0	36,0	
1203107	-1212	CR	12	19,0	3/4"	12	3/4-14	30,1	30,0	36,0	
1214218	-1616	CR	16	25,0	1"	16	1-11	34,9	36,0	41,0	

### // H1223741

#### 45° JIS Female 60° Cone - B 8363 (type C)

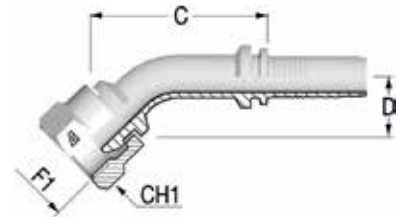

Item Code	Tale/Head Dash	Nut Type	ID			F1		C	D Drop	CH1
			Dash	mm	in	Dash Size	mm			
1216798	-0404	CR	04	6,0	1/4"	04	1/4-19	24,3	19,0	19,0
1216799	-0606	CR	06	10,0	3/8"	06	3/8-19	26,5	21,0	22,0
1216800	-0808	CR	08	13,0	1/2"	08	1/2-14	27,0	22,0	27,0
1216801	-1212	CR	12	19,0	3/4"	12	3/4-14	19,9	25,0	36,0

### // H1223791

#### 90° JIS Female 60° Cone - B 8363 (type C)

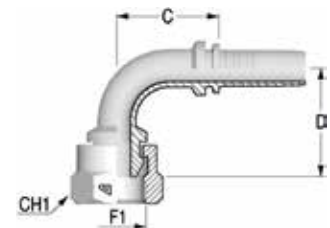

Item Code	Tale/Head Dash	Nut Type	ID			F1		C	D Drop	CH1
			Dash	mm	in	Dash Size	mm			
1216803	-0404	CR	04	6,0	1/4"	04	1/4-19	25,3	33,0	19,0
1216805	-0606	CR	06	10,0	3/8"	06	3/8-19	32,3	36,5	22,0
1216806	-0808	CR	08	13,0	1/2"	08	1/2-14	37,3	38,5	27,0
1216807	-1212	CR	12	19,0	3/4"	12	3/4-14	51,6	52,0	36,0

**// H122381Z**

**JIS Female 60° Seat Flare - B 8363 (type F)**

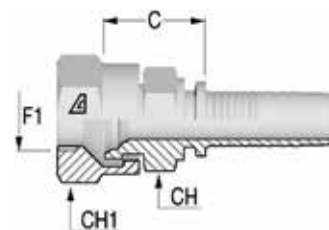

Item Code	Tale/Head Dash	Nut Type	ID			F1		F1	C	CH	CH1
			Dash	mm	in	Dash Size	Dash Size				
1202947	-0404	CR	04	6,0	1/4"	04	1/4-19	20,8	17,0	19,0	
1202879	-0606	CR	06	10,0	3/8"	06	3/8-19	21,8	19,0	22,0	
1202878	-0808	CR	08	13,0	1/2"	08	1/2-14	23,6	22,0	27,0	
1203106	-1212	CR	12	19,0	3/4"	12	3/4-14	27,1	30,0	36,0	
1203105	-1616	CR	16	25,0	1"	16	1-11	32,9	36,0	41,0	
1201585	-2020	TN	20	32,0	1 1/4"	20	1 1/4-11	39,5	46,0	50,0	
1201677	-2424	TN	24	38,0	1 1/2"	24	1 1/2-11	41,5	50,0	55,0	

**// H122384Z**

**45° JIS Female 60° Seat Flare - B 8363 (type F)**

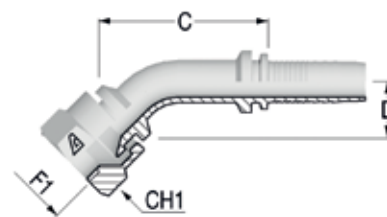

Item Code	Tale/Head Dash	Nut Type	ID			F1		C	D Drop	CH1
			Dash	mm	in	Dash Size	Dash Size			
1203104	-0404	CR	04	6,0	1/4"	04	1/4-19	42,5	15,0	19,0
1203103	-0606	CR	06	10,0	3/8"	06	3/8-19	50,6	16,5	22,0
1203101	-1212	CR	12	19,0	3/4"	12	3/4-14	72,5	22,0	36,0
1203100	-1616	CR	16	25,0	1"	16	1-11	82,0	29,0	41,0

**// H122389Z**

**90° JIS Female 60° Seat Flare - B 8363 (type F)**

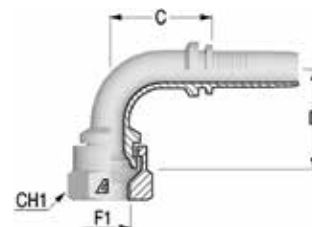

Item Code	Tale/Head Dash	Nut Type	ID			F1		C	D Drop	CH1
			Dash	mm	in	Dash Size	Dash Size			
1203095	-0404	CR	04	6,0	1/4"	04	1/4-19	27,3	29,5	19,0
1203094	-0606	CR	06	10,0	3/8"	06	3/8-19	31,3	33,0	22,0
1203093	-0808	CR	08	13,0	1/2"	08	1/2-14	37,3	36,5	27,0
1203092	-1212	CR	12	19,0	3/4"	12	3/4-14	46,1	52,0	36,0
1203091	-1616	CR	16	25,0	1"	16	1-11	77,1	64,5	41,0

Dimensions shown may be changed without prior notice

## // KOMATSU INSERTS

### // H1224011

#### Komatsu Female

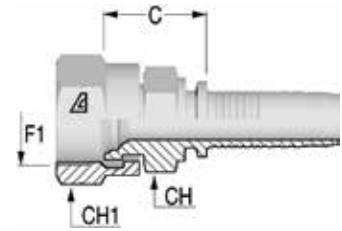

Item Code	Tale/Head Dash	Nut Type	ID			F1		F1	C	CH	CH1
			Dash	mm	in	Dash Size	mm				
1200502	-0414	CR	04	6,0	1/4"	14	M14X1.5	20,8	17,0	19,0	
1216808	-0614	CR	06	10,0	3/8"	14	M14X1.5	20,8	17,0	19,0	
1200334	-0618	CR	06	10,0	3/8"	18	M18X1.5	21,8	19,0	22,0	
1202688	-0822	CR	08	13,0	1/2"	22	M22X1.5	23,6	22,0	27,0	
1200414	-1024	CR	10	16,0	5/8"	24	M24X1.5	27,1	30,0	32,0	
1200444	-1230	CR	12	19,0	3/4"	30	M30X1.5	27,6	30,0	36,0	
1201720	-1633	CR	16	25,0	1"	33	M33X1.5	35,7	36,0	41,0	
1202032	-2442	CR	24	38,0	1 1/2"	42	M42X1.5	44,0	55,0	55,0	

### // H1244110

#### Komatsu Flange

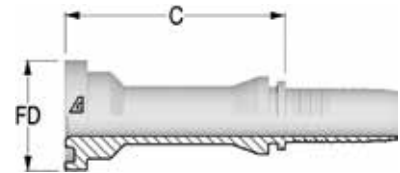

Item Code	Tale/Head Dash	Dash	ID		Flange		C	FD	WP
			mm	in	Dash Size	Flange Size			
1201625	-1010	10	16,0	5/8"	10	5/8	46,7	34,0	-

**// H1244140**

**45° Komatsu Flange**  
**Solid one piece**

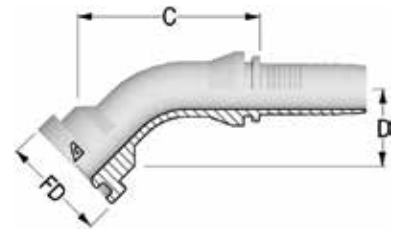

Item Code	Tale/Head	Dash	ID		Flange	Flange Size	FD	C	D Drop	WP
	Dash		mm	in	Dash Size					
1202066	-1010	10	16,0	5/8"	10	-	34,0	49,1	25,0	-

**// H1244190**

**90° Komatsu Flange**  
**Solid one piece**

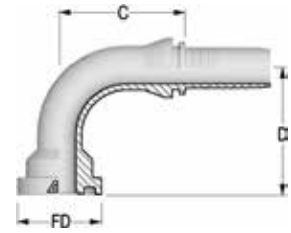

Item Code	Tale/Head	Dash	ID		Flange	Flange Size	FD	C	D Drop	WP
	Dash		mm	in	Dash Size					
1202067	-1010	10	16,0	5/8"	10	-	34,0	51,0	51,0	-

Dimensions shown may be changed without prior notice

## // SAE FLANGES

### // H1243310

Flange SAE 3000 PSI J518 Code 61 - SFL

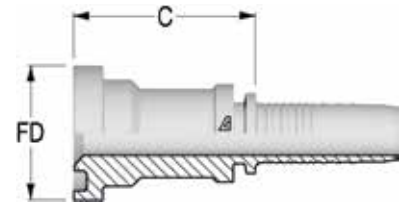

Item Code	Tale/Head	ID		Flange		Flange Size	C	FD	WP
	Dash	Dash	mm	in	Dash Size				
1202747	-0808	08	13,0	1/2"	08	1/2	41,0	30,2	5000
1202763	-0812	08	13,0	1/2"	12	3/4	42,0	38,1	5000
1202801	-1012	10	16,0	5/8"	12	3/4	42,2	38,1	5000
1201734	-1212	12	19,0	3/4"	12	3/4	42,5	38,1	5000
1202750	-1216	12	19,0	3/4"	16	1	50,5	44,5	5000
1201408	-1616	16	25,0	1"	16	1	51,4	44,5	5000
1201409	-1620	16	25,0	1"	20	1 1/4	53,9	50,8	4000
1216849	-1624	16	25,0	1"	24	1 1/2	56,9	60,3	3000
1221654	-2016	20	32,0	1 1/4"	16	1	53,0	44,5	5000
1201410	-2020	20	32,0	1 1/4"	20	1 1/4	55,5	50,8	4000
1201411	-2024	20	32,0	1 1/4"	24	1 1/2	58,5	60,3	3000
1201412	-2424	24	38,0	1 1/2"	24	1 1/2	58,5	60,3	3000
1201413	-2432	24	38,0	1 1/2"	32	2	70,0	71,4	3000
1221662	-3224	32	51,0	2"	24	1 1/2	66,0	60,3	3000
1201414	-3232	32	51,0	2"	32	2	70,0	71,4	3000
1202074	-3240	32	51,0	2"	40	2 1/2	83,0	81,1	2500
1226113	-4032	40	63,0	2 1/2"	32	2	86,5	71,4	3000
1203063	-4040	40	63,0	2 1/2"	40	2 1/2	86,5	84,1	2500

### // H1243320

22° Flange SAE 3000 PSI J518 Code 61 - SFL 22  
Solid one piece

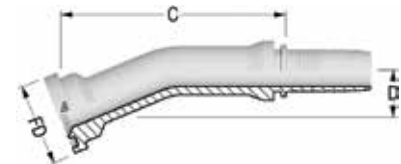

Item Code	Tale/Head	ID		Flange		Flange Size	FD	C	D Drop	WP
	Dash	Dash	mm	in	Dash Size					
1216854	-1616	16	25,0	1"	16	1	44,5	92,7	12,0	5000
1216856	-2020	20	32,0	1 1/4"	20	1 1/4	50,8	113,6	16,0	4000
1216857	-2024	20	32,0	1 1/4"	24	1 1/2	60,3	114,7	20,5	3000
1216858	-2424	24	38,0	1 1/2"	24	1 1/2	60,3	131,0	22,0	3000
1216859	-3232	32	51,0	2"	32	2	71,4	153,0	30,0	3000



**// H1243330**

**30° Flange SAE 3000 PSI J518 Code 61 - SFL 30**  
**Solid one piece**

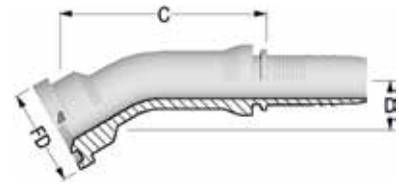

Item Code	Tale/Head		ID		Flange		FD	C	D Drop	WP
	Dash	Dash	mm	in	Dash Size	Flange Size				
1216861	-1212	12	19,0	3/4"	12	3/4	38,1	80,8	12,0	5000
1216862	-1216	12	19,0	3/4"	16	1	44,5	83,8	12,0	5000
1216863	-1616	16	25,0	1"	16	1	44,5	89,8	12,0	5000
1216864	-1620	16	25,0	1"	20	1 1/4	50,8	90,0	12,0	4000
1216865	-1624	16	25,0	1"	24	1 1/2	60,3	104,8	12,0	3000
1216866	-2020	20	32,0	1 1/4"	20	1 1/4	50,8	102,4	12,0	4000
1216867	-2024	20	32,0	1 1/4"	24	1 1/2	60,3	111,9	13,0	3000
1216868	-2424	24	38,0	1 1/2"	24	1 1/2	60,3	128,6	23,0	3000
1216869	-2432	24	38,0	1 1/2"	32	2	71,4	147,0	29,5	3000

**// H1243340**

**45° Flange SAE 3000 PSI J518 Code 61 - SFL 45**  
**Solid one piece**

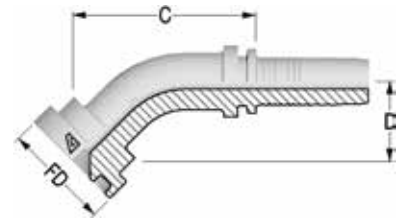

Item Code	Tale/Head		ID		Flange		FD	C	D Drop	WP
	Dash	Dash	mm	in	Dash Size	Flange Size				
1202748	-0808	08	13,0	1/2"	08	1/2	30,2	52,9	22,0	5000
1202751	-0812	08	13,0	1/2"	12	3/4	38,1	60,3	26,0	5000
1202804	-1012	10	16,0	5/8"	12	3/4	38,1	65,0	26,0	5000
1202678	-1212	12	19,0	3/4"	12	3/4	38,1	73,7	32,0	5000
1202752	-1216	12	19,0	3/4"	16	1	44,5	77,9	29,0	5000
1214223	-1220	12	19,0	3/4"	20	1 1/4	50,8	81,5	30,0	5000
1202681	-1616	16	25,0	1"	16	1	44,5	82,7	33,5	5000
1201845	-1620	16	25,0	1"	20	1 1/4	50,8	82,2	36,0	4000
1216872	-2016	20	32,0	1 1/4"	16	1	44,5	114,6	35,1	5000
1201848	-2020	20	32,0	1 1/4"	20	1 1/4	50,8	95,1	37,5	4000
1202677	-2024	20	32,0	1 1/4"	24	1 1/2	60,3	104,1	40,0	3000
1216873	-2420	24	38,0	1 1/2"	20	1 1/4	50,8	144,9	49,5	4000
1202753	-2424	24	38,0	1 1/2"	24	1 1/2	60,3	116,7	48,0	3000
1202754	-2432	24	38,0	1 1/2"	32	2	71,4	135,6	55,5	3000
1201982	-3232	32	51,0	2"	32	2	71,4	140,8	47,5	3000
1216874	-4040	40	63,0	2 1/2"	40	2 1/2	84,1	139,0	53,0	2500

Dimensions shown may be changed without prior notice

**// H1243360**

**60° Flange SAE 3000 PSI J518 Code 61 - SFL 60**  
**Solid one piece**

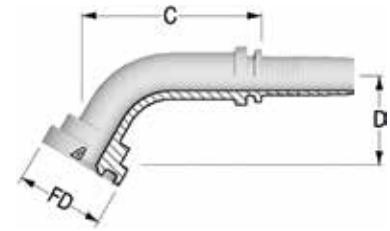

Item Code	Tale/Head		ID		Flange		Flange Size	FD	C	D Drop	WP
	Dash	Dash	mm	in	Dash Size	Dash Size					
1216877	-0808	08	13,0	1/2"	08	1/2	30,2	62,8	30,0	5000	
1216878	-1212	12	19,0	3/4"	12	3/4	38,1	85,7	37,0	5000	
1216879	-1216	12	19,0	3/4"	16	1	44,5	102,0	44,0	5000	
1216880	-1616	16	25,0	1"	16	1	44,5	101,0	47,0	5000	
1216881	-1620	16	25,0	1"	20	1 1/4	50,8	106,6	43,5	4000	
1216882	-2020	20	32,0	1 1/4"	20	1 1/4	50,8	129,5	56,5	4000	
1202882	-2424	24	38,0	1 1/2"	24	1 1/2	60,3	151,5	57,0	3000	
1216884	-3232	32	51,0	2"	32	2	71,4	173,0	92,0	3000	

**// H1243390**

**90° Flange SAE 3000 PSI J518 Code 61 - SFL 90**  
**Solid one piece**

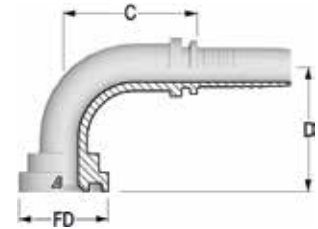

Item Code	Tale/Head		ID		Flange		Flange Size	FD	C	D Drop	WP
	Dash	Dash	mm	in	Dash Size	Dash Size					
1202749	-0808	08	13,0	1/2"	08	1/2	30,2	45,8	42,0	5000	
1202755	-0812	08	13,0	1/2"	12	3/4	38,1	45,3	51,0	5000	
1216886	-0816	08	13,0	1/2"	16	1	44,5	59,9	63,0	5000	
1202805	-1012	10	16,0	5/8"	12	3/4	38,1	49,4	51,0	5000	
1202679	-1212	12	19,0	3/4"	12	3/4	38,1	59,7	58,0	5000	
1202756	-1216	12	19,0	3/4"	16	1	44,5	66,2	64,5	5000	
1202883	-1220	12	19,0	3/4"	20	1 1/4	50,8	69,7	60,0	4000	
1202680	-1616	16	25,0	1"	16	1	44,5	70,6	67,0	5000	
1201846	-1620	16	25,0	1"	20	1 1/4	50,8	73,6	71,0	4000	
1216894	-1624	16	25,0	1"	24	1 1/2	60,3	93,1	75,0	3000	
1202884	-2016	20	32,0	1 1/4"	16	1	44,5	94,4	65,0	5000	
1201847	-2020	20	32,0	1 1/4"	20	1 1/4	50,8	88,0	84,0	4000	
1202676	-2024	20	32,0	1 1/4"	24	1 1/2	60,3	91,5	87,5	3000	
1202806	-2420	24	38,0	1 1/2"	20	1 1/4	50,8	93,6	93,0	4000	
1202757	-2424	24	38,0	1 1/2"	24	1 1/2	60,3	104,8	91,0	3000	
1202758	-2432	24	38,0	1 1/2"	32	2	71,4	104,8	115,0	3000	
1216898	-3224	32	51,0	2"	24	1 1/2	60,3	132,8	133,0	3000	
1201983	-3232	32	51,0	2"	32	2	71,4	129,3	130,0	3000	
1203169	-3240	32	51,0	2"	40	2 1/2	84,1	103,0	100,0	2500	
1216900	-4032	40	63,0	2 1/2"	32	2	71,4	106,2	160,0	3000	
1203364	-4040	40	63,0	2 1/2"	40	2 1/2	84,1	137,2	125,0	2500	

**// H1243610**

**Flange SAE 6000 PSI J518 Code 62 - SFS**

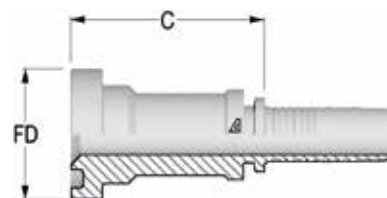

Item Code	Tale/Head	ID	Flange		C	FD	WP		
	Dash		Dash	Dash Size				Flange Size	
	Dash	mm	in	Dash Size	mm	mm	psi		
1202511	-0808	08	13,0	1/2"	08	1/2	47,0	31,8	6000
1202759	-0812	08	13,0	1/2"	12	3/4	52,0	41,3	6000
1202807	-1012	10	16,0	5/8"	12	3/4	52,2	41,3	6000
1226137	-1016	10	16,0	5/8"	16	1	55,7	47,6	6000
1202733	-1212	12	19,0	3/4"	12	3/4	52,5	41,3	6000
1202760	-1216	12	19,0	3/4"	16	1	55,5	47,6	6000
1216908	-1612	16	25,0	1"	12	3/4	56,4	41,3	6000
1201415	-1616	16	25,0	1"	16	1	56,4	47,6	6000
1201416	-1620	16	25,0	1"	20	1 1/4	63,4	54,0	6000
1201417	-2020	20	32,0	1 1/4"	20	1 1/4	83,0	54,0	6000
1201418	-2024	20	32,0	1 1/4"	24	1 1/2	71,0	63,5	6000
1216909	-2420	24	38,0	1 1/2"	20	1 1/4	95,0	54,0	6000
1201419	-2424	24	38,0	1 1/2"	24	1 1/2	101,0	63,5	6000
1201420	-2432	24	38,0	1 1/2"	32	2	76,0	79,4	6000
1201421	-3232	32	51,0	2"	32	2	76,0	79,4	6000

**// H1243640**

**45° Flange SAE 6000 PSI J518 Code 62 - SFS 45  
Solid one piece**

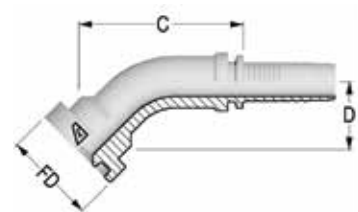

Item Code	Tale/Head	ID	Flange		FD	C	D Drop	WP		
	Dash		Dash	Dash Size					Flange Size	
	Dash	mm	in	Dash Size	mm	mm	mm	psi		
1201729	-0808	08	13,0	1/2"	08	1/2	31,8	56,5	23,0	6000
1202764	-0812	08	13,0	1/2"	12	3/4	41,3	79,9	30,5	6000
1216910	-1012	10	16,0	5/8"	12	3/4	41,3	69,0	31,0	6000
1202082	-1212	12	19,0	3/4"	12	3/4	41,3	84,1	31,0	6000
1202083	-1216	12	19,0	3/4"	16	1	47,6	80,0	33,5	6000
1201794	-1616	16	25,0	1"	16	1	47,6	96,7	36,0	6000
1202091	-1620	16	25,0	1"	20	1 1/4	54,0	96,1	39,0	6000
1216911	-2016	20	32,0	1 1/4"	16	1	47,6	114,0	35,0	6000
1202761	-2020	20	32,0	1 1/4"	20	1 1/4	54,0	108,6	40,0	6000
1202452	-2024	20	32,0	1 1/4"	24	1 1/2	63,5	114,8	45,5	6000
1202453	-2424	24	38,0	1 1/2"	24	1 1/2	63,5	122,9	45,0	6000
1202765	-2432	24	38,0	1 1/2"	32	2	79,4	133,3	57,5	6000
1202734	-3232	32	51,0	2"	32	2	79,4	156,6	60,0	6000

Dimensions shown may be changed without prior notice

**// H1243690**

**90° Flange SAE 6000 PSI J518 Code 62 - SFS 90**  
**Solid one piece**

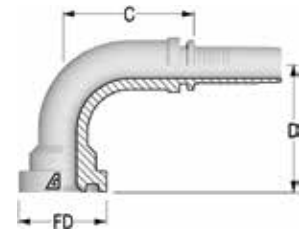

Item Code	Tale/Head		ID		Flange		Flange Size	FD	C	D Drop	WP
	Dash	Dash	mm	in	Dash Size	Dash Size					
1202257	-0808	08	13,0	1/2"	08	1/2	31,8	47,8	46,0	6000	
1202766	-0812	08	13,0	1/2"	12	3/4	41,3	47,8	54,0	6000	
1242230	-1008	10	16,0	5/8"	08	1/2	31,8	50,0	52,0	6000	
1202808	-1008	10	16,0	5/8"	08	1/2	31,8	50,0	52,0	6000	
1202814	-1012	10	16,0	5/8"	12	3/4	41,3	49,9	55,0	6000	
1202075	-1212	12	19,0	3/4"	12	3/4	41,3	63,2	61,0	6000	
1201795	-1216	12	19,0	3/4"	16	1	47,6	63,2	66,0	6000	
1216913	-1612	16	25,0	1"	12	3/4	41,3	72,6	61,0	6000	
1201739	-1616	16	25,0	1"	16	1	47,6	73,6	75,0	6000	
1202767	-1620	16	25,0	1"	20	1 1/4	54,0	77,6	78,0	6000	
1202735	-2020	20	32,0	1 1/4"	20	1 1/4	54,0	94,5	89,0	6000	
1202768	-2024	20	32,0	1 1/4"	24	1 1/2	63,5	98,0	94,0	6000	
1202736	-2424	24	38,0	1 1/2"	24	1 1/2	63,5	99,6	105,0	6000	
1202769	-2432	24	38,0	1 1/2"	32	2	79,4	116,9	123,0	6000	
1202762	-3232	32	51,0	2"	32	2	79,4	143,3	132,0	6000	

**// H10W3320**

**Split Flange Clamp 3000 PSI J518 Code 61 - FHL**

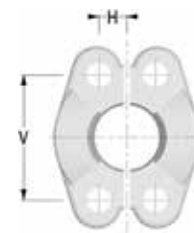

Item Code	ID	FD	V	H
	Dash	in	mm	mm
1900451	-0800	1/2"	38,1	8,7
1900457	-1200	3/4"	47,6	11,1
1900452	-1600	1"	52,4	13,1
1900454	-2000	1 1/4"	58,7	15,1
1900453	-2400	1 1/2"	69,9	17,9
1900455	-3200	2"	77,8	21,4
1900456	-4000	2 1/2"	89,0	25,5
1900458	-4800	3"	106,0	31,0
1901123	-5600	3 1/2"	120,0	35,0
1900715	-6400	4"	130,0	39,0

**// H10W3620**

**Split Flange Clamp 6000 PSI J518 Code 62 - FHS**

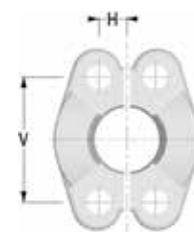

Item Code	ID	FD	V	H
	Dash	in	mm	mm
1900445	-0800	1/2"	40,5	9,1
1900450	-1200	3/4"	50,8	11,9
1900446	-1600	1"	57,2	13,9
1900448	-2000	1 1/4"	66,7	15,9
1900447	-2400	1 1/2"	79,4	18,3
1900449	-3200	2"	96,8	22,2

Dimensions shown may be changed without prior notice

**// H10W3310**

**4 Hole Flange Clamp 3000 PSI J518 Code 61 - VHL**

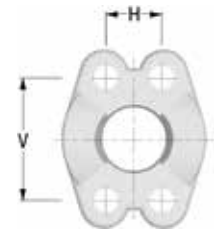

Item Code	ID	FD	V	H
	Dash	in	mm	mm
1900442	-1200	3/4"	47,6	22,2
1900437	-1600	1"	52,4	26,2
1900439	-2000	1 1/4"	58,7	30,2
1900438	-2400	1 1/2"	69,9	35,8
1900440	-3200	2"	77,8	42,8

**// H10W3610**

**4 Hole Flange Clamp 6000 PSI J518 Code 62 - VHS**

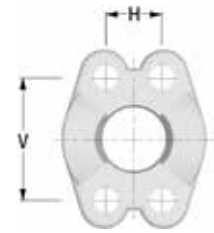

Item Code	ID	FD	V	H
	Dash	in	mm	mm
1900428	-0800	1/2"	40,5	18,2
1900433	-1200	3/4"	50,8	23,8
1900429	-1600	1"	57,2	27,8
1900431	-2000	1 1/4"	66,7	31,8
1900430	-2400	1 1/2"	79,4	36,6
1900432	-3200	2"	96,8	44,4
1900910	-4000	2 1/2"	123,8	58,7



## // MULTISPIRAL

// FERRULES.....	103	// NPTF INSERTS .....	110
// BSP INSERTS .....	104	// ORFS INSERTS .....	111
// DIN METRIC INSERTS .....	106	// SAE FLANGES .....	113
// JIC 37° INSERTS.....	108	// SUPERCAT FLANGES .....	116

Dimensions shown may be changed without prior notice

## // FERRULES

### // H1300SK4 Multispiral Ferrule

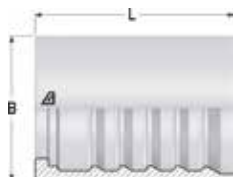

Item Code	ID		OD		L
	Dash	mm	in	mm	mm
1240185	12	19,0	3/4"	38,0	59,0
1240186	16	25,0	1"	46,0	64,0
1240187	20	31,0	1 1/4"	56,0	91,0
1240188	24	38,0	1 1/2"	62,0	91,0
1240189	32	51,0	2"	78,0	115,0

### // H1300NS4 Multispiral Ferrule

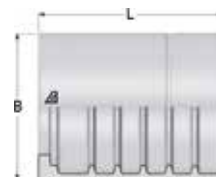

Item Code	ID		OD		L
	Dash	mm	in	mm	mm
1236599	12	19,0	3/4"	44,0	55,0
1236600	16	25,0	1"	51,0	64,0
1236601	20	31,0	1 1/4"	61,0	99,0
1236602	24	38,0	1 1/2"	70,0	89,5
1236603	32	51,0	2"	87,0	125,0

### // H1300NS6 Multispiral Ferrule



Item Code	ID		OD		L
	Dash	mm	in	mm	mm
1236604	20	31,0	1 1/4"	65,0	99,0
1236605	24	38,0	1 1/2"	73,0	89,5



## // BSP INSERTS

### // H1310510

**BSP Male 60° Flare  
AGR**

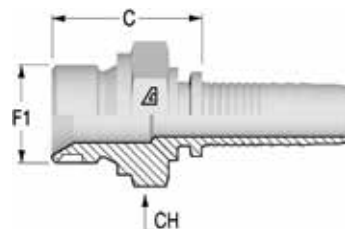

Item Code	Tale/Head	Nut Type	ID			F1	F1	C	CH
	Dash		Dash	mm	in	Dash Size	F1	mm	mm
1238090	-1212	NA	12	19,0	3/4"	12	3/4-14	37,5	32,0
1226162	-1616	NA	16	25,0	1"	16	1-11	44,5	41,0
1230555	-2020	NA	20	32,0	1 1/4"	20	1 1/4-11	95,5	50,0
1241600	-2424	NA	24	38,0	1 1/2"	24	1 1/2-11	56,0	55,0
1241601	-3232	NA	32	51,0	2"	32	2-11	71,5	70,0

### // H1320812

**BSP Female 60° Cone with O-Ring  
DKOR**

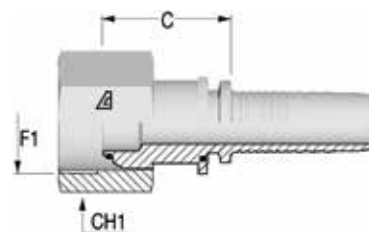

Item Code	Tale/Head	Nut Type	ID			F1	F1	C	CH1
	Dash		Dash	mm	in	Dash Size	F1	mm	mm
1226178	-1212	TN	12	19,0	3/4"	12	3/4-14	25,2	32,0
1241616	-1216	TN	12	19,0	3/4"	16	1-11	27,7	38,0
1226179	-1616	TN	16	25,0	1"	16	1-11	31,0	38,0
1241617	-1620	TN	16	25,0	1"	20	1 1/4-11	32,0	50,0
1238241	-2020	TN	20	32,0	1 1/4"	20	1 1/4-11	35,0	50,0
1239857	-2424	TN	24	38,0	1 1/2"	24	1 1/2-11	38,8	55,0
1238240	-3232	TN	20	32,0	1 1/4"	32	2-11	49,0	70,0

Dimensions shown may be changed without prior notice

**// H1320842**

**45° BSPP Female 60° Cone with O-Ring  
DKOR 45  
Solid one piece**

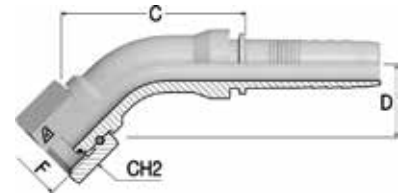

Item Code	Tale/Head Dash	Nut Type	ID			F1		F1	C	D Drop	CH1
			Dash	mm	in	Dash Size	mm				
1241628	-1212	TN	12	19,0	3/4"	12	3/4-14	75,2	30,0	32,0	
1237423	-1616	TN	16	25,0	1"	16	1-11	92,1	40,0	38,0	
1241629	-2020	TN	20	32,0	1 1/4"	20	1 1/4-11	90,4	40,0	50,0	
1242138	-2424	TN	24	38,0	1 1/2"	24	1 1/2-11	113,0	46,0	55,0	
1241630	-3232	TN	32	51,0	2"	32	2-11	153,5	60,0	70,0	

**// H1320892**

**90° BSPP Female 60° Cone with O-Ring  
DKOR 90  
Solid one piece**

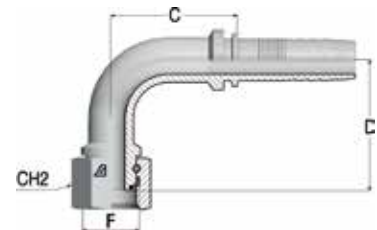

Item Code	Tale/Head Dash	Nut Type	ID			F1		F1	C	D Drop	CH1
			Dash	mm	in	Dash Size	mm				
1226180	-1212	TN	12	19,0	3/4"	12	3/4-14	59,1	61,0	32,0	
1226181	-1616	TN	16	25,0	1"	16	1-11	73,7	71,0	38,0	
1241625	-2020	TN	20	32,0	1 1/4"	20	1 1/4-11	84,3	83,0	50,0	
1238242	-2424	TN	24	38,0	1 1/2"	24	1 1/2-11	98,7	96,0	55,0	
1241626	-3232	TN	32	51,0	2"	32	2-11	140,5	130,0	70,0	

## // DIN METRIC INSERTS

### // H1311210

**Metric Male 24° Seat - Heavy**  
**DIN 3853 - CES**

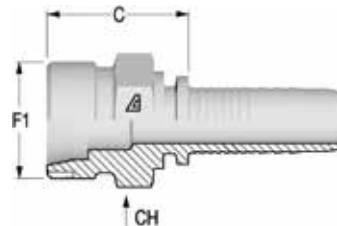

Item Code	Tale/Head	Nut Type	ID			F1	OD1	C	CH
	Dash/mm		Dash	mm	in		mm	mm	mm
1241605	-1236	NA	12	19,0	3/4"	M36X2	25	36,5	36,0
1226164	-1642	NA	16	25,0	1"	M42X2	30	36,2	46,0
1226165	-2052	NA	20	32,0	1 1/4"	M52X2	38	51,0	55,0

### // H1321613

**Metric Female 24° Cone with O-Ring - Heavy**  
**DIN 3865 - DKOS**

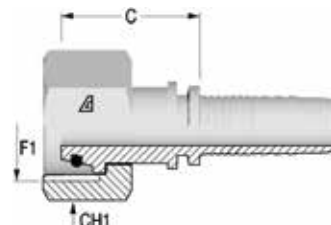

Item Code	Tale/Head	Nut Type	ID			F1	OD1	C	CH1
	Dash/mm		Dash	mm	in		mm	mm	mm
1226182	-1230	TN	12	19,0	3/4"	M30X2	20	36,8	36,0
1241632	-1236	SN	12	19,0	3/4"	M36X2	25	41,1	46,0
1240224	-1636	TN	16	25,0	1"	M36X2	25	46,0	46,0
1226184	-1642	SN	16	25,0	1"	M42X2	30	45,2	50,0
1242139	-2042	TN	20	32,0	1 1/4"	M42X2	30	51,0	50,0
1226185	-2052	SN	20	32,0	1 1/4"	M52X2	38	51,1	60,0
1238244	-2452	TN	24	38,0	1 1/2"	M52X2	38	58,0	60,0

Dimensions shown may be changed without prior notice

**// H1321643**

**45° Metric Female 24° Cone with O-Ring - Heavy**  
**DIN 3865 - DKOS 45**  
**Solid one piece**

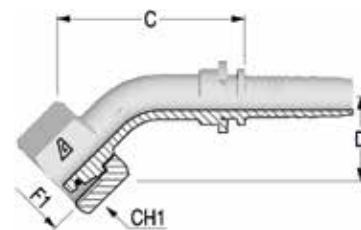

Item Code	Tale/Head Dash/mm	Nut Type	ID			F1	OD1 mm	C mm	D Drop mm	CH1 mm
			Dash	mm	in					
1242140	-1636	TN	16	25,0	1"	M36X2	25	86,5	37,5	46,0
1238246	-2052	SN	20	32,0	1 1/4"	M52X2	38	112,0	45,0	60,0
1238245	-2452	TN	24	38,0	1 1/2"	M52X2	38	127,0	45,0	60,0

**// H1321693**

**90° Metric Female 24° Cone with O-Ring - Heavy**  
**DIN 3865 - DKOS 90**  
**Solid one piece**

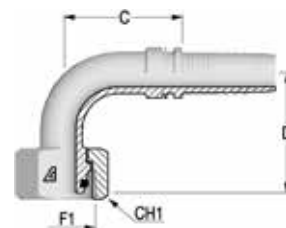

Item Code	Tale/Head Dash/mm	Nut Type	ID			F1	OD1 mm	C mm	D Drop mm	CH1 mm
			Dash	mm	in					
1241633	-1230	TN	12	19,0	3/4"	M30X2	20	65,5	67,5	36,0
1240225	-1636	TN	16	25,0	1"	M36X2	25	75,6	82,0	46,0
1238248	-2052	SN	20	32,0	1 1/4"	M52X2	38	97,0	92,0	60,0
1238247	-2452	TN	24	38,0	1 1/2"	M52X2	38	106,0	95,0	60,0

## // JIC 37° INSERTS

### // H1312510

**JIC Male 37° Cone  
AGJ**

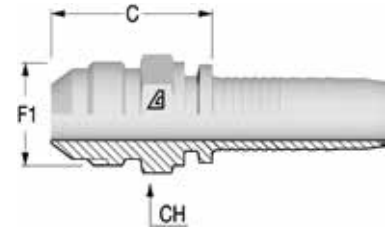

Item Code	Tale/Head	Nut Type	ID			F1	F1	C	CH
	Dash		Dash	mm	in	Dash Size	F1	mm	mm
1226168	-1212	NA	12	19,0	3/4"	12	1 1/16-12	38,5	27,0
1226169	-1616	NA	16	25,0	1"	16	1 5/16-12	45,5	36,0
1226170	-2020	NA	20	32,0	1 1/4"	20	1 5/8-12	51,5	46,0
1226171	-2424	NA	24	38,0	1 1/2"	24	1 7/8-12	57,5	50,0
1238091	-3232	NA	32	51,0	2"	32	2 1/2-12	77,0	65,0

### // H1322512

**JIC Female 37° Seat  
DKJ**

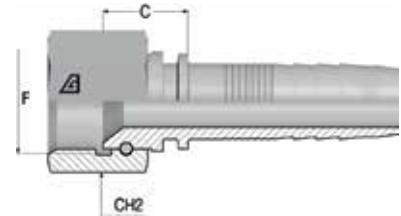

Item Code	Tale/Head	Nut Type	ID			F1	F1	C	CH1
	Dash		Dash	mm	in	Dash Size	F1	mm	mm
1241618	-1212	TN	12	19,0	3/4"	12	1 1/16-12	22,2	32,0
1241619	-1216	TN	12	19,0	3/4"	16	1 5/16-12	25,0	38,0
1241620	-1616	TN	16	25,0	1"	16	1 5/16-12	27,0	38,0
1241621	-1620	TN	16	25,0	1"	20	1 5/8-12	29,0	50,0
1241622	-2020	TN	20	32,0	1 1/4"	20	1 5/8-12	31,5	50,0
1241623	-2024	TN	20	32,0	1 1/4"	24	1 7/8-12	34,0	55,0
1241624	-2424	TN	24	38,0	1 1/2"	24	1 7/8-12	36,5	55,0
1238250	-3232	TN	32	51,0	2"	32	2 1/2-12	47,0	70,0

Dimensions shown may be changed without prior notice

**// H1322542**

**45° JIC Female 37° Seat - Medium Drop  
DKJ 45M  
Solid one piece**

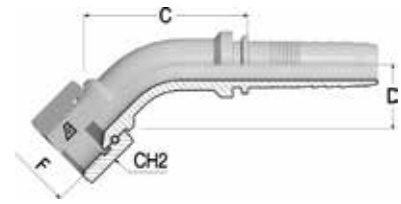

Item Code	Tale/Head Dash	Nut Type	ID			F1		F1	C	D Drop	CH1
			Dash	mm	in	Dash Size	mm				
1226205	-1212	TN	12	19,0	3/4"	12	1 1/16-12	69,5	27,5	32,0	
1241631	-1216	TN	12	19,0	3/4"	16	1 5/16-12	69,0	33,5	38,0	
1226206	-1616	TN	16	25,0	1"	16	1 5/16-12	84,8	31,0	38,0	
1226207	-2424	TN	24	38,0	1 1/2"	24	1 7/8-12	118,3	43,5	55,0	
1238252	-3232	TN	32	51,0	2"	32	2 1/2-12	162,3	51,5	70,0	

**// H1322592**

**90° JIC Female 37° Seat - Medium Drop  
DKJ 90M  
Solid one piece**

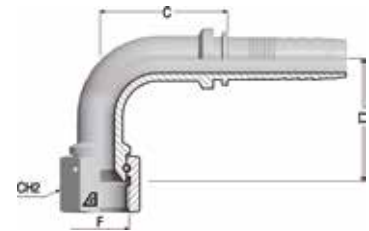

Item Code	Tale/Head Dash	Nut Type	ID			F1		F1	C	D Drop	CH1
			Dash	mm	in	Dash Size	mm				
1226209	-1212	TN	12	19,0	3/4"	12	1 1/16-12	59,1	57,0	32,0	
1226211	-1216	TN	12	19,0	3/4"	16	1 5/16-12	58,1	63,5	38,0	
1226212	-1616	TN	16	25,0	1"	16	1 5/16-12	75,7	67,0	38,0	
1238254	-2020	TN	20	32,0	1 1/4"	20	1 5/8-12	84,0	78,0	50,0	
1230690	-2424	TN	24	38,0	1 1/2"	24	1 7/8-12	105,3	92,0	55,0	
1238255	-3232	TN	32	51,0	2"	32	2 1/2-12	147,5	135,0	70,0	

## // NPTF INSERTS

### // H1312810

**NPTF Male 60° Seat  
AGN**

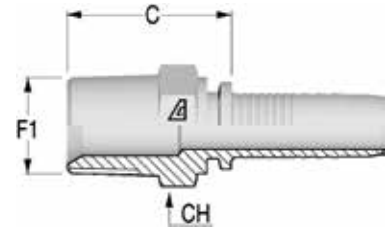

Item Code	Tale/Head	Nut Type	ID		F1		F1	C	CH
	Dash		Dash	mm	in	Dash Size			
1226172	-1212	NA	12	19,0	3/4"	12	3/4-14	35,5	27,0
1226173	-1616	NA	16	25,0	1"	16	1-11 1/2	46,5	36,0
1238093	-2020	NA	20	32,0	1 1/4"	20	1 1/4-11 1/2	41,0	46,0
1226174	-2424	NA	24	38,0	1 1/2"	24	1 1/2-11 1/2	55,5	50,0
1238095	-3232	NA	32	51,0	2"	32	2-11 1/2	69,2	65,0

Dimensions shown may be changed without prior notice

## // ORFS INSERTS

### // H1312410

ORFS Male

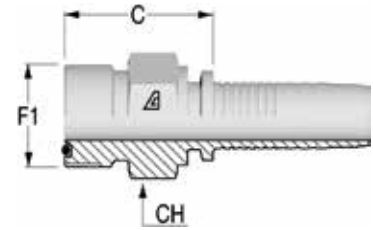

Item Code	Tale/Head	Nut Type	ID			F1	F1	C	CH
	Dash		Dash	mm	in	Dash Size	F1	mm	mm
1230556	-1212	NA	12	19,0	3/4"	12	1 3/16-12	32,7	32,0
1226166	-1616	NA	16	25,0	1"	16	1 7/16-12	35,7	38,0
1230557	-2020	NA	20	32,0	1 1/4"	20	1 11/16-12	38,7	46,0
1226167	-2424	NA	24	38,0	1 1/2"	24	2-12	41,8	55,0

### // H1322411

ORFS Female with Stem Hexagon

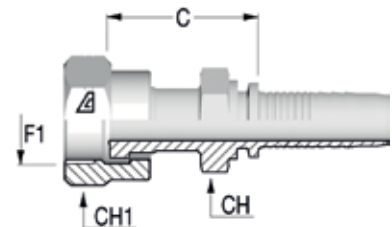

Item Code	Tale/Head	Nut Type	ID			F1	F1	C	CH	CH1
	Dash		Dash	mm	in	Dash Size	F1	mm	mm	mm
1226190	-1212	CR	12	19,0	3/4"	12	1 3/16-12	44,5	30,0	36,0
1226191	-1216	CR	12	19,0	3/4"	16	1 7/16-12	50,5	36,0	41,0
1242141	-1612	CR	16	25,0	1"	12	1 3/16-12	42,0	32,0	36,0
1226192	-1616	CR	16	25,0	1"	16	1 7/16-12	52,5	36,0	41,0
1226193	-1620	CR	16	25,0	1"	20	1 11/16-12	53,5	41,0	50,0
1226194	-2020	CR	20	32,0	1 1/4"	20	1 11/16-12	56,0	41,0	50,0
1226195	-2424	CR	24	38,0	1 1/2"	24	2-12	62,5	50,0	60,0



**// H1322441**

**45° ORFS Female - Medium Drop**  
**DK ORFS 45M**  
**Solid one piece**

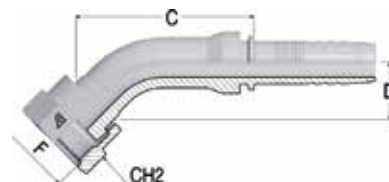

Item Code	Tale/Head Dash	Nut Type	ID			F1		C	D Drop	CH1
			Dash	mm	in	Dash Size	F1			
1226196	-1212	CR	12	19,0	3/4"	12	1 3/16-12	32,5	26,0	36,0
1226197	-1216	CR	12	19,0	3/4"	16	1 7/16-12	31,2	28,0	41,0
1226198	-1616	CR	16	25,0	1"	16	1 7/16-12	94,0	28,0	41,0
1241634	-1620	CR	16	25,0	1"	20	1 11/16-12	88,0	28,0	50,0
1238249	-2020	CR	20	32,0	1 1/4"	20	1 11/16-12	110,0	36,5	50,0

**// H1322491**

**90° ORFS Female - Medium Drop**  
**DK ORFS 90M**  
**Solid one piece**

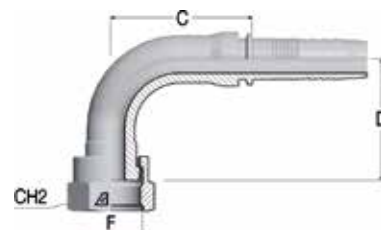

Item Code	Tale/Head Dash	Nut Type	ID			F1		C	D Drop	CH1
			Dash	mm	in	Dash Size	F1			
1226200	-1212	CR	12	19,0	3/4"	12	1 3/16-12	67,6	58,0	36,0
1226201	-1216	CR	12	19,0	3/4"	16	1 7/16-12	69,6	58,0	36,0
1226202	-1616	CR	16	25,0	1"	16	1 7/16-12	79,6	66,0	41,0
1241635	-1620	CR	16	25,0	1"	20	1 11/16-12	73,0	66,0	50,0
1226203	-2020	CR	20	32,0	1 1/4"	20	1 11/16-12	102,4	81,0	50,0

Dimensions shown may be changed without prior notice

## // SAE FLANGES

### // H1343310

Flange SAE 3000 PSI J518 Code 61 - SFL

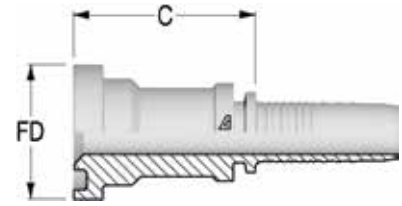

Item Code	Tale/Head		ID		Flange		C	FD	WP
	Dash	Dash	mm	in	Dash Size	Flange Size			
1226222	-1212	12	19,0	3/4"	12	3/4	43,5	38,1	5000
1226224	-1616	16	25,0	1"	16	1	53,5	44,5	5000
1226225	-1620	16	25,0	1"	20	1 1/4	56,0	50,8	5000
1241602	-2016	20	32,0	1 1/4"	16	1	58,5	44,4	5000
1226227	-2020	20	32,0	1 1/4"	20	1 1/4	58,5	50,8	5000
1241604	-2024	20	32,0	1 1/4"	24	1 1/2	61,5	60,3	5000
1241603	-2420	24	38,0	1 1/2"	20	1 1/4	55,5	50,8	5000
1226228	-2424	24	38,0	1 1/2"	24	1 1/2	63,5	60,3	5000
1226229	-2432	24	38,0	1 1/2"	32	2	75,0	71,4	5000
1235374	-3232	32	50,0	2"	32	2	85,0	71,4	5000

### // H1343340

45° Flange SAE 3000 PSI J518 Code 61 - SFL 45  
Solid one piece

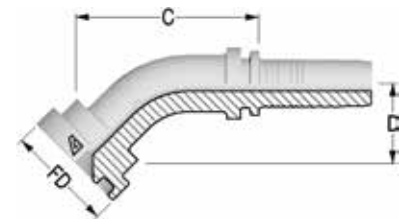

Item Code	Tale/Head		ID		Flange		FD	C	D Drop	WP
	Dash	Dash	mm	in	Dash Size	Flange Size				
1226233	-1620	16	25,0	1"	20	1 1/4	50,8	88,9	32,5	5000
1226234	-2020	20	32,0	1 1/4"	20	1 1/4	50,8	94,3	38,5	5000
1226235	-2424	24	38,0	1 1/2"	24	1 1/2	60,3	99,8	43,0	5000
1235374	-3232	32	50,0	2"	32	2	71,4	154,0	54,0	5000

**// H1343390**

**90° Flange SAE 3000 PSI J518 Code 61 - SFL 90**  
**Solid one piece**

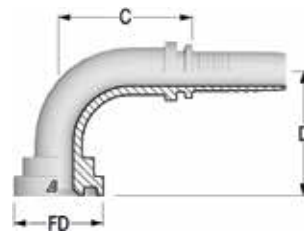

Item Code	Tale/Head	ID	Flange	Flange Size	FD	C	D Drop	WP		
	Dash								Dash	Dash Size
1226241	-1616	16	25,0	1"	16	1	44,5	78,1	64,0	5000
1226242	-1620	16	25,0	1"	20	1 1/4	50,8	74,7	69,0	5000
1226244	-2020	20	32,0	1 1/4"	20	1 1/4	50,8	92,0	81,0	5000
1241608	-2024	20	32,0	1 1/4"	24	1 1/2	60,3	87,0	85,0	5000
1226245	-2424	24	38,0	1 1/2"	24	1 1/2	60,3	103,0	93,0	5000
1226246	-2432	24	38,0	1 1/2"	32	2	71,4	137,8	97,0	5000
1235375	-3232	32	50,0	2"	32	2	71,4	139,0	130,0	5000

**// H1343610**

**Flange SAE 6000 PSI J518 Code 62 - SFS**

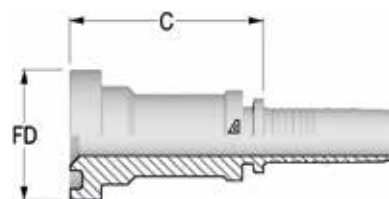

Item Code	Tale/Head	ID	Flange	Flange Size	C	FD	WP		
	Dash							Dash	Dash Size
1226247	-1212	12	19,0	3/4"	12	3/4	53,5	41,3	6000
1226248	-1216	12	19,0	3/4"	16	1	56,5	47,6	6000
1226250	-1616	16	25,0	1"	16	1	58,5	47,6	6000
1226624	-1620	16	25,0	1"	20	1 1/4	65,5	54,0	6000
1236992	-2016	20	32,0	1 1/4"	16	1	61,0	47,6	6000
1226252	-2020	20	32,0	1 1/4"	20	1 1/4	64,0	54,0	6000
1226253	-2024	20	32,0	1 1/4"	24	1 1/2	74,0	63,5	6000
1241614	-2420	24	38,0	1 1/2"	20	1 1/4	71,0	54,0	6000
1226254	-2424	24	38,0	1 1/2"	24	1 1/2	76,0	63,5	6000
1226255	-2432	24	38,0	1 1/2"	32	2	88,0	79,4	6000
1241615	-3224	32	51,0	2"	24	1 1/2	86,0	63,5	6000
1235378	-3232	32	50,0	2"	32	2	103,0	79,4	6000

Dimensions shown may be changed without prior notice

**// H1343640**

**45° Flange SAE 6000 PSI J518 Code 62 - SFS 45**  
**Solid one piece**

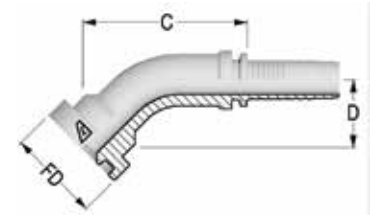

Item Code	Tale/Head		ID		Flange		Flange Size	FD	C	D Drop	WP
	Dash	Dash	mm	in	Dash Size	Dash Size					
1226261	-1212	12	19,0	3/4"	12	3/4	41,3	62,8	30,0	6000	
1226262	-1216	12	19,0	3/4"	16	1	47,6	65,4	33,0	6000	
1241609	-1612	16	25,0	1"	12	3/4	41,3	77,0	29,5	6000	
1226263	-1616	16	25,0	1"	16	1	47,6	82,9	38,5	6000	
1226264	-1620	16	25,0	1"	20	1 1/4	54,0	78,0	44,0	6000	
1242142	-2016	20	32,0	1 1/4"	16	1	47,6	104,7	34,5	6000	
1238305	-2020	20	32,0	1 1/4"	20	1 1/4	54,0	103,0	41,0	6000	
1241610	-2024	20	32,0	1 1/4"	24	1 1/2	63,5	117,0	48,0	6000	
1226265	-2424	24	38,0	1 1/2"	24	1 1/2	63,5	122,5	48,0	6000	
1226266	-2432	24	38,0	1 1/2"	32	2	79,4	109,6	55,0	6000	
1235379	-3232	32	50,0	2"	32	2	79,4	177,0	61,0	6000	

**// H1343690**

**90° Flange SAE 6000 PSI J518 Code 62 - SFS 90**  
**Solid one piece**

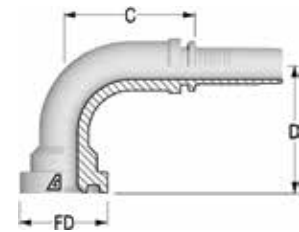

Item Code	Tale/Head		ID		Flange		Flange Size	FD	C	D Drop	WP
	Dash	Dash	mm	in	Dash Size	Dash Size					
1226270	-1212	12	19,0	3/4"	12	3/4	41,3	64,7	64,0	6000	
1226271	-1216	12	19,0	3/4"	16	1	47,6	64,7	66,0	6000	
1226273	-1616	16	25,0	1"	16	1	47,6	74,8	74,0	6000	
1226274	-1620	16	25,0	1"	20	1 1/4	54,0	78,8	85,0	6000	
1241611	-2016	20	32,0	1 1/4"	16	1	47,6	87,0	72,0	6000	
1230765	-2020	20	32,0	1 1/4"	20	1 1/4	54,0	96,0	91,0	6000	
1238310	-2024	20	32,0	1 1/4"	24	1 1/2	63,5	99,0	103,5	6000	
1226276	-2424	24	38,0	1 1/2"	24	1 1/2	63,5	113,8	109,0	6000	
1226277	-2432	24	38,0	1 1/2"	32	2	79,4	118,4	121,5	6000	
1235381	-3232	32	50,0	2"	32	2	79,4	172,0	131,0	6000	

## // SUPERCAT FLANGES

### // H1343910

#### Flange SUPERCAT

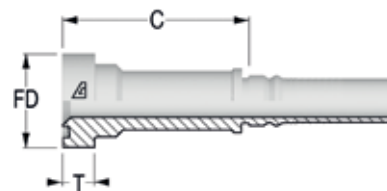

Item Code	Tale/Head		ID		Flange		Flange Size	FD	T	C
	Dash	Dash	mm	in	Dash Size	mm		mm	mm	
1226278	-1212	12	19,0	3/4"	12	3/4	41,3	14,3	85,5	
1226279	-1216	12	19,0	3/4"	16	1	47,6	14,3	85,5	
1226280	-1616	16	25,0	1"	16	1	47,6	14,3	94,5	
1226281	-1620	16	25,0	1"	20	1 1/4	54,0	14,3	94,5	
1226282	-2020	20	32,0	1 1/4"	20	1 1/4	54,0	14,3	92,0	
1226283	-2024	20	32,0	1 1/4"	24	1 1/2	63,5	14,3	87,0	

### // H1343940

#### 45° Flange SUPERCAT Solid one piece

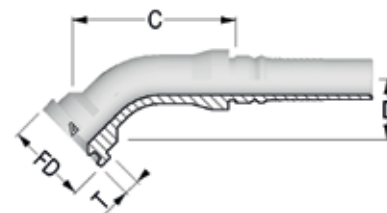

Item Code	Tale/Head		ID		Flange		Flange Size	FD	T	C	D Drop
	Dash	Dash	mm	in	Dash Size	mm		mm	mm	mm	
1226289	-1212	12	19,0	3/4"	12	3/4	41,3	14,3	107,0	34,0	
1241612	-1216	12	19,0	3/4"	16	1	47,6	14,3	112,0	34,0	
1226290	-1616	16	25,0	1"	16	1	47,6	14,3	129,0	42,5	
1226291	-1620	16	25,0	1"	20	1 1/4	54,0	14,3	128,0	40,0	
1226292	-2020	20	32,0	1 1/4"	20	1 1/4	54,0	14,3	150,0	45,1	
1238317	-2024	20	32,0	1 1/4"	24	1 1/2	63,5	14,3	152,0	60,0	

Dimensions shown may be changed without prior notice

**// H1343990**

**90° Flange SUPERCAT**  
**Solid one piece**

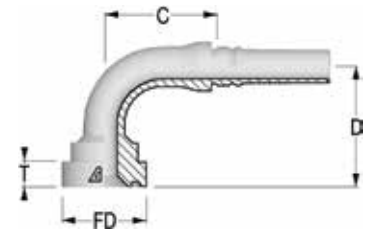

Item Code	Tale/Head		ID		Flange		Flange Size	FD	T	C	D Drop
	Dash	Dash	mm	in	Dash Size	Dash Size					
1226297	-1212	12	19,0	3/4"	12	12	3/4	41,3	14,3	67,2	67,0
1226298	-1216	12	19,0	3/4"	16	16	1	47,6	14,3	68,7	70,0
1226299	-1616	16	25,0	1"	16	16	1	47,6	14,3	84,8	79,0
1226301	-1620	16	25,0	1"	20	20	1 1/4	54,0	14,3	79,8	82,5
1238312	-2020	20	32,0	1 1/4"	20	20	1 1/4	54,0	14,3	97,0	93,0
1238315	-2024	20	32,0	1 1/4"	24	24	1 1/2	63,5	14,3	97,0	101,0



## // INTERLOCK

// FERRULES.....	119	// NPTF INSERTS .....	127
// HOSE MENDER.....	120	// ORFS INSERTS .....	128
// BSP INSERTS .....	121	// SAE FLANGES .....	130
// DIN METRIC INSERTS .....	123	// SUPERCAT FLANGES .....	134
// JIC 37° INSERTS.....	125	// HAMMER UNION.....	135

Dimensions shown may be changed without prior notice

## // FERRULES

### // H1400200

Interlock Ferrule

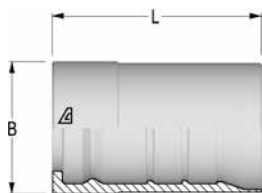

Item Code	ID			OD mm	L mm
	Dash	mm	in		
1201571	06	10,0	3/8"	27,0	49,0
1201856	08	13,0	1/2"	30,0	52,5
1201502	10	16,0	5/8"	34,0	57,5
1201503	12	19,0	3/4"	38,0	60,2
1201504	16	25,0	1"	46,0	74,7
1200098	20	31,0	1 1/4"	55,0	88,2
1200099	24	38,0	1 1/2"	62,0	94,2
1201284	32	51,0	2"	78,0	99,2

### // H1T00600

Interlock Ferrule

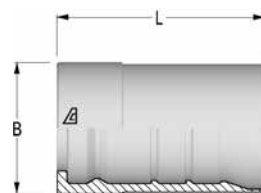

Item Code	ID			OD mm	L mm
	Dash	mm	in		
1225872	32	51,0	2"	88,1	108,2

### // H1400301

Interlock Ferrule

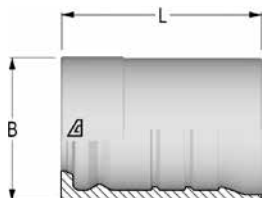

Item Code	ID			OD mm	L mm
	Dash	mm	in		
1202585	10	16,0	5/8"	35,5	57,5
1202730	12	19,0	3/4"	43,5	60,0
1202222	16	25,0	1"	52,0	75,0
1201761	20	31,0	1 1/4"	62,0	88,0
1201805	24	38,0	1 1/2"	69,5	94,0
1202006	32	51,0	2"	88,0	99,0



## // HOSE MENDER

### // H14C5610

Hose Mender



Item Code	Tale/Head	ID			F1
	Dash	Dash	mm	in	Dash Size
1219636	-1010	10	16,0	5/8"	10
1235392	-2020	20	32,0	1 1/4"	20
1235393	-2424	24	38,0	1 1/2"	24
1235394	-3232	32	51,0	2"	32

Dimensions shown may be changed without prior notice

## // BSP INSERTS

### // H1410510

**BSPP Male 60° Flare  
AGR**

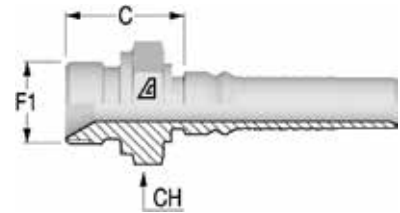

Item Code	Tale/Head	Nut Type	ID			F1	F1	C	CH
	Dash		Dash	mm	in	Dash Size			
1200218	-1212	NA	12	19,0	3/4"	12	3/4-14	34,0	32,0
1200239	-1616	NA	16	25,0	1"	16	1-11	40,0	41,0
1201219	-2020	NA	20	32,0	1 1/4"	20	1 1/4-11	45,2	50,0
1200280	-2424	NA	24	38,0	1 1/2"	24	1 1/2-11	48,5	55,0
1201080	-3232	NA	32	51,0	2"	32	2-11	55,5	70,0

### // H1410710

**BSPT Male  
AGR K**

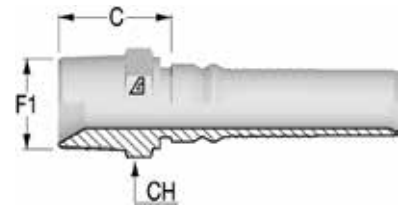

Item Code	Tale/Head	Nut Type	ID			F1	F1	C	CH
	Dash		Dash	mm	in	Dash Size			
1200215	-1212	NA	12	19,0	3/4"	12	3/4-14	32,0	27,0
1200237	-1616	NA	16	25,0	1"	16	1-11	42,0	36,0
1200261	-2020	NA	20	32,0	1 1/4"	20	1 1/4-11	46,2	46,0
1200278	-2424	NA	24	38,0	1 1/2"	24	1 1/2-11	48,0	50,0

### // H1420812

**BSPP Female 60° Cone with O-Ring  
DKOR**

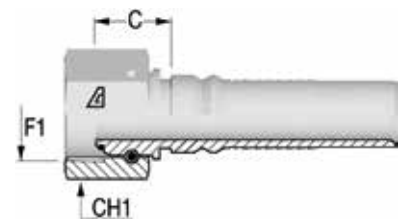

Item Code	Tale/Head	Nut Type	ID			F1	F1	C	CH1
	Dash		Dash	mm	in	Dash Size			
1214247	-0808	CR	08	13,0	1/2"	08	1/2-14	19,5	27,0
1202424	-1212	TN	12	19,0	3/4"	12	3/4-14	22,5	32,0
1202440	-1616	TN	16	25,0	1"	16	1-11	25,5	38,0
1201132	-2020	TN	20	32,0	1 1/4"	20	1 1/4-11	30,2	50,0
1201134	-2424	TN	24	38,0	1 1/2"	24	1 1/2-11	33,5	55,0
1201136	-3232	TN	32	51,0	2"	32	2-11	35,0	70,0

**// H1420842**

**45° BSPP Female 60° Cone with O-Ring  
DKOR 45  
Solid one piece**

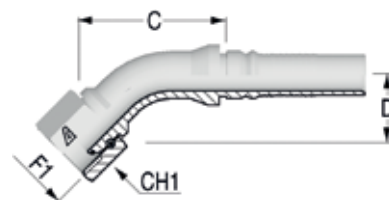

Item Code	Tale/Head Dash	Nut Type	ID			F1		C	D Drop	CH1
			Dash	mm	in	Dash Size	F1			
1202447	-1212	TN	12	19,0	3/4"	12	3/4-14	72,0	30,0	32,0
1202446	-1616	TN	16	25,0	1"	16	1-11	81,0	34,0	38,0
1202444	-2020	TN	20	32,0	1 1/4"	20	1 1/4-11	97,2	40,0	50,0
1202442	-2424	TN	24	38,0	1 1/2"	24	1 1/2-11	113,0	46,0	55,0
1201535	-3232	TN	32	51,0	2"	32	2-11	151,0	60,0	70,0

**// H1420892**

**90° BSPP Female 60° Cone with O-Ring  
DKOR 90  
Solid one piece**

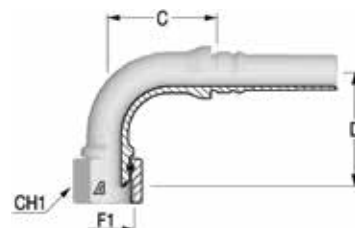

Item Code	Tale/Head Dash	Nut Type	ID			F1		C	D Drop	CH1
			Dash	mm	in	Dash Size	F1			
1200217	-1212	TN	12	19,0	3/4"	12	3/4-14	58,0	61,0	32,0
1202445	-1616	TN	16	25,0	1"	16	1-11	75,0	71,0	38,0
1202443	-2020	TN	20	32,0	1 1/4"	20	1 1/4-11	79,2	83,0	50,0
1202441	-2424	TN	24	38,0	1 1/2"	24	1 1/2-11	93,5	96,0	55,0
1200288	-3232	TN	32	51,0	2"	32	2-11	134,0	125,0	70,0

Dimensions shown may be changed without prior notice

## // DIN METRIC INSERTS

### // H1411210

**Metric Male 24° Seat - Heavy**  
**DIN 3853 - CES**

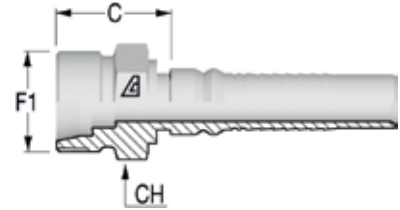

Item Code	Tale/Head Dash/mm	Nut Type	ID			F1	OD1 mm	C mm	CH mm
			Dash	mm	in				
1216929	-0824	NA	08	13,0	1/2"	M24X1.5	16	27,0	24,0
1201077	-1030	NA	10	16,0	5/8"	M30X2	20	31,0	32,0
1200212	-1236	NA	12	19,0	3/4"	M36X2	25	35,0	36,0
1200236	-1642	NA	16	25,0	1"	M42X2	30	40,0	46,0
1200260	-2052	NA	20	32,0	1 1/4"	M52X2	38	45,2	55,0

### // H1421613

**Metric Female 24° Cone with O-Ring - Heavy**  
**DIN 3865 - DKOS**

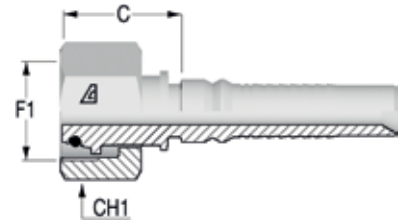

Item Code	Tale/Head Dash/mm	Nut Type	ID			F1	OD1 mm	C mm	CH1 mm
			Dash	mm	in				
1201857	-0824	SN	08	13,0	1/2"	M24X1.5	16	29,6	30,0
1201118	-1030	SN	10	16,0	5/8"	M30X2	20	34,4	36,0
1202584	-1230	TN	12	19,0	3/4"	M30X2	20	37,5	36,0
1201092	-1236	SN	12	19,0	3/4"	M36X2	25	37,6	46,0
1202887	-1636	TN	16	25,0	1"	M36X2	25	38,8	46,0
1201125	-1642	SN	16	25,0	1"	M42X2	30	40,7	50,0
1216935	-2042	TN	20	32,0	1 1/4"	M42X2	30	43,6	50,0
1201129	-2052	SN	20	32,0	1 1/4"	M52X2	38	45,3	60,0
1216936	-2452	TN	24	38,0	1 1/2"	M52X2	38	50,8	60,0

**// H1421643**

**45° Metric Female 24° Cone with O-Ring - Heavy  
DIN 3865 - DKOS 45  
Solid one piece**

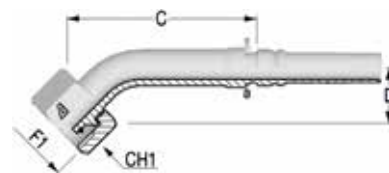

Item Code	Tale/Head Dash/mm	Nut Type	ID			F1	OD1 mm	C mm	D Drop mm	CH1 mm
			Dash	mm	in					
1216942	-0824	SN	08	13,0	1/2"	M24X1.5	16	83,0	29,0	30,0
1202073	-1030	SN	10	16,0	5/8"	M30X2	20	59,0	31,5	36,0
1202583	-1230	TN	12	19,0	3/4"	M30X2	20	74,0	33,0	36,0
1202079	-1236	SN	12	19,0	3/4"	M36X2	25	78,1	36,0	46,0
1216940	-1636	TN	16	25,0	1"	M36X2	25	86,5	37,5	46,0
1201724	-1642	SN	16	25,0	1"	M42X2	30	96,8	38,0	50,0
1202003	-2052	SN	20	32,0	1 1/4"	M52X2	38	112,7	48,0	60,0
1216941	-2452	TN	24	38,0	1 1/2"	M52X2	38	111,0	44,0	60,0

**// H1421693**

**90° Metric Female 24° Cone with O-Ring - Heavy  
DIN 3865 - DKOS 90  
Solid one piece**

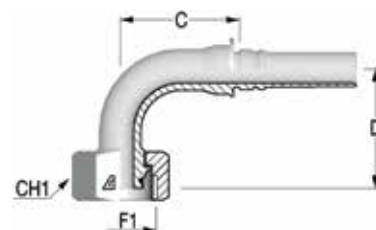

Item Code	Tale/Head Dash/mm	Nut Type	ID			F1	OD1 mm	C mm	D Drop mm	CH1 mm
			Dash	mm	in					
1203125	-0824	SN	08	13,0	1/2"	M24X1.5	16	52,0	50,0	30,0
1202072	-1030	SN	10	16,0	5/8"	M30X2	20	48,0	55,0	36,0
1202582	-1230	TN	12	19,0	3/4"	M30X2	20	61,0	67,5	36,0
1201723	-1236	SN	12	19,0	3/4"	M36X2	25	61,7	65,0	46,0
1203126	-1636	TN	16	25,0	1"	M36X2	25	76,5	76,5	46,0
1201740	-1642	SN	16	25,0	1"	M42X2	30	86,4	79,0	50,0
1201059	-2052	SN	20	32,0	1 1/4"	M52X2	38	90,9	101,0	60,0
1216945	-2452	TN	24	38,0	1 1/2"	M52X2	38	100,5	102,0	60,0

Dimensions shown may be changed without prior notice

## // JIC 37° INSERTS

### // H1412510

JIC Male 37° Cone  
AGJ

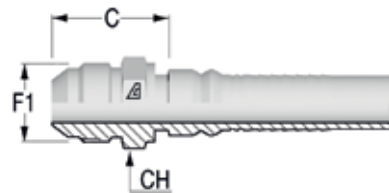

Item Code	Tale/Head	Nut Type	ID			F1	F1	C	CH
	Dash		Dash	mm	in	Dash Size	F1	mm	mm
1200216	-1212	NA	12	19,0	3/4"	12	1 1/16-12	37,0	32,0
1201094	-1216	NA	12	19,0	3/4"	16	1 5/16-12	40,0	36,0
1200238	-1616	NA	16	25,0	1"	16	1 5/16-12	41,0	36,0
1201787	-1620	NA	16	25,0	1"	20	1 5/8-12	44,5	46,0
1200262	-2020	NA	20	32,0	1 1/4"	20	1 5/8-12	45,7	46,0
1216931	-2024	NA	20	32,0	1 1/4"	24	1 7/8-12	49,7	50,0
1200279	-2424	NA	24	38,0	1 1/2"	24	1 7/8-12	50,0	50,0
1201798	-3232	NA	32	51,0	2"	32	2 1/2-12	61,0	65,0

### // H1422512

JIC Female 37° Seat  
DKJ

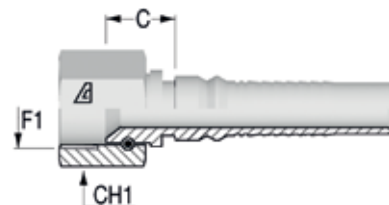

Item Code	Tale/Head	Nut Type	ID			F1	F1	C	CH1
	Dash		Dash	mm	in	Dash Size	F1	mm	mm
1201265	-1012	TN	10	16,0	5/8"	12	1 1/16-12	18,7	32,0
1201121	-1212	TN	12	19,0	3/4"	12	1 1/16-12	18,7	32,0
1201122	-1216	TN	12	19,0	3/4"	16	1 5/16-12	21,5	38,0
1201126	-1616	TN	16	25,0	1"	16	1 5/16-12	22,5	38,0
1201127	-1620	TN	16	25,0	1"	20	1 5/8-12	24,5	50,0
1201131	-2020	TN	20	32,0	1 1/4"	20	1 5/8-12	25,7	50,0
1216973	-2024	TN	20	32,0	1 1/4"	24	1 7/8-12	28,2	55,0
1201133	-2424	TN	24	38,0	1 1/2"	24	1 7/8-12	29,0	55,0
1201135	-3232	TN	32	51,0	2"	32	2 1/2-12	34,0	70,0

**// H1422542**

**45° JIC Female 37° Seat  
DKJ 45  
Solid one piece**

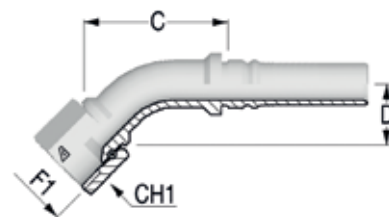

Item Code	Tale/Head Dash	Nut Type	ID			F1		F1	C	D Drop	CH1
			Dash	mm	in	Dash Size	mm				
1201485	-1212	TN	12	19,0	3/4"	12	1 1/16-12	66,0	27,5	32,0	
1202098	-1216	TN	12	19,0	3/4"	16	1 5/16-12	72,0	30,0	38,0	
1201486	-1616	TN	16	25,0	1"	16	1 5/16-12	79,5	31,0	38,0	
1201487	-2020	TN	20	32,0	1 1/4"	20	1 5/8-12	93,0	37,0	50,0	
1201765	-2424	TN	24	38,0	1 1/2"	24	1 7/8-12	121,0	38,0	55,0	

**// H1422592**

**90° JIC Female 37° Seat  
DKJ 90  
Solid one piece**

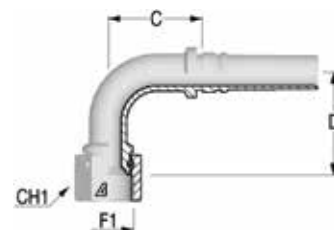

Item Code	Tale/Head Dash	Nut Type	ID			F1		F1	C	D Drop	CH1
			Dash	mm	in	Dash Size	mm				
1201488	-1212	TN	12	19,0	3/4"	12	1 1/16-12	45,0	57,0	32,0	
1202103	-1216	TN	12	19,0	3/4"	16	1 5/16-12	58,0	60,5	38,0	
1201489	-1616	TN	16	25,0	1"	16	1 5/16-12	71,0	67,0	38,0	
1201490	-2020	TN	20	32,0	1 1/4"	20	1 5/8-12	79,2	78,0	50,0	
1201491	-2424	TN	24	38,0	1 1/2"	24	1 7/8-12	94,5	92,0	55,0	
1201796	-3232	TN	32	51,0	2"	32	2 1/2-12	132,0	120,5	70,0	

Dimensions shown may be changed without prior notice

## // NPTF INSERTS

### // H1412810

**NPTF Male 60° Seat  
AGN**

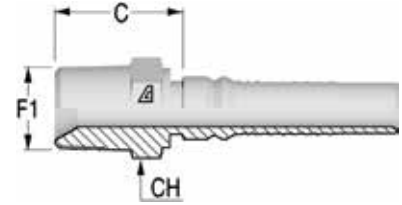

Item Code	Tale/Head	Nut Type	ID			F1	F1	C	CH
	Dash		Dash	mm	in	Dash Size		mm	mm
1201609	-0606	NA	06	10,0	3/8"	06	3/8-18	26,5	19,0
1203127	-0808	NA	08	13,0	1/2"	08	1/2-14	30,0	22,0
1200193	-1212	NA	12	19,0	3/4"	12	3/4-14	32,0	27,0
1200219	-1616	NA	16	25,0	1"	16	1-11 1/2	42,0	36,0
1200240	-2020	NA	20	32,0	1 1/4"	20	1 1/4-11 1/2	46,2	46,0
1200263	-2424	NA	24	38,0	1 1/2"	24	1 1/2-11 1/2	48,0	50,0
1200281	-3232	NA	32	51,0	2"	32	2-11 1/2	53,2	65,0



## // ORFS INSERTS

### // H1412410 ORFS Male

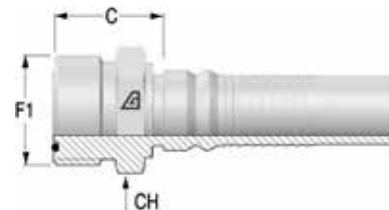

Item Code	Tale/Head	Nut Type	ID			F1	F1	C	CH
	Dash		Dash	mm	in	Dash Size		mm	mm
1214664	-1212	NA	12	19,0	3/4"	12	1 3/16-12	30200,0	30,0
1231483	-1616	NA	16	25,0	1"	16	1 7/16-12	35,8	38,0
1226310	-2020	NA	20	32,0	1 1/4"	20	1 11/16-12	39,1	46,0
1226311	-2024	NA	20	32,0	1 1/4"	24	2-12	40,7	55,0
1226312	-2424	NA	24	38,0	1 1/2"	24	2-12	41,0	55,0

### // H1422411 ORFS Female with Stem Hexagon

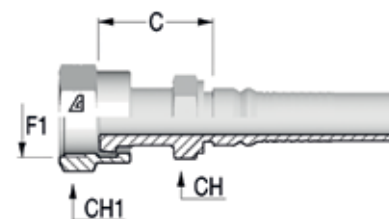

Item Code	Tale/Head	Nut Type	ID			F1	F1	C	CH	CH1
	Dash		Dash	mm	in	Dash Size		mm	mm	mm
1202864	-1012	CR	10	16,0	5/8"	12	1 3/16-12	40,0	30,0	36,0
1202099	-1212	CR	12	19,0	3/4"	12	1 3/16-12	40,0	30,0	36,0
1202106	-1216	CR	12	19,0	3/4"	16	1 7/16-12	43,0	36,0	41,0
1216952	-1612	CR	16	25,0	1"	12	1 3/16-12	42,0	32,0	36,0
1202071	-1616	CR	16	25,0	1"	16	1 7/16-12	47,0	36,0	41,0
1202107	-1620	CR	16	25,0	1"	20	1 11/16-12	49,0	46,0	50,0
1216955	-2016	CR	20	32,0	1 1/4"	16	1 7/16-12	47,2	41,0	41,0
1201807	-2020	CR	20	32,0	1 1/4"	20	1 11/16-12	47,2	46,0	50,0
1216956	-2424	CR	24	38,0	1 1/2"	24	2-12	52,0	50,0	60,0

Dimensions shown may be changed without prior notice

**// H1422441**

**45° ORFS Female  
DK ORFS 45  
Solid one piece**

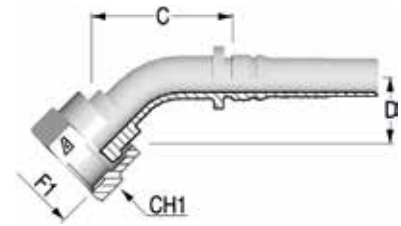

Item Code	Tale/Head Dash	Nut Type	ID			F1		F1	C	D Drop	CH1
			Dash	mm	in	Dash Size	mm				
1202108	-1212	CR	12	19,0	3/4"	12	1 3/16-12	77,7	26,0	36,0	
1202109	-1216	CR	12	19,0	3/4"	16	1 7/16-12	68,4	28,0	41,0	
1202110	-1616	CR	16	25,0	1"	16	1 7/16-12	114,0	28,0	41,0	
1202111	-1620	CR	16	25,0	1"	20	1 11/16-12	83,4	28,0	50,0	
1202112	-2020	CR	20	32,0	1 1/4"	20	1 11/16-12	100,7	33,0	50,0	

**// H1422491**

**90° ORFS Female  
DK ORFS 90  
Solid one piece**

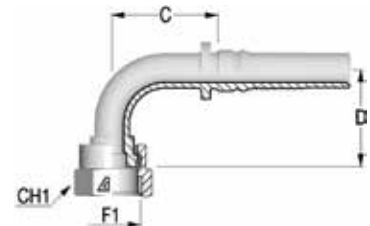

Item Code	Tale/Head Dash	Nut Type	ID			F1		F1	C	D Drop	CH1
			Dash	mm	in	Dash Size	mm				
1203123	-1012	CR	10	16,0	5/8"	12	1 3/16-12	48,1	58,0	36,0	
1202117	-1212	CR	12	19,0	3/4"	12	1 3/16-12	64,2	58,0	36,0	
1202116	-1216	CR	12	19,0	3/4"	16	1 7/16-12	66,2	58,0	41,0	
1202115	-1616	CR	16	25,0	1"	16	1 7/16-12	75,2	66,0	41,0	
1202114	-1620	CR	16	25,0	1"	20	1 11/16-12	73,2	66,0	50,0	
1202113	-2020	CR	20	32,0	1 1/4"	20	1 11/16-12	91,7	81,0	50,0	

## // SAE FLANGES

### // H1443310

Flange SAE 3000 PSI J518 Code 61 - SFL

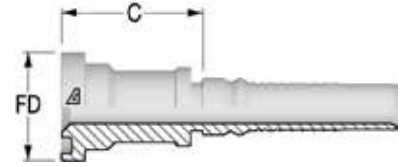

Item Code	Tale/Head	ID		Flange		Flange Size	C	FD	WP
	Dash	Dash	mm	in	Dash Size				
1200233	-1616	16	25,0	1"	16	1	49,0	44,5	5000
1200234	-1620	16	25,0	1"	20	1 1/4	51,5	50,8	4000
1200257	-2020	20	32,0	1 1/4"	20	1 1/4	52,7	50,8	4000
1200256	-2024	20	32,0	1 1/4"	24	1 1/2	55,7	60,3	3000
1200276	-2424	24	38,0	1 1/2"	24	1 1/2	56,0	60,3	3000
1200277	-2432	24	38,0	1 1/2"	32	2	67,5	71,4	3000
1200287	-3232	32	51,0	2"	32	2	69,0	71,4	3000

### // H1443340

45° Flange SAE 3000 PSI J518 Code 61 - SFL 45  
Solid one piece

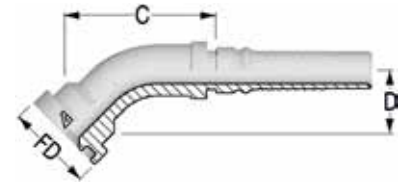

Item Code	Tale/Head	ID		Flange		Flange Size	FD	C	D Drop	WP
	Dash	Dash	mm	in	Dash Size					
1200230	-1620	16	25,0	1"	20	1 1/4	50,8	95,6	30,0	4000
1200253	-2020	20	32,0	1 1/4"	20	1 1/4	50,8	100,9	32,5	4000
1200252	-2024	20	32,0	1 1/4"	24	1 1/2	60,3	92,8	40,0	3000
1200272	-2424	24	38,0	1 1/2"	24	1 1/2	60,3	103,7	43,0	3000
1200273	-2432	24	38,0	1 1/2"	32	2	71,4	132,7	56,5	3000
1200285	-3232	32	51,0	2"	32	2	71,4	138,1	54,0	3000

### // H1443390

90° Flange SAE 3000 PSI J518 Code 61 - SFL 90  
Solid one piece

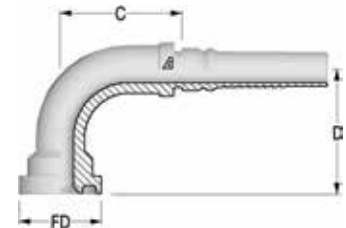

Item Code	Tale/Head	ID		Flange		Flange Size	FD	C	D Drop	WP
	Dash	Dash	mm	in	Dash Size					
1200231	-1616	16	25,0	1"	16	1	44,5	72,2	64,0	5000
1200232	-1620	16	25,0	1"	20	1 1/4	50,8	70,2	69,0	4000
1200255	-2020	20	32,0	1 1/4"	20	1 1/4	50,8	86,2	81,0	4000
1200254	-2024	20	32,0	1 1/4"	24	1 1/2	60,3	81,2	85,0	3000
1200274	-2424	24	38,0	1 1/2"	24	1 1/2	60,3	95,5	93,0	3000
1200275	-2432	24	38,0	1 1/2"	32	2	71,4	130,3	97,0	3000
1200286	-3232	32	51,0	2"	32	2	71,4	134,4	130,0	3000

Dimensions shown may be changed without prior notice

**// H1443610**

**Flange SAE 6000 PSI J518 Code 62 - SFS**

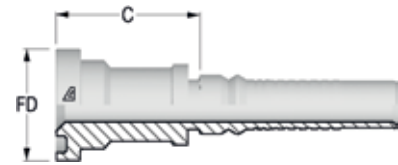

Item Code	Tale/Head	ID		Flange		C	FD	WP	
	Dash	Dash	mm	in	Dash Size				Flange Size
1200199	-1212	12	19,0	3/4"	12	3/4	50,0	41,3	6000
1200198	-1216	12	19,0	3/4"	16	1	53,0	47,6	6000
1201218	-1612	16	25,0	1"	12	3/4	51,0	41,3	6000
1200224	-1616	16	25,0	1"	16	1	54,0	47,6	6000
1200225	-1620	16	25,0	1"	20	1 1/4	61,0	54,0	6000
1201556	-2016	20	32,0	1 1/4"	16	1	80,2	47,6	6000
1242103	-2020	20	32,0	1 1/4"	20	1 1/4	87,1	54,0	6000
1242102	-2020	20	32,0	1 1/4"	20	1 1/4	79,2	54,0	6000
1200246	-2020	20	32,0	1 1/4"	20	1 1/4	62,2	54,0	6000
1200245	-2024	20	32,0	1 1/4"	24	1 1/2	68,2	63,5	6000
1200270	-2420	24	38,0	1 1/2"	20	1 1/4	62,5	54,0	6000
1242101	-2424	24	38,0	1 1/2"	24	1 1/2	104,5	63,5	6000
1200268	-2424	24	38,0	1 1/2"	24	1 1/2	68,5	63,5	6000
1200271	-2432	24	38,0	1 1/2"	32	2	80,5	79,4	6000
1242100	-2432	24	38,0	1 1/2"	32	2	88,0	79,4	6000
1200284	-3232	32	51,0	2"	32	2	87,0	79,4	6000
1242099	-3232	32	51,0	2"	32	2	104,0	79,4	6000

**// H1443640**

**45° Flange SAE 6000 PSI J518 Code 62 - SFS 45  
Solid one piece**

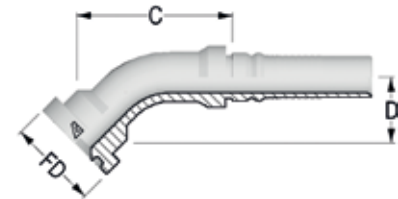

Item Code	Tale/Head	ID		Flange		FD	C	D Drop	WP	
	Dash	Dash	mm	in	Dash Size					Flange Size
1200195	-1212	12	19,0	3/4"	12	3/4	41,3	72,1	30,0	6000
1200194	-1216	12	19,0	3/4"	16	1	47,6	76,8	33,0	6000
1202890	-1612	16	25,0	1"	12	3/4	41,3	80,3	29,5	6000
1200220	-1616	16	25,0	1"	16	1	47,6	94,8	35,0	6000
1200221	-1620	16	25,0	1"	20	1 1/4	54,0	105,3	44,0	6000
1201557	-2016	20	32,0	1 1/4"	16	1	47,6	104,7	34,5	6000
1200242	-2020	20	32,0	1 1/4"	20	1 1/4	54,0	102,0	39,5	6000
1200241	-2024	20	32,0	1 1/4"	24	1 1/2	63,5	111,7	48,0	6000
1200264	-2424	24	38,0	1 1/2"	24	1 1/2	63,5	136,3	48,0	6000
1200265	-2432	24	38,0	1 1/2"	32	2	79,4	129,1	55,0	6000
1200282	-3232	32	51,0	2"	32	2	79,4	160,6	63,0	6000

**// H1443690**

**90° Flange SAE 6000 PSI J518 Code 62 - SFS 90**  
**Solid one piece**

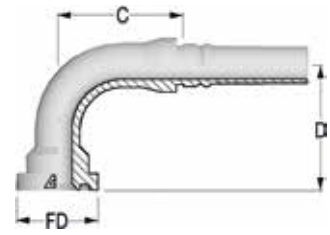

Item Code	Tale/Head		ID		Flange		Flange Size	FD	C	D Drop	WP
	Dash	Dash	mm	in	Dash Size	Dash Size					
1200197	-1212	12	19,0	3/4"	12	3/4	41,3	61,2	64,0	6000	
1200196	-1216	12	19,0	3/4"	16	1	47,6	61,2	66,0	6000	
1202811	-1612	16	25,0	1"	12	3/4	41,3	70,2	61,0	6000	
1200222	-1616	16	25,0	1"	16	1	47,6	70,4	74,0	6000	
1200223	-1620	16	25,0	1"	20	1 1/4	54,0	77,2	80,0	6000	
1200244	-2020	20	32,0	1 1/4"	20	1 1/4	54,0	88,2	91,0	6000	
1200243	-2024	20	32,0	1 1/4"	24	1 1/2	63,5	92,9	103,5	6000	
1200266	-2424	24	38,0	1 1/2"	24	1 1/2	63,5	106,3	109,0	6000	
1200267	-2432	24	38,0	1 1/2"	32	2	79,4	106,5	121,5	6000	
1200283	-3232	32	51,0	2"	32	2	79,4	146,0	138,5	6000	

Dimensions shown may be changed without prior notice

**// H1T43610**

**Flange SAE 6000 PSI J518 Code 62 - SFS  
Special version**

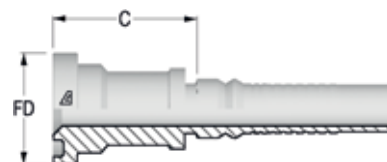

Item Code	Tale/Head	ID			Flange	Flange Size	C	FD	WP
	Dash	Dash	mm	in	Dash Size		mm	mm	psi
1223166	-3224	32	51,0	2"	24	1 1/2	106,0	63,5	6000
1223388	-3232	32	51,0	2"	32	2	104,0	79,4	6000
1235395	-4040	40	63,0	2 1/2"	40	2 1/2	124,3	108,0	6000

**// H1T43640**

**45° Flange SAE 6000 PSI J518 Code 62 - SFS 45  
Solid one piece  
Special version**

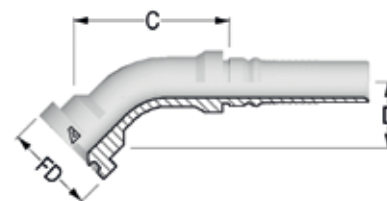

Item Code	Tale/Head	ID			Flange	Flange Size	FD	C	D Drop	WP
	Dash	Dash	mm	in	Dash Size		mm	mm	mm	psi
1223389	-3232	32	51,0	2"	32	2	79,4	141,0	63,0	6000

**// H1T43690**

**90° Flange SAE 6000 PSI J518 Code 62 - SFS 90  
Solid one piece  
Special version**

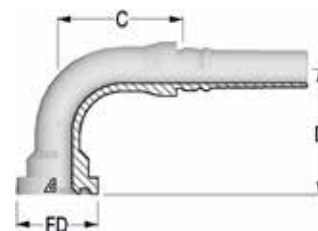

Item Code	Tale/Head	ID			Flange	Flange Size	FD	C	D Drop	WP
	Dash	Dash	mm	in	Dash Size		mm	mm	mm	psi
1223168	-3224	32	51,0	2"	24	1 1/2	63,5	134,0	112,0	6000
1228051	-3232	32	51,0	2"	32	2	79,4	132,0	145,0	6000

# // SUPERCAT FLANGES

## // H1443910

### Flange SUPERCAT

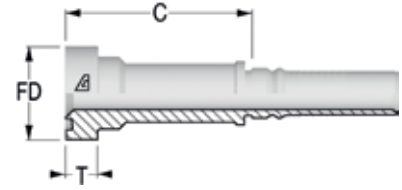

Item Code	Tale/Head	ID		Flange		Flange Size	FD	T	C
	Dash	Dash	mm	in	Dash Size				
1202219	-1212	12	19,0	3/4"	12	3/4	41,3	14,3	82,0
1202388	-1216	12	19,0	3/4"	16	1	47,6	14,3	82,0
1202389	-1616	16	25,0	1"	16	1	47,6	14,3	90,0
1202390	-1620	16	25,0	1"	20	1 1/4	54,0	14,3	90,0
1202391	-2020	20	32,0	1 1/4"	20	1 1/4	54,0	14,3	86,2
1202392	-2024	20	32,0	1 1/4"	24	1 1/2	63,5	14,3	83,2

## // H1443940

### 45° Flange SUPERCAT Solid one piece

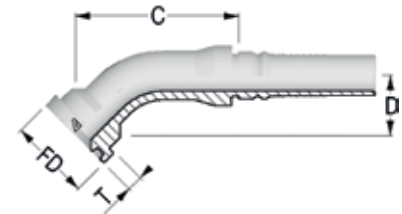

Item Code	Tale/Head	ID		Flange		Flange Size	FD	T	C	D Drop
	Dash	Dash	mm	in	Dash Size					
1202398	-1212	12	19,0	3/4"	12	3/4	41,3	14,3	82,9	34,0
1202397	-1216	12	19,0	3/4"	16	1	47,6	14,3	87,4	34,0
1202396	-1616	16	25,0	1"	16	1	47,6	14,3	93,9	40,0
1202395	-1620	16	25,0	1"	20	1 1/4	54,0	14,3	95,4	40,0
1202394	-2020	20	32,0	1 1/4"	20	1 1/4	54,0	14,3	103,6	43,0
1202393	-2024	20	32,0	1 1/4"	24	1 1/2	63,5	14,3	110,1	49,5

## // H1443990

### 90° Flange SUPERCAT Solid one piece

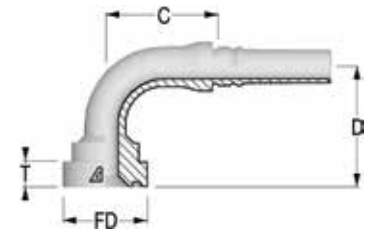

Item Code	Tale/Head	ID		Flange		Flange Size	FD	T	C	D Drop
	Dash	Dash	mm	in	Dash Size					
1202399	-1212	12	19,0	3/4"	12	3/4	41,3	14,3	63,7	67,0
1202400	-1216	12	19,0	3/4"	16	1	47,6	14,3	65,2	70,0
1202401	-1616	16	25,0	1"	16	1	47,6	14,3	80,4	79,0
1202402	-1620	16	25,0	1"	20	1 1/4	54,0	14,3	75,4	82,5
1202403	-2020	20	32,0	1 1/4"	20	1 1/4	54,0	14,3	89,2	93,0
1202404	-2024	20	32,0	1 1/4"	24	1 1/2	63,5	14,3	91,4	101,0

Dimensions shown may be changed without prior notice

## // HAMMER UNION

### // H1413F13

Male Hammer Union Fig. 1502 integral fitting with Lug Nut

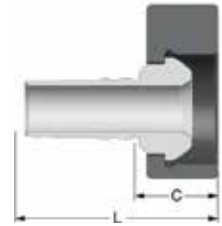

Item Code	Tale/Head	Dash	ID		C	L
	Dash		mm	in	mm	mm
1235621	-3232	32	51,0	2"	55,0	152,00

### // H1423F10

Female Hammer Union Fig. 1502 integral fitting with Rubber Ring

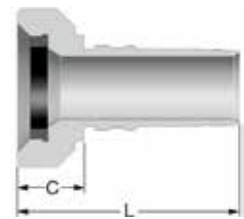

Item Code	Tale/Head	Dash	ID		C	L
	Dash		mm	in	mm	mm
1238273	-3232	32	51,0	2"	51,5	148,50

### // H1T13F13

Male Hammer Union Fig. 1502 integral fitting with Lug Nut Special version

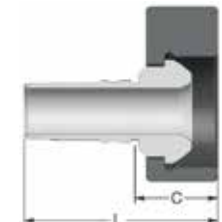

Item Code	Tale/Head	Dash	ID		C	L
	Dash		mm	in	mm	mm
1235624	-3232	32	51,0	2"	60,8	162,20

### // H1T23F10

Female Hammer Union Fig. 1502 integral fitting with Rubber Ring Special version

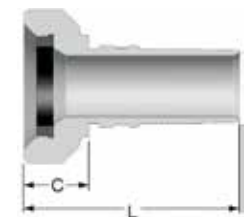

Item Code	Tale/Head	Dash	ID		C	L
	Dash		mm	in	mm	mm
1235623	-3232	32	51,0	2"	57,3	158,70





**// ALFACRIMP // C12A**

// BSP INSERTS .....	137	// NPSM INSERTS .....	155
// DIN METRIC INSERTS .....	141	// ORFS INSERTS .....	156
// SAE INSERTS .....	146	// JIS INSERTS.....	159
// JIC 37° INSERTS.....	148	// KOMATSU INSERTS .....	160
// NPTF INSERTS .....	153	// SAE FLANGES .....	161

Dimensions shown may be changed without prior notice

## // BSP INSERTS

## // C12A10510

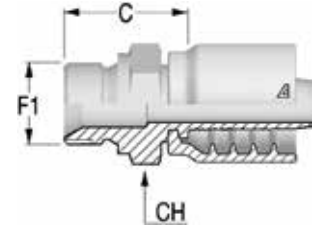
**BSPP Male 60° Flare  
AGR**

Item Code	Tale/Head	Nut Type	ID			F1	F1	C	CH
	Dash		Dash	mm	in	Dash Size			
1232544	-0402	NA	04	6,0	1/4"	02	1/8-28	20,8	14,0
1232545	-0404	NA	04	6,0	1/4"	04	1/4-19	26,3	19,0
1232546	-0406	NA	04	6,0	1/4"	06	3/8-19	27,8	22,0
1232547	-0506	NA	05	8,0	5/16"	06	3/8-19	27,8	22,0
1232548	-0606	NA	06	10,0	3/8"	06	3/8-19	27,8	22,0
1232549	-0608	NA	06	10,0	3/8"	08	1/2-14	31,3	27,0
1232550	-0806	NA	08	13,0	1/2"	06	3/8-19	28,6	22,0
1232551	-0808	NA	08	13,0	1/2"	08	1/2-14	32,1	27,0
1232552	-0810	NA	08	13,0	1/2"	10	5/8-14	34,1	30,0
1232553	-0812	NA	08	13,0	1/2"	12	3/4-14	36,1	32,0
1232554	-1010	NA	10	16,0	5/8"	10	5/8-14	34,1	30,0
1232555	-1012	NA	10	16,0	5/8"	12	3/4-14	36,1	32,0
1232556	-1212	NA	12	19,0	3/4"	12	3/4-14	36,6	32,0
1232557	-1216	NA	12	19,0	3/4"	16	1-11	41,6	41,0
1232558	-1616	NA	16	25,0	1"	16	1-11	42,4	41,0
1232559	-1620	NA	16	25,0	1"	20	1 1/4-11	46,4	50,0

## // C12A10710

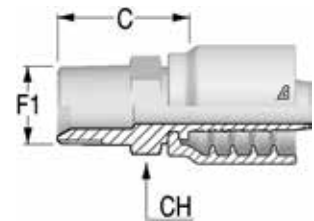
**BSPT Male  
AGR K**

Item Code	Tale/Head	Nut Type	ID			F1	F1	C	CH
	Dash		Dash	mm	in	Dash Size			
1232560	-0402	NA	04	6,0	1/4"	02	1/8-28	21,3	12,0
1232561	-0404	NA	04	6,0	1/4"	04	1/4-19	26,8	17,0
1232562	-0406	NA	04	6,0	1/4"	06	3/8-19	27,8	19,0
1232563	-0506	NA	05	8,0	5/16"	06	3/8-19	27,8	19,0
1232564	-0606	NA	06	10,0	3/8"	06	3/8-19	27,8	19,0
1232565	-0608	NA	06	10,0	3/8"	08	1/2-14	32,3	22,0
1232566	-0808	NA	08	13,0	1/2"	08	1/2-14	33,1	22,0
1232567	-1012	NA	10	16,0	5/8"	12	3/4-14	34,1	27,0
1232568	-1212	NA	12	19,0	3/4"	12	3/4-14	34,6	27,0
1232569	-1216	NA	12	19,0	3/4"	16	1-11	43,6	36,0
1232570	-1616	NA	16	25,0	1"	16	1-11	44,4	36,0

## // C12A20813

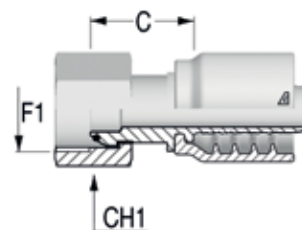
**BSP Female 60° Cone with O-Ring  
DKOR**

Item Code	Tale/Head Dash	Nut Type	ID			F1		F1	C	CH1
			Dash	mm	in	Dash Size	mm			
1232679	-0404	SN	04	6,0	1/4"	04	1/4-19	20,8	19,0	
1232680	-0406	SN	04	6,0	1/4"	06	3/8-19	23,3	22,0	
1232681	-0506	SN	05	8,0	5/16"	06	3/8-19	23,3	22,0	
1232675	-0604	CR	06	10,0	3/8"	04	1/4-19	17,3	19,0	
1232682	-0606	SN	06	10,0	3/8"	06	3/8-19	23,3	22,0	
1232683	-0608	SN	06	10,0	3/8"	08	1/2-14	24,3	27,0	
1232684	-0808	SN	08	13,0	1/2"	08	1/2-14	25,1	27,0	
1232685	-0810	SN	08	13,0	1/2"	10	5/8-14	28,4	27,0	
1232686	-0812	SN	08	13,0	1/2"	12	3/4-14	29,0	32,0	
1232676	-1010	CR	10	16,0	5/8"	10	5/8-14	17,1	27,0	
1232687	-1012	SN	10	16,0	5/8"	12	3/4-14	29,0	32,0	
1232677	-1212	CR	12	19,0	3/4"	12	3/4-14	20,6	32,0	
1232688	-1216	SN	12	19,0	3/4"	16	1-11	34,0	38,0	
1232678	-1616	CR	16	25,0	1"	16	1-11	23,9	38,0	
1232689	-1620	SN	16	25,0	1"	20	1 1/4-11	39,4	50,0	

## // C12A20843

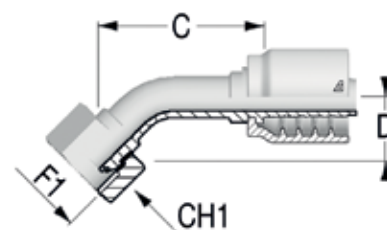
**45° BSP Female 60° Cone with O-Ring  
DKOR 45  
Solid one piece**

Item Code	Tale/Head Dash	Nut Type	ID			F1		C	D Drop	CH1
			Dash	mm	in	Dash Size	mm			
1232693	-0404	SN	04	6,0	1/4"	04	1/4-19	45,5	15,0	19,0
1232694	-0406	SN	04	6,0	1/4"	06	3/8-19	41,5	17,5	22,0
1232695	-0506	SN	05	8,0	5/16"	06	3/8-19	45,1	18,5	22,0
1232696	-0606	SN	06	10,0	3/8"	06	3/8-19	49,9	20,5	22,0
1232697	-0608	SN	06	10,0	3/8"	08	1/2-14	45,7	21,0	27,0
1232698	-0808	SN	08	13,0	1/2"	08	1/2-14	55,0	21,0	27,0
1232699	-0810	SN	08	13,0	1/2"	10	5/8-14	57,2	23,0	27,0
1232700	-0812	SN	08	13,0	1/2"	12	3/4-14	56,7	23,0	32,0
1232690	-1010	CR	10	16,0	5/8"	10	5/8-14	64,0	21,5	27,0
1232701	-1012	SN	10	16,0	5/8"	12	3/4-14	66,5	22,5	32,0
1232691	-1212	CR	12	19,0	3/4"	12	3/4-14	70,0	28,0	32,0
1232702	-1216	SN	12	19,0	3/4"	16	1-11	74,6	31,5	38,0
1232692	-1616	CR	16	25,0	1"	16	1-11	84,0	34,0	38,0

Dimensions shown may be changed without prior notice

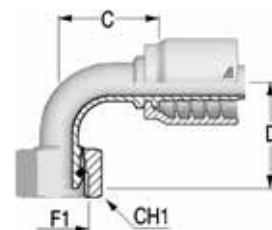
**// C12A20893****90° BSPP Female 60° Cone with O-Ring****DKOR 90****Solid one piece**

Item Code	Tale/Head Dash	Nut Type	ID		F1		F1	C	D Drop	CH1
			Dash	mm	in	Dash Size				
1232706	-0404	SN	04	6,0	1/4"	04	1/4-19	29,3	29,0	19,0
1232707	-0406	SN	04	6,0	1/4"	06	3/8-19	29,8	31,0	22,0
1232708	-0506	SN	05	8,0	5/16"	06	3/8-19	33,2	36,0	22,0
1232709	-0606	SN	06	10,0	3/8"	06	3/8-19	34,8	42,0	22,0
1232710	-0608	SN	06	10,0	3/8"	08	1/2-14	34,3	35,5	27,0
1232711	-0808	SN	08	13,0	1/2"	08	1/2-14	35,8	41,0	27,0
1232712	-0810	SN	08	13,0	1/2"	10	5/8-14	41,6	43,5	27,0
1232713	-0812	SN	08	13,0	1/2"	12	3/4-14	41,8	43,0	32,0
1232703	-1010	CR	10	16,0	5/8"	10	5/8-14	47,9	47,0	27,0
1232714	-1012	SN	10	16,0	5/8"	12	3/4-14	51,9	49,0	32,0
1232704	-1212	CR	12	19,0	3/4"	12	3/4-14	49,1	53,0	32,0
1232715	-1216	SN	12	19,0	3/4"	16	1-11	54,1	60,5	38,0
1232705	-1616	CR	16	25,0	1"	16	1-11	75,1	69,0	38,0
1232716	-1620	SN	16	25,0	1"	20	1 1/4-11	75,1	88,5	50,0

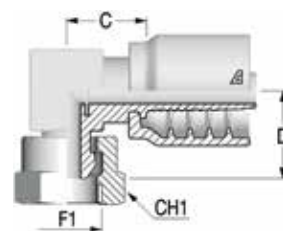
**// C12A20581****90° Compact BSPP Female 60° Cone****DKR 90**

Item Code	Tale/Head Dash	Nut Type	ID		F1		F1	C	D Drop	CH1
			Dash	mm	in	Dash Size				
1232668	-0606	CR	06	10,0	3/8"	06	3/8-19	18,8	22,0	22,0
1232669	-0808	CR	08	13,0	1/2"	08	1/2-14	22,6	24,5	27,0
1232670	-1212	CR	12	19,0	3/4"	12	3/4-14	26,7	31,0	32,0

**// C12A20613**

**BSP Female Flat Seat  
DKR FD**

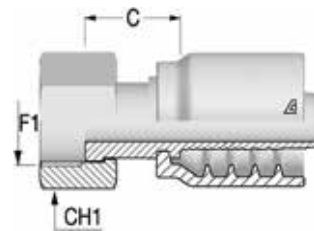

Item Code	Tale/Head	Nut Type	ID			F1	F1	C	CH1
	Dash		Dash	mm	in	Dash Size			
1232672	-0606	SN	06	10,0	3/8"	06	3/8-19	20,3	22,0
1232673	-0608	SN	06	10,0	3/8"	08	1/2-14	20,8	27,0
1232674	-0808	SN	08	13,0	1/2"	08	1/2-14	21,6	27,0
1232671	-1212	CR	12	19,0	3/4"	12	3/4-14	18,1	32,0

Dimensions shown may be changed without prior notice

## // DIN METRIC INSERTS

## // C12A11110

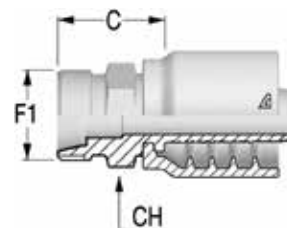
Metric Male 24° Seat - Light  
DIN 3853 - CEL

Item Code	Tale/Head Dash/mm	Nut Type	ID			F1	OD1 mm	C mm	CH mm
			Dash	mm	in				
1232571	-0412	NA	04	6,0	1/4"	M12X1.5	6	21,3	14,0
1232572	-0414	NA	04	6,0	1/4"	M14X1.5	8	21,3	14,0
1232573	-0416	NA	04	6,0	1/4"	M16X1.5	10	23,3	17,0
1232574	-0516	NA	05	8,0	5/16"	M16X1.5	10	23,3	17,0
1232575	-0518	NA	05	8,0	5/16"	M18X1.5	12	24,3	19,0
1232576	-0616	NA	06	10,0	3/8"	M16X1.5	10	23,3	17,0
1232577	-0618	NA	06	10,0	3/8"	M18X1.5	12	24,3	19,0
1232578	-0622	NA	06	10,0	3/8"	M22X1.5	15	25,3	22,0
1232579	-0822	NA	08	13,0	1/2"	M22X1.5	15	26,1	22,0
1232580	-0826	NA	08	13,0	1/2"	M26X1.5	18	27,1	27,0
1232581	-1026	NA	10	16,0	5/8"	M26X1.5	18	27,1	27,0
1232582	-1230	NA	12	19,0	3/4"	M30X2	22	31,6	32,0
1232583	-1636	NA	16	25,0	1"	M36X2	28	34,4	36,0

## // C12A21513

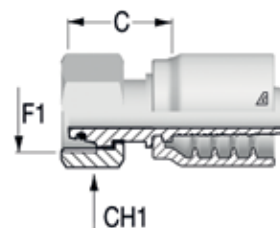
Metric Female 24° Cone with O-Ring - Light  
DIN 3865 - DKOL

Item Code	Tale/Head Dash/mm	Nut Type	ID			F1	OD1 mm	C mm	CH1 mm
			Dash	mm	in				
1232717	-0412	CR	04	6,0	1/4"	M12X1.5	6	24,8	14,0
1232718	-0414	SN	04	6,0	1/4"	M14X1.5	8	24,4	17,0
1232719	-0416	SN	04	6,0	1/4"	M16X1.5	10	25,4	19,0
1232720	-0516	SN	05	8,0	5/16"	M16X1.5	10	25,4	19,0
1232721	-0616	SN	06	10,0	3/8"	M16X1.5	10	25,4	19,0
1232722	-0618	SN	06	10,0	3/8"	M18X1.5	12	25,4	22,0
1232723	-0622	SN	06	10,0	3/8"	M22X1.5	15	27,4	27,0
1232724	-0822	SN	08	13,0	1/2"	M22X1.5	15	28,2	27,0
1232725	-0826	SN	08	13,0	1/2"	M26X1.5	18	29,2	32,0
1232726	-1026	SN	10	16,0	5/8"	M26X1.5	18	29,2	32,0
1232727	-1230	SN	12	19,0	3/4"	M30X2	22	31,7	36,0
1232728	-1636	SN	16	25,0	1"	M36X2	28	33,6	41,0

## // C12A21543

**45° Metric Female 24° Cone with O-Ring - Light**  
**DIN 3865 - DKOL 45**  
**Solid one piece**

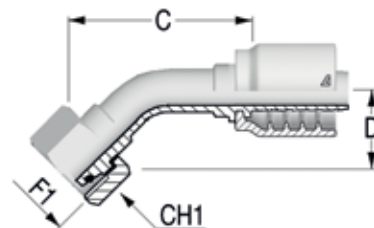

Item Code	Tale/Head Dash/mm	Nut Type	ID			F1	OD1 mm	C mm	D Drop mm	CH1 mm
			Dash	mm	in					
1232729	-0414	SN	04	6,0	1/4"	M14X1.5	8	43,0	17,5	17,0
1232730	-0416	SN	04	6,0	1/4"	M16X1.5	10	42,0	20,0	19,0
1232731	-0516	SN	05	8,0	5/16"	M16X1.5	10	47,5	20,0	19,0
1232733	-0618	SN	06	10,0	3/8"	M18X1.5	12	46,8	19,5	22,0
1232734	-0822	SN	08	13,0	1/2"	M22X1.5	15	55,0	21,0	22,0
1232735	-1026	SN	10	16,0	5/8"	M26X1.5	18	65,3	24,0	32,0
1232736	-1230	SN	12	19,0	3/4"	M30X2	22	69,4	32,0	36,0
1232737	-1636	SN	16	25,0	1"	M36X2	28	91,4	32,0	41,0

## // C12A21593

**90° Metric Female 24° Cone with O-Ring - Light**  
**DIN 3865 - DKOL 90**  
**Solid one piece**

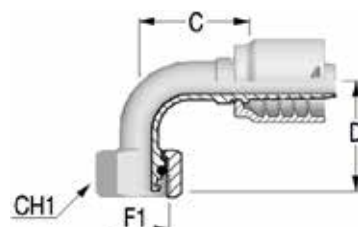

Item Code	Tale/Head Dash/mm	Nut Type	ID			F1	OD1 mm	C mm	D Drop mm	CH1 mm
			Dash	mm	in					
1232738	-0412	CR	04	6,0	1/4"	M12X1.5	6	29,5	26,0	14,0
1232739	-0414	SN	04	6,0	1/4"	M14X1.5	8	28,3	32,5	17,0
1232740	-0416	SN	04	6,0	1/4"	M16X1.5	10	28,3	32,5	19,0
1232741	-0418	SN	04	6,0	1/4"	M18X1.5	12	28,8	35,0	22,0
1232742	-0516	SN	05	8,0	5/16"	M16X1.5	10	33,7	38,0	19,0
1232743	-0616	SN	06	10,0	3/8"	M16X1.5	10	32,8	38,0	19,0
1232744	-0618	SN	06	10,0	3/8"	M18X1.5	12	32,8	39,0	22,0
1232745	-0822	SN	08	13,0	1/2"	M22X1.5	15	39,8	40,5	27,0
1232746	-1026	SN	10	16,0	5/8"	M26X1.5	18	51,4	48,0	32,0
1232747	-1030	SN	10	16,0	5/8"	M30X2	22	52,4	49,0	36,0
1232748	-1230	SN	12	19,0	3/4"	M30X2	22	52,1	59,0	36,0
1232749	-1636	SN	16	25,0	1"	M36X2	28	77,6	68,0	41,0

Dimensions shown may be changed without prior notice

## // C12A11210

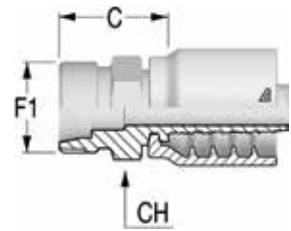
**Metric Male 24° Seat - Heavy  
DIN 3853 - CES**

Item Code	Tale/Head Dash/mm	Nut Type	ID			F1	OD1 mm	C mm	CH mm
			Dash	mm	in				
1232584	-0418	NA	04	6,0	1/4"	M18X1.5	10	25,3	19,0
1232585	-0520	NA	05	8,0	5/16"	M20X1.5	12	25,3	22,0
1232586	-0620	NA	06	10,0	3/8"	M20X1.5	12	25,3	22,0
1232587	-0622	NA	06	10,0	3/8"	M22X1.5	14	27,3	22,0
1232588	-0824	NA	08	13,0	1/2"	M24X1.5	16	29,1	24,0
1232589	-1030	NA	10	16,0	5/8"	M30X2	20	33,1	32,0
1232590	-1230	NA	12	19,0	3/4"	M30X2	20	33,6	32,0
1232591	-1236	NA	12	19,0	3/4"	M36X2	25	37,6	36,0
1232592	-1642	NA	16	25,0	1"	M42X2	30	42,4	46,0

## // C12A21613

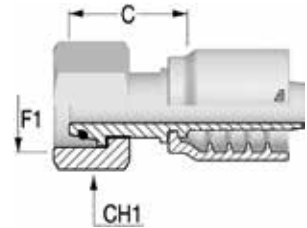
**Metric Female 24° Cone with O-Ring - Heavy  
DIN 3865 - DKOS**

Item Code	Tale/Head Dash/mm	Nut Type	ID			F1	OD1 mm	C mm	CH1 mm
			Dash	mm	in				
1232750	-0416	SN	04	6,0	1/4"	M16X1.5	8	27,7	19,0
1232751	-0418	SN	04	6,0	1/4"	M18X1.5	10	27,6	22,0
1232752	-0520	SN	05	8,0	5/16"	M20X1.5	12	27,6	24,0
1232753	-0618	SN	06	10,0	3/8"	M18X1.5	10	27,6	22,0
1232754	-0620	SN	06	10,0	3/8"	M20X1.5	12	27,6	24,0
1232755	-0622	SN	06	10,0	3/8"	M22X1.5	14	31,1	27,0
1232756	-0820	SN	08	13,0	1/2"	M20X1.5	12	31,9	24,0
1232757	-0824	SN	08	13,0	1/2"	M24X1.5	16	31,7	30,0
1232758	-1030	SN	10	16,0	5/8"	M30X2	20	36,5	36,0
1232759	-1230	SN	12	19,0	3/4"	M30X2	20	37,0	36,0
1232760	-1236	SN	12	19,0	3/4"	M36X2	25	40,2	46,0
1232761	-1636	SN	16	25,0	1"	M36X2	25	41,0	46,0
1232762	-1642	SN	16	25,0	1"	M42X2	30	43,1	50,0



## // C12A21643

**45° Metric Female 24° Cone with O-Ring - Heavy**  
**DIN 3865 - DKOS 45**  
**Solid one piece**

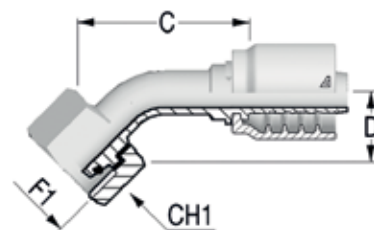

Item Code	Tale/Head Dash/mm	Nut Type	ID			F1	OD1 mm	C mm	D Drop mm	CH1 mm
			Dash	mm	in					
1232763	-0416	SN	04	6,0	1/4"	M16X1.5	8	48,6	16,0	19,0
1232764	-0418	SN	04	6,0	1/4"	M18X1.5	10	43,5	19,0	22,0
1232765	-0520	SN	05	8,0	5/16"	M20X1.5	12	48,1	21,0	24,0
1232766	-0620	SN	06	10,0	3/8"	M20X1.5	12	50,6	20,0	24,0
1232767	-0622	SN	06	10,0	3/8"	M22X1.5	14	52,9	21,0	27,0
1232768	-0824	SN	08	13,0	1/2"	M24X1.5	16	55,8	21,5	30,0
1232769	-1030	SN	10	16,0	5/8"	M30X2	20	66,3	30,0	36,0
1232770	-1236	SN	12	19,0	3/4"	M36X2	25	69,5	33,0	46,0
1232771	-1642	SN	16	25,0	1"	M42X2	30	110,3	40,5	50,0

## // C12A21693

**90° Metric Female 24° Cone with O-Ring - Heavy**  
**DIN 3865 - DKOS 90**  
**Solid one piece**

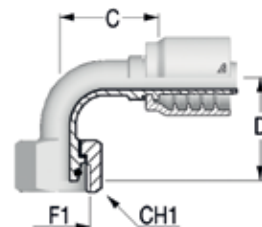

Item Code	Tale/Head Dash/mm	Nut Type	ID			F1	OD1 mm	C mm	D Drop mm	CH1 mm
			Dash	mm	in					
1232772	-0416	SN	04	6,0	1/4"	M16X1.5	8	27,3	33,0	19,0
1232773	-0418	SN	04	6,0	1/4"	M18X1.5	10	26,8	34,0	22,0
1232774	-0520	SN	05	8,0	5/16"	M20X1.5	12	33,2	39,0	24,0
1232775	-0618	TN	06	10,0	3/8"	M18X1.5	10	35,0	38,0	22,0
1232776	-0620	SN	06	10,0	3/8"	M20X1.5	12	34,3	38,5	24,0
1232777	-0622	SN	06	10,0	3/8"	M22X1.5	14	34,3	40,5	27,0
1232778	-0824	SN	08	13,0	1/2"	M24X1.5	16	39,8	41,5	30,0
1232779	-1030	SN	10	16,0	5/8"	M30X2	20	47,9	55,0	36,0
1232780	-1230	SN	12	19,0	3/4"	M30X2	20	50,6	58,0	36,0
1232781	-1236	SN	12	19,0	3/4"	M36X2	25	50,6	59,5	46,0
1232782	-1642	SN	16	25,0	1"	M42X2	30	75,6	79,0	50,0

Dimensions shown may be changed without prior notice

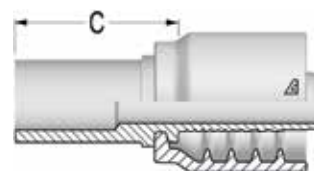
**// C12A52010****Metric Straight Standpipe - DIN 2353  
RSL/RSS**

Item Code	Tale/Head	Dash	ID		OD1	C
	Dash/mm		mm	in		
1233002	-0408	04	6,0	1/4"	8	30,2
1233003	-0610	06	10,0	3/8"	10	30,3
1233004	-0815	08	13,0	1/2"	15	32,1
1233005	-0816	08	13,0	1/2"	16	37,1

## // SAE INSERTS

### // C12A13B10

SAE Male Flareless

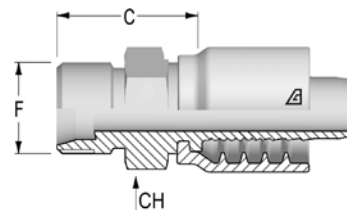

Item Code	Tale/Head Dash	Nut Type	ID			F1		C mm	CH mm
			Dash	mm	in	Dash Size	F1		
1240072	-0404	NA	04	6,0	1/4"	04	7/16-20	21,8	12,0
1242131	-0506	NA	05	8,0	5/16"	06	9/16-18	24,2	16,0
1239967	-0606	NA	06	10,0	3/8"	06	9/16-18	24,2	16,0
1242132	-0608	NA	06	10,0	3/8"	08	3/4-16	27,6	22,0
1237777	-0808	NA	08	13,0	1/2"	08	3/4-16	28,4	22,0
1242133	-1212	NA	12	19,0	3/4"	12	1 1/16-12	33,1	30,0
1242135	-1616	NA	16	25,0	1"	16	-	37,9	36,0

### // C12A26611

SAE Female Swivel 45° Seat

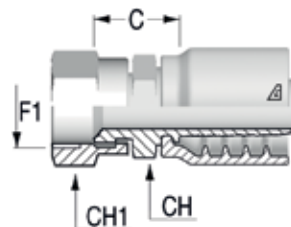

Item Code	Tale/Head Dash	Nut Type	ID			F1		C mm	CH mm	CH1 mm
			Dash	mm	in	Dash Size	F1			
1232955	-0606	CR	06	10,0	3/8"	06	5/8-18	23,3	19,0	22,0
1232956	-1212	CR	12	19,0	3/4"	12	1 1/16-14	28,6	27,0	32,0

Dimensions shown may be changed without prior notice

## // C12A13010

### SAE Male Solid O-Ring Boss

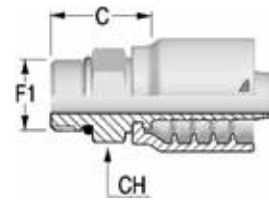

Item Code	Tale/Head Dash	Nut Type	ID		F1		F1	C	CH
			Dash	mm	in	Dash Size			
1232654	-0404	NA	04	6,0	1/4"	04	7/16-20	20,3	14,0
1232655	-0405	NA	04	6,0	1/4"	05	1/2-20	21,3	16,0
1232656	-0406	NA	04	6,0	1/4"	06	9/16-18	22,3	17,0
1232657	-0606	NA	06	10,0	3/8"	06	9/16-18	23,3	19,0
1232658	-0608	NA	06	10,0	3/8"	08	3/4-16	24,3	22,0
1232659	-0610	NA	06	10,0	3/8"	10	7/8-14	26,8	27,0
1232660	-0808	NA	08	13,0	1/2"	08	3/4-16	25,1	22,0
1232661	-0810	NA	08	13,0	1/2"	10	7/8-14	27,6	27,0
1232662	-0812	NA	08	13,0	1/2"	12	1 1/16-12	32,1	32,0
1232663	-1012	NA	10	16,0	5/8"	12	1 1/16-12	32,1	32,0
1232664	-1210	NA	12	19,0	3/4"	10	7/8-14	28,1	27,0
1232665	-1212	NA	12	19,0	3/4"	12	1 1/16-12	32,6	32,0
1232666	-1216	NA	12	19,0	3/4"	16	1 5/16-12	34,6	38,0
1232667	-1616	NA	16	25,0	1"	16	1 5/16-12	35,4	38,0

## // C12A13081

### 90° Compact SAE Male Swivel O-Ring Boss

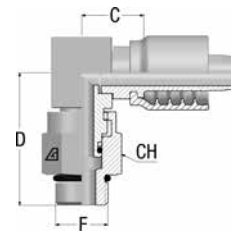

Item Code	Tale/Head Dash	Nut Type	ID		F1		F1	C	D Drop	CH
			Dash	mm	in	Dash Size				
1240611	-0404	CR	04	6,0	1/4"	04	7/16-20	17,0	35,0	17,0
1240612	-0405	CR	04	6,0	1/4"	05	1/2-20	17,0	35,0	17,0
1240613	-0406	CR	04	6,0	1/4"	06	9/16-18	19,0	42,0	22,0
1240614	-0606	CR	06	10,0	3/8"	06	9/16-18	20,0	44,0	22,0
1240615	-0608	CR	06	10,0	3/8"	08	3/4-16	22,0	45,0	25,0
1240616	-0808	CR	08	13,0	1/2"	08	3/4-16	23,0	48,0	25,0
1240001	-0810	CR	08	13,0	1/2"	10	7/8-14	23,0	50,0	25,0
1240617	-1212	CR	12	19,0	3/4"	12	1 1/16-12	27,0	60,0	32,0
1240618	-1616	CR	16	25,0	1"	16	1 5/16-12	33,4	67,5	41,0

147

## // JIC 37° INSERTS

## // C12A12510

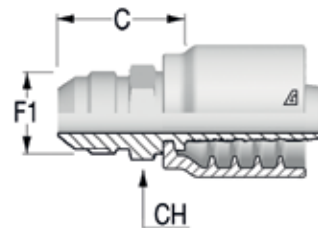
JIC Male 37° Cone  
AGJ

Item Code	Tale/Head	Nut Type	ID			F1	F1	C	CH
	Dash		Dash	mm	in	Dash Size		mm	mm
1232606	-0404	NA	04	6,0	1/4"	04	7/16-20	25,3	12,0
1232607	-0405	NA	04	6,0	1/4"	05	1/2-20	25,3	14,0
1232608	-0406	NA	04	6,0	1/4"	06	9/16-18	26,3	17,0
1232609	-0505	NA	05	8,0	5/16"	05	1/2-20	25,3	14,0
1232610	-0506	NA	05	8,0	5/16"	06	9/16-18	26,3	17,0
1232611	-0606	NA	06	10,0	3/8"	06	9/16-18	26,3	17,0
1232612	-0608	NA	06	10,0	3/8"	08	3/4-16	29,8	19,0
1232613	-0610	NA	06	10,0	3/8"	10	7/8-14	33,8	24,0
1232614	-0808	NA	08	13,0	1/2"	08	3/4-16	30,6	19,0
1232615	-0810	NA	08	13,0	1/2"	10	7/8-14	34,6	24,0
1232616	-0812	NA	08	13,0	1/2"	12	1 1/16-12	37,1	27,0
1232617	-1010	NA	10	16,0	5/8"	10	7/8-14	34,6	24,0
1232618	-1012	NA	10	16,0	5/8"	12	1 1/16-12	37,1	27,0
1232619	-1212	NA	12	19,0	3/4"	12	1 1/16-12	37,6	27,0
1232620	-1214	NA	12	19,0	3/4"	14	1 3/16-12	40,1	32,0
1232621	-1216	NA	12	19,0	3/4"	16	1 5/16-12	42,6	36,0
1232622	-1616	NA	16	25,0	1"	16	1 5/16-12	43,4	36,0
1232623	-1620	NA	16	25,0	1"	20	1 5/8-12	46,9	46,0

Dimensions shown may be changed without prior notice

## // C12A22511

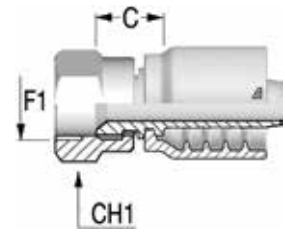
**JIC Female 37° Seat  
DKJ**

Item Code	Tale/Head Dash	Nut Type	ID		F1		F1	C	CH1
			Dash	mm	in	Dash Size			
1232848	-0404	CR	04	6,0	1/4"	04	7/16-20	14,6	16,0
1232849	-0405	CR	04	6,0	1/4"	05	1/2-20	15,3	17,0
1232850	-0406	CR	04	6,0	1/4"	06	9/16-18	15,3	19,0
1232851	-0505	CR	05	8,0	5/16"	05	1/2-20	15,3	17,0
1232852	-0506	CR	05	8,0	5/16"	06	9/16-18	15,3	19,0
1232853	-0606	CR	06	10,0	3/8"	06	9/16-18	15,3	19,0
1232854	-0608	CR	06	10,0	3/8"	08	3/4-16	17,8	25,0
1232855	-0808	CR	08	13,0	1/2"	08	3/4-16	18,6	25,0
1232856	-0810	CR	08	13,0	1/2"	10	7/8-14	19,6	27,0
1232857	-0812	CR	08	13,0	1/2"	12	1 1/16-12	22,1	32,0
1232858	-1010	CR	10	16,0	5/8"	10	7/8-14	19,6	27,0
1232859	-1012	CR	10	16,0	5/8"	12	1 1/16-12	20,1	32,0
1232860	-1210	CR	12	19,0	3/4"	10	7/8-14	20,1	27,0
1232861	-1212	CR	12	19,0	3/4"	12	1 1/16-12	20,6	32,0
1232862	-1214	CR	12	19,0	3/4"	14	1 3/16-12	19,9	36,0
1232863	-1216	CR	12	19,0	3/4"	16	1 5/16-12	22,1	38,0
1232864	-1616	CR	16	25,0	1"	16	1 5/16-12	23,9	38,0
1232865	-1620	TN	16	25,0	1"	20	1 5/8-12	26,5	50,0

**// C12A26511**

**JIC Female 37° Seat with Stem Hexagon  
DKJ**

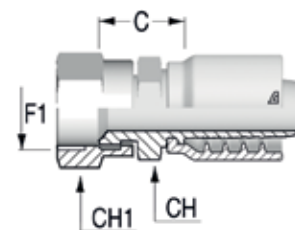

Item Code	Tale/Head Dash	Nut Type	ID			F1		F1	C	CH	CH1
			Dash	mm	in	Dash Size	mm				
1232933	-0404	CR	04	6,0	1/4"	04	7/16-20	19,6	14,0	16,0	
1232934	-0405	CR	04	6,0	1/4"	05	1/2-20	20,3	14,0	17,0	
1232935	-0406	CR	04	6,0	1/4"	06	9/16-18	20,3	14,0	19,0	
1232936	-0506	CR	05	8,0	5/16"	06	9/16-18	20,3	14,0	19,0	
1232937	-0604	CR	06	10,0	3/8"	04	7/16-20	20,6	17,0	16,0	
1232938	-0606	CR	06	10,0	3/8"	06	9/16-18	21,3	17,0	19,0	
1232939	-0608	CR	06	10,0	3/8"	08	3/4-16	24,8	19,0	25,0	
1232940	-0610	CR	06	10,0	3/8"	10	7/8-14	25,8	22,0	27,0	
1232941	-0806	CR	08	13,0	1/2"	06	9/16-18	23,1	19,0	19,0	
1232942	-0808	CR	08	13,0	1/2"	08	3/4-16	25,6	19,0	25,0	
1232943	-0810	CR	08	13,0	1/2"	10	7/8-14	26,6	22,0	27,0	
1232944	-0812	CR	08	13,0	1/2"	12	1 1/16-12	28,1	25,0	32,0	
1232945	-1008	CR	10	16,0	5/8"	08	3/4-16	26,6	24,0	25,0	
1232946	-1010	CR	10	16,0	5/8"	10	7/8-14	27,6	24,0	27,0	
1232947	-1012	CR	10	16,0	5/8"	12	1 1/16-12	28,1	25,0	32,0	
1232948	-1210	CR	12	19,0	3/4"	10	7/8-14	28,1	27,0	27,0	
1232949	-1212	CR	12	19,0	3/4"	12	1 1/16-12	28,6	27,0	32,0	
1232950	-1214	CR	12	19,0	3/4"	14	1 3/16-12	29,9	32,0	36,0	
1232951	-1216	CR	12	19,0	3/4"	16	1 5/16-12	32,1	32,0	38,0	
1232952	-1612	CR	16	25,0	1"	12	1 1/16-12	31,4	32,0	32,0	
1232953	-1616	CR	16	25,0	1"	16	1 5/16-12	32,9	32,0	38,0	
1232954	-1620	TN	16	25,0	1"	20	1 5/8-12	37,5	41,0	50,0	

**// C12A22541-M**

**45° JIC Female 37° Seat - Medium Drop  
DKJ 45M  
Solid one piece**

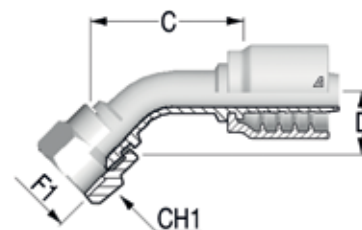

Item Code	Tale/Head Dash	Nut Type	ID			F1		C	D Drop	CH1
			Dash	mm	in	Dash Size	mm			
1232866	-0404	CR	04	6,0	1/4"	04	7/16-20	36,6	10,0	16,0
1232867	-0405	CR	04	6,0	1/4"	05	1/2-20	37,2	12,0	17,0
1232868	-0406	CR	04	6,0	1/4"	06	9/16-18	39,4	11,0	19,0
1232869	-0506	CR	05	8,0	5/16"	06	9/16-18	42,8	12,0	19,0
1232870	-0606	CR	06	10,0	3/8"	06	9/16-18	46,3	11,0	19,0
1232871	-0608	CR	06	10,0	3/8"	08	3/4-16	47,2	15,0	25,0
1232872	-0808	CR	08	13,0	1/2"	08	3/4-16	51,6	15,0	25,0
1232873	-0810	CR	08	13,0	1/2"	10	7/8-14	50,7	16,0	27,0
1232874	-0812	CR	08	13,0	1/2"	12	1 1/16-12	57,0	21,0	32,0
1232875	-1010	CR	10	16,0	5/8"	10	7/8-14	62,2	19,0	27,0
1232876	-1012	CR	10	16,0	5/8"	12	1 1/16-12	68,6	21,0	32,0
1232877	-1212	CR	12	19,0	3/4"	12	1 1/16-12	67,5	21,0	32,0
1232878	-1216	CR	12	19,0	3/4"	16	1 5/16-12	71,4	26,0	38,0
1232879	-1616	CR	16	25,0	1"	16	1 5/16-12	79,4	24,0	38,0
1232880	-1620	TN	16	25,0	1"	20	1 5/8-12	83,8	37,0	50,0

Dimensions shown may be changed without prior notice

**// C12A22591-S**

**90° JIC Female 37° Seat - Short Drop**  
**DKJ 90S**  
**Solid one piece**

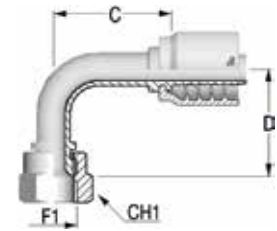

Item Code	Tale/Head Dash	Nut Type	ID			F1		F1	C	D Drop	CH1
			Dash	mm	in	Dash Size	mm				
1232883	-0404	CR	04	6,0	1/4"	04	7/16-20	27,0	21,0	16,0	
1232885	-0405	CR	04	6,0	1/4"	05	1/2-20	26,5	23,5	17,0	
1232887	-0406	CR	04	6,0	1/4"	06	9/16-18	31,0	23,0	19,0	
1232892	-0606	CR	06	10,0	3/8"	06	9/16-18	42,3	23,0	19,0	
1232895	-0608	CR	06	10,0	3/8"	08	3/4-16	48,8	29,0	25,0	
1232898	-0808	CR	08	13,0	1/2"	08	3/4-16	46,4	29,0	25,0	
1232901	-0810	CR	08	13,0	1/2"	10	7/8-14	45,8	32,0	27,0	
1232903	-0812	CR	08	13,0	1/2"	12	1 1/16-12	37,3	46,0	32,0	
1232907	-1012	CR	10	16,0	5/8"	12	1 1/16-12	47,9	48,0	32,0	
1232910	-1212	CR	12	19,0	3/4"	12	1 1/16-12	58,2	46,0	32,0	
1232912	-1216	CR	12	19,0	3/4"	16	1 5/16-12	53,6	53,0	38,0	
1232915	-1616	CR	16	25,0	1"	16	1 5/16-12	74,0	56,0	38,0	

**// C12A22591-M**

**90° JIC Female 37° Seat - Medium Drop**  
**DKJ 90M**  
**Solid one piece**

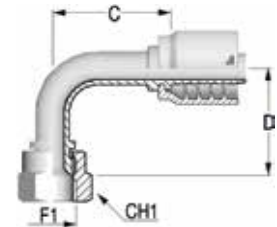

Item Code	Tale/Head Dash	Nut Type	ID			F1		F1	C	D Drop	CH1
			Dash	mm	in	Dash Size	mm				
1232882	-0404	CR	04	6,0	1/4"	04	7/16-20	34,2	32,0	16,0	
1232884	-0405	CR	04	6,0	1/4"	05	1/2-20	25,7	30,0	17,0	
1232886	-0406	CR	04	6,0	1/4"	06	9/16-18	28,5	38,0	19,0	
1232888	-0505	CR	05	8,0	5/16"	05	1/2-20	34,2	32,0	17,0	
1232889	-0506	CR	05	8,0	5/16"	06	9/16-18	33,2	35,0	19,0	
1232891	-0606	CR	06	10,0	3/8"	06	9/16-18	31,3	35,0	19,0	
1232894	-0608	CR	06	10,0	3/8"	08	3/4-16	39,5	41,0	25,0	
1232897	-0808	CR	08	13,0	1/2"	08	3/4-16	37,2	40,0	25,0	
1232900	-0810	CR	08	13,0	1/2"	10	7/8-14	43,3	47,0	27,0	
1232902	-0812	CR	08	13,0	1/2"	12	1 1/16-12	42,8	58,0	32,0	
1232905	-1010	CR	10	16,0	5/8"	10	7/8-14	49,4	48,0	27,0	
1232906	-1012	CR	10	16,0	5/8"	12	1 1/16-12	47,9	58,0	32,0	
1232909	-1212	CR	12	19,0	3/4"	12	1 1/16-12	52,4	54,0	32,0	
1232911	-1216	CR	12	19,0	3/4"	16	1 5/16-12	52,6	72,0	38,0	
1232914	-1616	CR	16	25,0	1"	16	1 5/16-12	72,6	71,5	38,0	
1232916	-1620	TN	16	25,0	1"	20	1 5/8-12	72,6	78,0	50,0	



## // C12A22591-L

90° JIC Female 37° Seat - Long Drop

DKJ 90L

Solid one piece

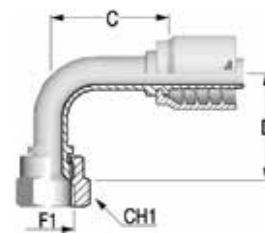

Item Code	Tale/Head Dash	Nut Type	ID		F1		F1	C	D Drop	CH1
			Dash	mm	in	Dash Size				
1232881	-0404	CR	04	6,0	1/4"	04	7/16-20	30,8	46,0	16,0
1232890	-0606	CR	06	10,0	3/8"	06	9/16-18	43,3	54,0	19,0
1232893	-0608	CR	06	10,0	3/8"	08	3/4-16	46,8	64,0	25,0
1232896	-0808	CR	08	13,0	1/2"	08	3/4-16	49,9	64,0	25,0
1232899	-0810	CR	08	13,0	1/2"	10	7/8-14	37,3	65,0	27,0
1232904	-1010	CR	10	16,0	5/8"	10	7/8-14	49,9	65,0	27,0
1232908	-1212	CR	12	19,0	3/4"	12	1 1/16-12	54,1	95,0	32,0
1232913	-1616	CR	16	25,0	1"	16	1 5/16-12	78,6	114,0	38,0

Dimensions shown may be changed without prior notice

## // NPTF INSERTS

## // C12A12810

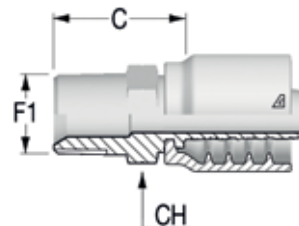
NPTF Male 60° Seat  
AGN

Item Code	Tale/Head	Nut Type	ID			F1	F1	C	CH
	Dash		Dash	mm	in	Dash Size			
1232624	-0402	NA	04	6,0	1/4"	02	1/8-27	21,3	14,0
1232650	-0404	NA	04	6,0	1/4"	04	1/4-18	26,8	27,0
1232625	-0406	NA	04	6,0	1/4"	06	3/8-18	27,8	17,0
1232626	-0408	NA	04	6,0	1/4"	08	1/2-14	31,3	22,0
1232627	-0504	NA	05	8,0	5/16"	04	1/4-18	26,8	19,0
1232628	-0506	NA	05	8,0	5/16"	06	3/8-18	27,8	22,0
1232629	-0604	NA	06	10,0	3/8"	04	1/4-18	26,8	17,0
1232630	-0606	NA	06	10,0	3/8"	06	3/8-18	27,8	19,0
1232631	-0608	NA	06	10,0	3/8"	08	1/2-14	31,3	22,0
1232632	-0806	NA	08	13,0	1/2"	06	3/8-18	28,6	17,0
1232633	-0808	NA	08	13,0	1/2"	08	1/2-14	32,1	19,0
1232634	-0812	NA	08	13,0	1/2"	12	3/4-14	34,1	22,0
1232635	-1008	NA	10	16,0	5/8"	08	1/2-14	33,1	22,0
1232636	-1012	NA	10	16,0	5/8"	12	3/4-14	34,1	25,0
1232637	-1208	NA	12	19,0	3/4"	08	1/2-14	33,6	19,0
1232638	-1212	NA	12	19,0	3/4"	12	3/4-14	34,6	22,0
1232639	-1216	NA	12	19,0	3/4"	16	1-11 1/2	43,6	22,0
1232640	-1616	NA	16	25,0	1"	16	1-11 1/2	44,4	25,0
1232641	-1620	NA	16	25,0	1"	20	1 1/4-11 1/2	47,4	27,0

## // C12A22810

NPTF Female Solid

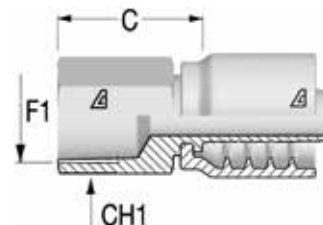

Item Code	Tale/Head	Nut Type	ID			F1	F1	C	CH
	Dash		Dash	mm	in	Dash Size			
1232917	-0404	NA	04	6,0	1/4"	04	1/4-18	27,8	19,0
1232918	-0606	NA	06	10,0	3/8"	06	3/8-18	28,8	22,0
1232919	-0808	NA	08	13,0	1/2"	08	1/2-14	35,6	25,0
1232920	-1212	NA	12	19,0	3/4"	12	3/4-14	38,1	32,0
1232921	-1616	NA	16	25,0	1"	16	1-11 1/2	44,9	38,0

**// C12A12811**  
**NPTF Male Swivel 60° Seat**

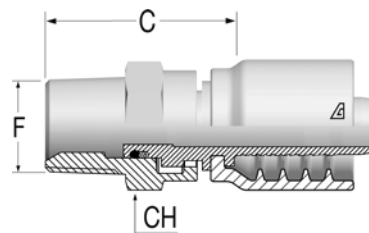

Item Code	Tale/Head Dash	Nut Type	ID			F1		F1	C	CH
			Dash	mm	in	Dash Size	mm			
1232642	-0404	NA	04	6,0	1/4"	04	1/4-18	37,6	24,0	
1232643	-0604	NA	06	10,0	3/8"	04	1/4-18	39,6	27,0	
1232644	-0606	NA	06	10,0	3/8"	06	3/8-18	37,5	27,0	
1232645	-0608	CR	06	10,0	3/8"	08	1/2-14	43,5	32,0	
1232646	-0806	NA	08	13,0	1/2"	06	3/8-18	38,3	36,0	
1232647	-0808	NA	08	13,0	1/2"	08	1/2-14	42,3	36,0	
1232648	-1212	CR	12	19,0	3/4"	12	3/4-14	50,1	41,0	
1232649	-1616	NA	16	25,0	1"	16	1-11 1/2	57,9	41,0	

**// C12A12881**  
**90° Compact NPTF Male Swivel 60° Seat**

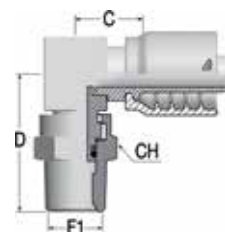

Item Code	Tale/Head Dash	Nut Type	ID			F1		C	D Drop	CH
			Dash	mm	in	Dash Size	F1			
1232651	-0404	CR	04	6,0	1/4"	04	1/4-18	17,0	39,0	17,0
1232652	-0606	CR	06	10,0	3/8"	06	3/8-18	20,0	41,0	22,0
1232653	-0808	CR	08	13,0	1/2"	08	1/2-14	23,0	48,0	22,0

Dimensions shown may be changed without prior notice

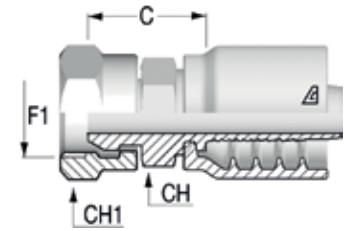
**// NPSM INSERTS****// C12A27311****NPSM Female**

Item Code	Tale/Head Dash	Nut Type	ID			F1		C	CH	CH1
			Dash	mm	in	Dash Size	F1			
1232957	-0404	CR	04	6,0	1/4"	04	1/4-18	24,3	19,0	19,0
1232958	-0606	CR	06	10,0	3/8"	06	3/8-18	24,8	22,0	22,0
1232959	-0808	CR	08	13,0	1/2"	08	1/2-14	26,6	22,0	27,0
1232960	-1212	CR	12	19,0	3/4"	12	3/4-14	28,6	32,0	32,0
1232961	-1616	CR	16	25,0	1"	16	1-11 1/2	35,4	36,0	38,0

# // ORFS INSERTS

## // C12A12410 ORFS Male

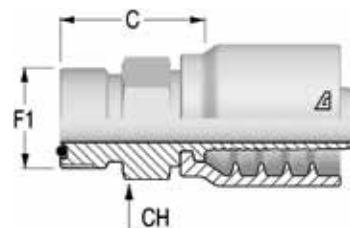

Item Code	Tale/Head	Nut Type	ID			F1	F1	C	CH
	Dash		Dash	mm	in	Dash Size			
1232593	-0404	NA	04	6,0	1/4"	04	9/16-18	22,3	17,0
1232594	-0406	NA	04	6,0	1/4"	06	11/16-16	24,3	19,0
1232595	-0606	NA	06	10,0	3/8"	06	11/16-16	24,3	19,0
1232596	-0608	NA	06	10,0	3/8"	08	13/16-16	26,3	22,0
1232597	-0610	NA	06	10,0	3/8"	10	1-14	29,8	27,0
1232598	-0808	NA	08	13,0	1/2"	08	13/16-16	27,1	22,0
1232599	-0810	NA	08	13,0	1/2"	10	1-14	30,6	27,0
1232600	-0812	NA	08	13,0	1/2"	12	1 3/16-12	34,1	32,0
1232601	-1010	NA	10	16,0	5/8"	10	1-14	30,6	27,0
1232602	-1012	NA	10	16,0	5/8"	12	1 3/16-12	34,1	32,0
1232603	-1212	NA	12	19,0	3/4"	12	1 3/16-12	34,6	32,0
1232604	-1216	NA	12	19,0	3/4"	16	1 7/16-12	38,1	41,0
1232605	-1616	NA	16	25,0	1"	16	1 7/16-12	37,9	38,0

## // C12A22411 ORFS Female with Stem Hexagon

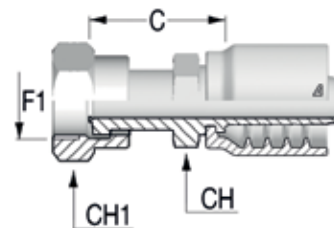

Item Code	Tale/Head	Nut Type	ID			F1	F1	C	CH	CH1
	Dash		Dash	mm	in	Dash Size				
1232783	-0404	CR	04	6,0	1/4"	04	9/16-18	27,3	14,0	17,0
1232784	-0406	CR	04	6,0	1/4"	06	11/16-16	30,3	17,0	22,0
1232785	-0408	CR	04	6,0	1/4"	08	13/16-16	35,3	22,0	24,0
1232786	-0506	CR	05	8,0	5/16"	06	11/16-16	30,3	17,0	22,0
1232787	-0606	CR	06	10,0	3/8"	06	11/16-16	30,3	17,0	22,0
1232788	-0608	CR	06	10,0	3/8"	08	13/16-16	35,3	22,0	24,0
1232789	-0806	CR	08	13,0	1/2"	06	11/16-16	32,1	19,0	22,0
1232790	-0808	CR	08	13,0	1/2"	08	13/16-16	36,1	22,0	24,0
1232791	-0810	CR	08	13,0	1/2"	10	1-14	39,6	24,0	30,0
1232792	-0812	CR	08	13,0	1/2"	12	1 3/16-12	42,1	30,0	36,0
1232793	-1010	CR	10	16,0	5/8"	10	1-14	39,6	24,0	30,0
1232794	-1012	CR	10	16,0	5/8"	12	1 3/16-12	42,1	30,0	36,0
1232795	-1210	CR	12	19,0	3/4"	10	1-14	40,1	27,0	30,0
1232796	-1212	CR	12	19,0	3/4"	12	1 3/16-12	42,6	30,0	36,0
1232797	-1216	CR	12	19,0	3/4"	16	1 7/16-12	48,6	36,0	41,0
1232798	-1612	CR	16	25,0	1"	12	1 3/16-12	45,4	32,0	36,0
1232799	-1616	CR	16	25,0	1"	16	1 7/16-12	49,4	36,0	41,0
1232800	-1620	CR	16	25,0	1"	20	1 11/16-12	50,4	41,0	50,0

Dimensions shown may be changed without prior notice

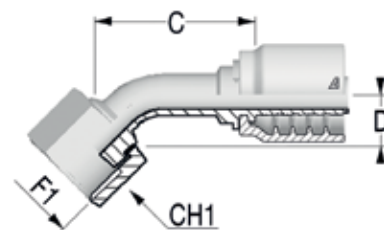
**// C12A22443-M****45° ORFS Female - Medium Drop****DK ORFS 45M****Solid one piece**

Item Code	Tale/Head Dash	Nut Type	ID			F1		F1	C	D Drop	CH1
			Dash	mm	in	Dash Size	mm				
1232802	-0404	SN	04	6,0	1/4"	04	9/16-18	41,1	11,0	17,0	
1232803	-0406	SN	04	6,0	1/4"	06	11/16-16	46,1	11,0	22,0	
1232804	-0506	SN	05	8,0	5/16"	06	11/16-16	46,3	12,0	22,0	
1232805	-0606	SN	06	10,0	3/8"	06	11/16-16	47,4	12,0	22,0	
1232806	-0608	SN	06	10,0	3/8"	08	13/16-16	51,2	15,0	24,0	
1232801	-0808	CR	08	13,0	1/2"	08	13/16-16	47,1	16,0	24,0	
1232807	-0810	SN	08	13,0	1/2"	10	1-14	50,4	16,5	30,0	
1232808	-1010	SN	10	16,0	5/8"	10	1-14	57,7	17,0	30,0	
1232809	-1012	SN	10	16,0	5/8"	12	1 3/16-12	63,1	21,0	36,0	
1232810	-1212	SN	12	19,0	3/4"	12	1 3/16-12	63,5	21,0	36,0	
1232811	-1216	SN	12	19,0	3/4"	16	1 7/16-12	70,7	24,0	41,0	
1232812	-1616	SN	16	25,0	1"	16	1 7/16-12	82,4	26,0	41,0	
1232813	-1620	SN	16	25,0	1"	20	1 11/16-12	85,4	26,0	50,0	

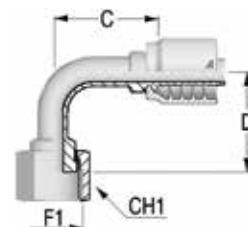
**// C12A22493-S****90° ORFS Female - Short Drop****DK ORFS 90S****Solid one piece**

Item Code	Tale/Head Dash	Nut Type	ID			F1		F1	C	D Drop	CH1
			Dash	mm	in	Dash Size	mm				
1232819	-0404	SN	04	6,0	1/4"	04	9/16-18	28,5	21,0	17,0	
1232822	-0406	SN	04	6,0	1/4"	06	11/16-16	32,0	23,0	22,0	
1232826	-0606	SN	06	10,0	3/8"	06	11/16-16	41,8	25,0	22,0	
1232829	-0608	SN	06	10,0	3/8"	08	13/16-16	41,8	29,0	24,0	
1232816	-0808	CR	08	13,0	1/2"	08	13/16-16	39,8	29,0	24,0	
1232832	-0810	SN	08	13,0	1/2"	10	1-14	46,3	32,5	30,0	
1232835	-1010	SN	10	16,0	5/8"	10	1-14	52,3	32,5	30,0	
1232837	-1012	SN	10	16,0	5/8"	12	1 3/16-12	55,4	49,0	36,0	
1232840	-1212	SN	12	19,0	3/4"	12	1 3/16-12	60,6	51,0	36,0	
1232842	-1216	SN	12	19,0	3/4"	16	1 7/16-12	61,6	56,0	41,0	
1232845	-1616	SN	16	25,0	1"	16	1 7/16-12	80,0	58,0	41,0	
1232847	-1620	SN	16	25,0	1"	20	1 11/16-12	82,6	64,0	50,0	

## // C12A22493-M

90° ORFS Female - Medium Drop

DK ORFS 90M

Solid one piece

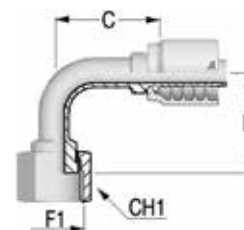

Item Code	Tale/Head Dash	Nut Type	ID			F1		F1	C	D Drop	CH1
			Dash	mm	in	Dash Size	mm				
1232818	-0404	SN	04	6,0	1/4"	04	9/16-18	29,8	32,0	17,0	
1232821	-0406	SN	04	6,0	1/4"	06	11/16-16	37,3	38,0	22,0	
1232823	-0506	SN	05	8,0	5/16"	06	11/16-16	40,7	34,0	22,0	
1232825	-0606	SN	06	10,0	3/8"	06	11/16-16	41,8	38,0	22,0	
1232828	-0608	SN	06	10,0	3/8"	08	13/16-16	43,8	41,0	24,0	
1232815	-0808	CR	08	13,0	1/2"	08	13/16-16	34,8	42,0	24,0	
1232831	-0810	SN	08	13,0	1/2"	10	1-14	48,3	47,0	30,0	
1232834	-1010	SN	10	16,0	5/8"	10	1-14	55,4	44,0	30,0	
1232836	-1012	SN	10	16,0	5/8"	12	1 3/16-12	55,4	58,0	36,0	
1232839	-1212	SN	12	19,0	3/4"	12	1 3/16-12	61,6	58,0	36,0	
1232841	-1216	SN	12	19,0	3/4"	16	1 7/16-12	65,6	71,0	41,0	
1232844	-1616	SN	16	25,0	1"	16	1 7/16-12	82,6	66,0	41,0	
1232846	-1620	SN	16	25,0	1"	20	1 11/16-12	82,6	78,0	50,0	

## // C12A22493-L

90° ORFS Female - Long Drop

DK ORFS 90L

Solid one piece

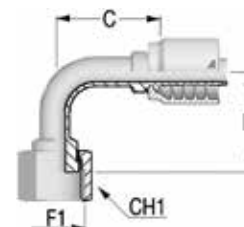

Item Code	Tale/Head Dash	Nut Type	ID			F1		F1	C	D Drop	CH1
			Dash	mm	in	Dash Size	mm				
1232817	-0404	CR	04	6,0	1/4"	04	9/16-18	32,8	46,0	24,0	
1232820	-0406	SN	04	6,0	1/4"	06	11/16-16	34,8	54,0	30,0	
1232824	-0606	SN	06	10,0	3/8"	06	11/16-16	41,8	54,0	30,0	
1232827	-0608	SN	06	10,0	3/8"	08	13/16-16	46,8	64,0	30,0	
1232814	-0808	CR	08	13,0	1/2"	08	13/16-16	38,3	64,0	30,0	
1232830	-0810	SN	08	13,0	1/2"	10	1-14	46,3	70,0	36,0	
1232833	-1010	SN	10	16,0	5/8"	10	1-14	55,4	70,0	36,0	
1232838	-1212	SN	12	19,0	3/4"	12	1 3/16-12	61,6	96,0	41,0	
1232843	-1616	SN	16	25,0	1"	16	1 7/16-12	82,6	114,0	41,0	

Dimensions shown may be changed without prior notice

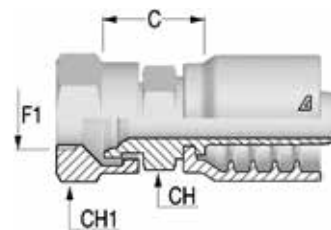
**// JIS INSERTS****// C12A2381Z****JIS Female 60° Seat Flare - B 8363 (type F)**

Item Code	Tale/Head Dash	Nut Type	ID			F1		C	CH	CH1
			Dash	mm	in	Dash Size	F1			
1232922	-0404	CR	04	6,0	1/4"	04	1/4-19	20,8	17,0	19,0
1232923	-0606	CR	06	10,0	3/8"	06	3/8-19	21,8	19,0	22,0
1232924	-0808	CR	08	13,0	1/2"	08	1/2-14	23,6	22,0	27,0
1232925	-1212	CR	12	19,0	3/4"	12	3/4-14	27,1	30,0	36,0
1232926	-1616	CR	16	25,0	1"	16	1-11	32,9	36,0	41,0



## // KOMATSU INSERTS

## // C12A24011

## Komatsu Female

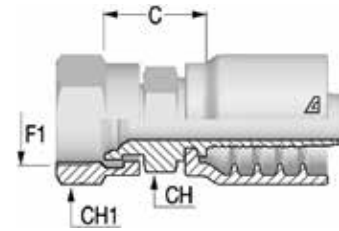

Item Code	Tale/Head Dash	Nut Type	ID			F1		F1	C	CH	CH1
			Dash	mm	in	Dash Size	mm				
1232927	-0414	CR	04	6,0	1/4"	14	M14X1.5	20,8	17,0	19,0	
1232928	-0618	CR	06	10,0	3/8"	18	M18X1.5	21,8	19,0	22,0	
1232929	-0822	CR	08	13,0	1/2"	22	M22X1.5	23,6	22,0	27,0	
1232930	-1024	CR	10	16,0	5/8"	24	M24X1.5	27,1	32,0	32,0	
1232931	-1230	CR	12	19,0	3/4"	30	M30X1.5	27,6	30,0	36,0	
1232932	-1633	CR	16	25,0	1"	33	M33X1.5	35,7	41,0	41,0	

Dimensions shown may be changed without prior notice

## // SAE FLANGES

## // C12A43310

Flange SAE 3000 PSI J518 Code 61 - SFL

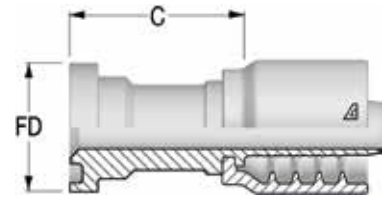

Item Code	Tale/Head	ID	Flange	Flange Size	C	FD	WP		
	Dash							Dash	mm
1232962	-0808	08	13,0	1/2"	08	1/2	41,0	30,2	5000
1232963	-0812	08	13,0	1/2"	12	3/4	42,0	38,1	5000
1232964	-1212	12	19,0	3/4"	12	3/4	42,5	38,1	5000
1232965	-1216	12	19,0	3/4"	16	1	50,5	44,5	5000
1232966	-1616	16	25,0	1"	16	1	51,4	44,5	5000
1232967	-1620	16	25,0	1"	20	1 1/4	53,9	50,8	4000

## // C12A43340

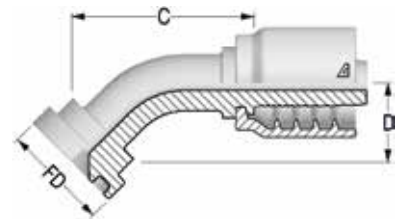
45° Flange SAE 3000 PSI J518 Code 61 - SFL 45  
Solid one piece

Item Code	Tale/Head	ID	Flange	Flange Size	FD	C	D Drop	WP		
	Dash								Dash	mm
1232968	-0808	08	13,0	1/2"	08	1/2	30,2	52,9	22,0	5000
1232969	-0812	08	13,0	1/2"	12	3/4	38,1	60,3	26,0	5000
1232970	-1012	10	16,0	5/8"	12	3/4	38,1	65,0	26,0	5000
1232971	-1212	12	19,0	3/4"	12	3/4	38,1	73,7	32,0	5000
1232972	-1216	12	19,0	3/4"	16	1	44,5	77,9	29,0	5000
1232973	-1616	16	25,0	1"	16	1	44,5	82,7	33,5	5000
1232974	-1620	16	25,0	1"	20	1 1/4	50,8	82,2	36,0	4000

## // C12A43390

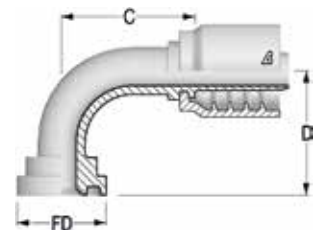
90° Flange SAE 3000 PSI J518 Code 61 - SFL 90  
Solid one piece

Item Code	Tale/Head	ID	Flange	Flange Size	FD	C	D Drop	WP		
	Dash								Dash	mm
1232975	-0808	08	13,0	1/2"	08	1/2	30,2	45,8	42,0	5000
1232976	-0812	08	13,0	1/2"	12	3/4	38,1	45,3	51,0	5000
1232977	-1212	12	19,0	3/4"	12	3/4	38,1	59,7	58,0	5000
1232978	-1216	12	19,0	3/4"	16	1	44,5	66,2	64,5	5000
1232979	-1616	16	25,0	1"	16	1	44,5	70,6	67,0	5000
1232980	-1620	16	25,0	1"	20	1 1/4	50,8	73,6	71,0	4000
1232981	-1624	16	25,0	1"	24	1 1/2	60,3	93,1	75,0	3000

## // C12A43610

## Flange SAE 6000 PSI J518 Code 62 - SFS

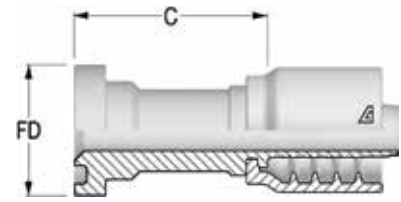

Item Code	Tale/Head	ID	Flange	Flange Size	C	FD	WP		
	Dash							Dash	Dash Size
1232982	-0808	08	13,0	1/2"	08	1/2	47,0	31,8	6000
1232983	-0812	08	13,0	1/2"	12	3/4	52,0	41,3	6000
1232984	-1212	12	19,0	3/4"	12	3/4	52,5	41,3	6000
1232985	-1216	12	19,0	3/4"	16	1	55,5	47,6	6000
1232986	-1612	16	25,0	1"	12	3/4	56,4	41,3	6000
1232987	-1616	16	25,0	1"	16	1	56,4	47,6	6000
1232988	-1620	16	25,0	1"	20	1 1/4	63,4	54,0	6000

## // C12A43640

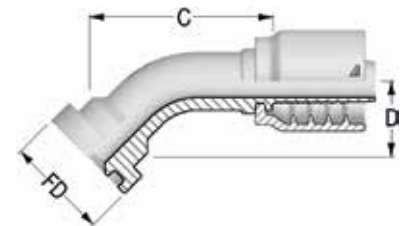
45° Flange SAE 6000 PSI J518 Code 62 - SFS 45  
Solid one piece

Item Code	Tale/Head	ID	Flange	Flange Size	FD	C	D Drop	WP		
	Dash								Dash	Dash Size
1232989	-0808	08	13,0	1/2"	08	1/2	31,8	56,5	23,0	6000
1232990	-0812	08	13,0	1/2"	12	3/4	41,3	79,9	30,5	6000
1232991	-1212	12	19,0	3/4"	12	3/4	41,3	84,1	31,0	6000
1232992	-1216	12	19,0	3/4"	16	1	47,6	80,0	33,5	6000
1232993	-1616	16	25,0	1"	16	1	47,6	96,7	36,0	6000
1232994	-1620	16	25,0	1"	20	1 1/4	54,0	96,1	39,0	6000

## // C12A43690

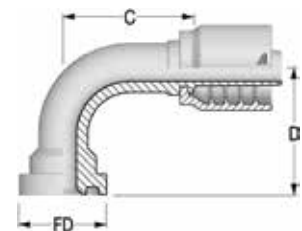
90° Flange SAE 6000 PSI J518 Code 62 - SFS 90  
Solid one piece

Item Code	Tale/Head	ID	Flange	Flange Size	FD	C	D Drop	WP		
	Dash								Dash	Dash Size
1232995	-0808	08	13,0	1/2"	08	1/2	31,8	47,8	46,0	6000
1232996	-0812	08	13,0	1/2"	12	3/4	41,3	47,8	54,0	6000
1232997	-1012	10	16,0	5/8"	12	3/4	41,3	49,9	55,0	6000
1232998	-1212	12	19,0	3/4"	12	3/4	41,3	63,2	61,0	6000
1232999	-1216	12	19,0	3/4"	16	1	47,6	63,2	66,0	6000
1233000	-1616	16	25,0	1"	16	1	47,6	73,6	75,0	6000
1233001	-1620	16	25,0	1"	20	1 1/4	54,0	77,6	78,0	6000



## // ALFACRIMP // C124

// BSP INSERTS .....	164	// NPTF INSERTS .....	176
// DIN METRIC INSERTS .....	167	// ORFS INSERTS .....	178
// SAE INSERTS .....	171	// SAE FLANGES .....	181
// JIC 37° INSERTS .....	172	// C122 SAE FLANGES .....	184

## // BSP INSERTS

## // C12410510

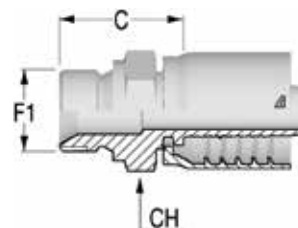
**BSPP Male 60° Flare  
AGR**

Item Code	Tale/Head	Nut Type	ID			F1	F1	C	CH
	Dash		Dash	mm	in	Dash Size		mm	mm
1215573	-0606	NA	06	10,0	3/8"	06	3/8-19	27,8	22,0
1233019	-0608	NA	06	10,0	3/8"	08	1/2-14	31,3	27,0
1233020	-0806	NA	08	13,0	1/2"	06	3/8-19	28,6	22,0
1233021	-0808	NA	08	13,0	1/2"	08	1/2-14	32,1	27,0
1233022	-0810	NA	08	13,0	1/2"	10	5/8-14	34,1	30,0
1215574	-0812	NA	08	13,0	1/2"	12	3/4-14	36,1	32,0
1233023	-1010	NA	10	16,0	5/8"	10	5/8-14	34,1	30,0
1233024	-1012	NA	10	16,0	5/8"	12	3/4-14	36,1	32,0
1215575	-1212	NA	12	19,0	3/4"	12	3/4-14	36,6	32,0
1233025	-1216	NA	12	19,0	3/4"	16	1-11	41,6	41,0
1215576	-1616	NA	16	25,0	1"	16	1-11	42,4	41,0
1233026	-1620	NA	16	25,0	1"	20	1 1/4-11	46,4	50,0
1215577	-2020	NA	20	32,0	1 1/4"	20	1 1/4-11	48,0	50,0
1215578	-2424	NA	24	38,0	1 1/2"	24	1 1/2-11	51,0	55,0
1215579	-3232	NA	32	51,0	2"	32	2-11	53,5	70,0

## // C12410710

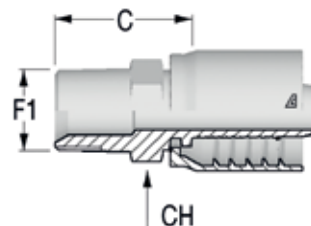
**BSPT Male  
AGR K**

Item Code	Tale/Head	Nut Type	ID			F1	F1	C	CH
	Dash		Dash	mm	in	Dash Size		mm	mm
1215580	-0606	NA	06	10,0	3/8"	06	3/8-19	27,8	19,0
1215581	-0608	NA	06	10,0	3/8"	08	1/2-14	32,3	22,0
1215582	-0808	NA	08	13,0	1/2"	08	1/2-14	33,1	22,0
1215583	-1012	NA	10	16,0	5/8"	12	3/4-14	34,1	27,0
1215584	-1212	NA	12	19,0	3/4"	12	3/4-14	34,6	27,0
1215585	-1216	NA	12	19,0	3/4"	16	1-11	43,6	36,0
1215586	-1616	NA	16	25,0	1"	16	1-11	44,4	36,0
1215587	-2020	NA	20	32,0	1 1/4"	20	1 1/4-11	49,0	46,0
1215588	-2424	NA	24	38,0	1 1/2"	24	1 1/2-11	50,5	50,0
1215589	-3232	NA	32	51,0	2"	32	2-11	54,2	65,0

Dimensions shown may be changed without prior notice

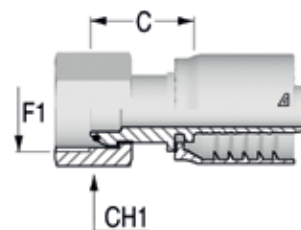
**// C12420813****BSP Female 60° Cone with O-Ring  
DKOR**

Item Code	Tale/Head Dash	Nut Type	ID			F1		C	CH1
			Dash	mm	in	Dash Size	F1		
1215665	-0606	SN	06	10,0	3/8"	06	3/8-19	23,3	22,0
1215666	-0608	SN	06	10,0	3/8"	08	1/2-14	24,3	27,0
1215667	-0808	SN	08	13,0	1/2"	08	1/2-14	25,1	27,0
1215668	-0810	SN	08	13,0	1/2"	10	5/8-14	28,4	27,0
1215669	-0812	SN	08	13,0	1/2"	12	3/4-14	29,0	32,0
1215659	-1010	CR	10	16,0	5/8"	10	5/8-14	17,1	27,0
1215670	-1012	SN	10	16,0	5/8"	12	3/4-14	29,0	32,0
1215660	-1212	CR	12	19,0	3/4"	12	3/4-14	20,6	32,0
1215671	-1216	SN	12	19,0	3/4"	16	1-11	34,0	38,0
1215661	-1616	CR	16	25,0	1"	16	1-11	23,9	38,0
1215672	-1620	SN	16	25,0	1"	20	1 1/4-11	39,4	50,0
1215662	-2020	TN	20	32,0	1 1/4"	20	1 1/4-11	32,0	50,0
1215673	-2024	SN	20	32,0	1 1/4"	24	1 1/2-11	41,9	55,0
1215663	-2424	TN	24	38,0	1 1/2"	24	1 1/2-11	33,8	55,0
1215664	-3232	TN	32	51,0	2"	32	2-11	34,0	70,0

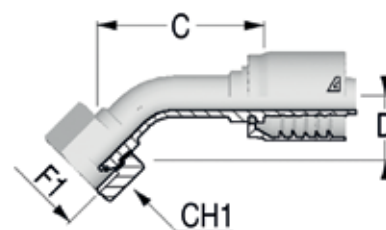
**// C12420843****45° BSP Female 60° Cone with O-Ring  
DKOR 45  
Solid one piece**

Item Code	Tale/Head Dash	Nut Type	ID			F1		C	D Drop	CH1
			Dash	mm	in	Dash Size	F1			
1215681	-0606	SN	06	10,0	3/8"	06	3/8-19	49,9	20,5	22,0
1215682	-0608	SN	06	10,0	3/8"	08	1/2-14	45,7	21,0	27,0
1215683	-0808	SN	08	13,0	1/2"	08	1/2-14	55,0	21,0	27,0
1215684	-0810	SN	08	13,0	1/2"	10	5/8-14	57,2	23,0	27,0
1215685	-0812	SN	08	13,0	1/2"	12	3/4-14	56,7	23,0	32,0
1215674	-1010	CR	10	16,0	5/8"	10	5/8-14	64,0	21,5	27,0
1215686	-1012	SN	10	16,0	5/8"	12	3/4-14	66,5	22,5	32,0
1215675	-1212	CR	12	19,0	3/4"	12	3/4-14	70,0	28,0	32,0
1215687	-1216	SN	12	19,0	3/4"	16	1-11	74,6	31,5	38,0
1215677	-1616	CR	16	25,0	1"	16	1-11	84,0	34,0	38,0
1215678	-2020	TN	20	32,0	1 1/4"	20	1 1/4-11	100,8	40,0	50,0
1215679	-2424	TN	24	38,0	1 1/2"	24	1 1/2-11	115,7	46,0	55,0
1215680	-3232	TN	32	51,0	2"	32	2-11	151,5	60,0	70,0

## // C12420893

90° BSPP Female 60° Cone with O-Ring  
 DKOR 90  
 Solid one piece

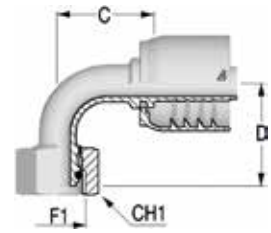

Item Code	Tale/Head Dash	Nut Type	ID		F1		F1	C	D Drop	CH1
			Dash	mm	in	Dash Size				
1215696	-0606	SN	06	10,0	3/8"	06	3/8-19	34,8	42,0	22,0
1215697	-0608	SN	06	10,0	3/8"	08	1/2-14	34,3	35,5	27,0
1215698	-0808	SN	08	13,0	1/2"	08	1/2-14	35,8	41,0	27,0
1215699	-0810	SN	08	13,0	1/2"	10	5/8-14	41,6	43,5	27,0
1233027	-0812	SN	08	13,0	1/2"	12	3/4-14	41,8	43,0	32,0
1215690	-1010	CR	10	16,0	5/8"	10	5/8-14	47,9	47,0	27,0
1233028	-1012	SN	10	16,0	5/8"	12	3/4-14	51,9	49,0	32,0
1215691	-1212	CR	12	19,0	3/4"	12	3/4-14	49,1	53,0	32,0
1215700	-1216	SN	12	19,0	3/4"	16	1-11	54,1	60,5	38,0
1215692	-1616	CR	16	25,0	1"	16	1-11	75,1	69,0	38,0
1233029	-1620	SN	16	25,0	1"	20	1 1/4-11	75,1	88,5	50,0
1215693	-2020	TN	20	32,0	1 1/4"	20	1 1/4-11	82,3	83,0	50,0
1215694	-2424	TN	24	38,0	1 1/2"	24	1 1/2-11	95,7	96,0	55,0
1215695	-3232	TN	32	51,0	2"	32	2-11	128,5	136,0	70,0

Dimensions shown may be changed without prior notice

## // DIN METRIC INSERTS

## // C12411110

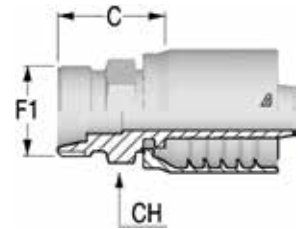
Metric Male 24° Seat - Light  
DIN 3853 - CEL

Item Code	Tale/Head Dash/mm	Nut Type	ID			F1	OD1 mm	C mm	CH mm
			Dash	mm	in				
1215590	-0616	NA	06	10,0	3/8"	M16X1.5	10	23,3	17,0
1215591	-0618	NA	06	10,0	3/8"	M18X1.5	12	24,3	19,0
1230378	-0622	NA	06	10,0	3/8"	M22X1.5	15	25,3	22,0
1215592	-0822	NA	08	13,0	1/2"	M22X1.5	15	26,1	22,0
1230379	-0826	NA	08	13,0	1/2"	M26X1.5	18	27,1	27,0
1215593	-1026	NA	10	16,0	5/8"	M26X1.5	18	27,1	27,0
1215594	-1230	NA	12	19,0	3/4"	M30X2	22	31,6	32,0
1215595	-1636	NA	16	25,0	1"	M36X2	28	34,4	36,0
1215596	-2045	NA	20	32,0	1 1/4"	M45X2	35	40,0	46,0
1233030	-2452	NA	24	38,0	1 1/2"	M52X2	42	42,0	55,0

## // C12421513

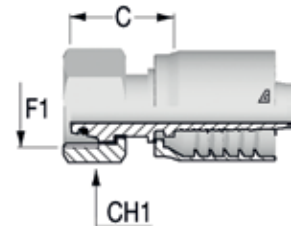
Metric Female 24° Cone with O-Ring - Light  
DIN 3865 - DKOL

Item Code	Tale/Head Dash/mm	Nut Type	ID			F1	OD1 mm	C mm	CH1 mm
			Dash	mm	in				
1215702	-0618	SN	06	10,0	3/8"	M18X1.5	12	25,4	22,0
1215703	-0822	SN	08	13,0	1/2"	M22X1.5	15	28,2	27,0
1215704	-1026	SN	10	16,0	5/8"	M26X1.5	18	29,2	32,0
1215705	-1230	SN	12	19,0	3/4"	M30X2	22	31,7	36,0
1215706	-1636	SN	16	25,0	1"	M36X2	28	33,6	41,0
1215707	-2045	SN	20	32,0	1 1/4"	M45X2	35	40,1	50,0
1230386	-2452	SN	24	38,0	1 1/2"	M52X2	42	40,5	60,0



## // C12421543

**45° Metric Female 24° Cone with O-Ring - Light**  
**DIN 3865 - DKOL 45**  
**Solid one piece**

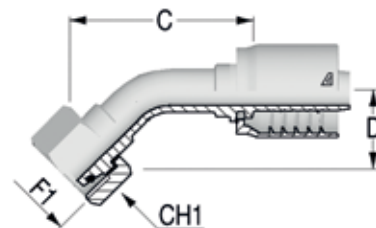

Item Code	Tale/Head Dash/mm	Nut Type	ID			F1	OD1 mm	C mm	D Drop mm	CH1 mm
			Dash	mm	in					
1215708	-0618	SN	06	10,0	3/8"	M18X1.5	12	46,8	19,5	22,0
1215709	-0822	SN	08	13,0	1/2"	M22X1.5	15	55,0	21,0	22,0
1215710	-1026	SN	10	16,0	5/8"	M26X1.5	18	65,3	24,0	32,0
1215711	-1230	SN	12	19,0	3/4"	M30X2	22	69,4	32,0	36,0
1215712	-1636	SN	16	25,0	1"	M36X2	28	91,4	32,0	41,0
1233031	-2045	SN	20	32,0	1 1/4"	M45X2	35	141,5	45,0	50,0

## // C12421593

**90° Metric Female 24° Cone with O-Ring - Light**  
**DIN 3865 - DKOL 90**  
**Solid one piece**

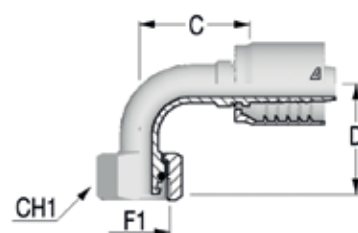

Item Code	Tale/Head Dash/mm	Nut Type	ID			F1	OD1 mm	C mm	D Drop mm	CH1 mm
			Dash	mm	in					
1215713	-0618	SN	06	10,0	3/8"	M18X1.5	12	32,8	39,0	22,0
1215714	-0822	SN	08	13,0	1/2"	M22X1.5	15	39,8	40,5	27,0
1215715	-1026	SN	10	16,0	5/8"	M26X1.5	18	51,4	48,0	32,0
1215716	-1230	SN	12	19,0	3/4"	M30X2	22	52,1	59,0	36,0
1215717	-1636	SN	16	25,0	1"	M36X2	28	77,6	68,0	41,0
1215718	-2045	SN	20	32,0	1 1/4"	M45X2	35	90,5	89,0	50,0
1230388	-2452	SN	24	38,0	1 1/2"	M52X2	42	106,5	100,0	60,0

Dimensions shown may be changed without prior notice

## // C12411210

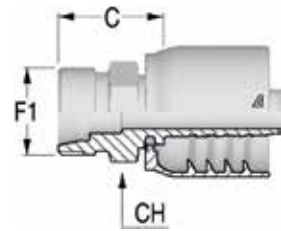
**Metric Male 24° Seat - Heavy  
DIN 3853 - CES**

Item Code	Tale/Head Dash/mm	Nut Type	ID			F1	OD1 mm	C mm	CH mm
			Dash	mm	in				
1215597	-0620	NA	06	10,0	3/8"	M20X1.5	12	25,3	22,0
1215598	-0622	NA	06	10,0	3/8"	M22X1.5	14	27,3	22,0
1215599	-0824	NA	08	13,0	1/2"	M24X1.5	16	29,1	24,0
1215600	-1030	NA	10	16,0	5/8"	M30X2	20	33,1	32,0
1215601	-1230	NA	12	19,0	3/4"	M30X2	20	33,6	32,0
1215602	-1236	NA	12	19,0	3/4"	M36X2	25	37,6	36,0
1215603	-1642	NA	16	25,0	1"	M42X2	30	42,4	46,0
1233032	-2052	NA	20	32,0	1 1/4"	M52X2	38	48,0	55,0

## // C12421613

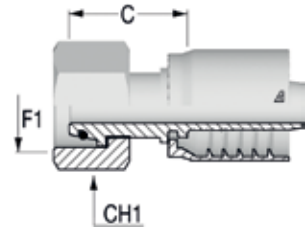
**Metric Female 24° Cone with O-Ring - Heavy  
DIN 3865 - DKOS**

Item Code	Tale/Head Dash/mm	Nut Type	ID			F1	OD1 mm	C mm	CH1 mm
			Dash	mm	in				
1215720	-0620	SN	06	10,0	3/8"	M20X1.5	12	27,6	24,0
1215721	-0622	SN	06	10,0	3/8"	M22X1.5	14	31,1	27,0
1215722	-0824	SN	08	13,0	1/2"	M24X1.5	16	31,7	30,0
1215723	-1030	SN	10	16,0	5/8"	M30X2	20	36,5	36,0
1215724	-1230	SN	12	19,0	3/4"	M30X2	20	37,0	36,0
1215725	-1236	SN	12	19,0	3/4"	M36X2	25	40,2	46,0
1230389	-1636	SN	16	25,0	1"	M36X2	25	41,0	46,0
1215726	-1642	SN	16	25,0	1"	M42X2	30	43,1	50,0
1215727	-2042	SN	20	32,0	1 1/4"	M42X2	30	44,7	50,0
1215728	-2052	SN	20	32,0	1 1/4"	M52X2	38	48,1	60,0

## // C12421643

**45° Metric Female 24° Cone with O-Ring - Heavy**  
**DIN 3865 - DKOS 45**  
**Solid one piece**

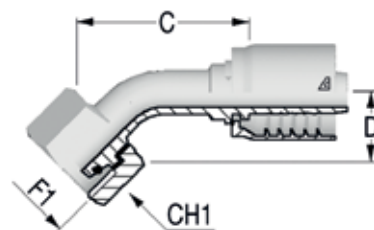

Item Code	Tale/Head Dash/mm	Nut Type	ID			F1	OD1 mm	C mm	D Drop mm	CH1 mm
			Dash	mm	in					
1215729	-0620	SN	06	10,0	3/8"	M20X1.5	12	50,6	20,0	24,0
1233033	-0622	SN	06	10,0	3/8"	M22X1.5	14	52,9	21,0	27,0
1215730	-0824	SN	08	13,0	1/2"	M24X1.5	16	55,8	21,5	30,0
1215731	-1030	SN	10	16,0	5/8"	M30X2	20	66,3	30,0	36,0
1215732	-1236	SN	12	19,0	3/4"	M36X2	25	69,5	33,0	46,0
1215733	-1642	SN	16	25,0	1"	M42X2	30	110,3	40,5	50,0
1215734	-2052	SN	20	32,0	1 1/4"	M52X2	38	109,0	45,0	60,0

## // C12421693

**90° Metric Female 24° Cone with O-Ring - Heavy**  
**DIN 3865 - DKOS 90**  
**Solid one piece**

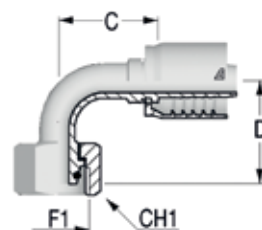

Item Code	Tale/Head Dash/mm	Nut Type	ID			F1	OD1 mm	C mm	D Drop mm	CH1 mm
			Dash	mm	in					
1215735	-0620	SN	06	10,0	3/8"	M20X1.5	12	34,3	38,5	24,0
1215736	-0622	SN	06	10,0	3/8"	M22X1.5	14	34,3	40,5	27,0
1215737	-0824	SN	08	13,0	1/2"	M24X1.5	16	39,8	41,5	30,0
1215738	-1030	SN	10	16,0	5/8"	M30X2	20	47,9	55,0	36,0
1215739	-1236	SN	12	19,0	3/4"	M36X2	25	50,6	59,5	46,0
1215740	-1642	SN	16	25,0	1"	M42X2	30	75,6	79,0	50,0
1215741	-2052	SN	20	32,0	1 1/4"	M52X2	38	94,0	92,0	60,0

Dimensions shown may be changed without prior notice

## // SAE INSERTS

## // C12413010

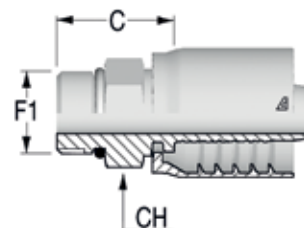
SAE Male Solid  
O-Ring Boss

Item Code	Tale/Head	Nut Type	ID			F1	F1	C	CH
	Dash		Dash	mm	in	Dash Size		mm	mm
1233039	-0606	NA	06	10,0	3/8"	06	9/16-18	23,3	19,0
1215653	-0808	NA	08	13,0	1/2"	08	3/4-16	25,1	22,0
1233040	-0810	NA	08	13,0	1/2"	10	7/8-14	27,6	27,0
1233041	-0812	NA	08	13,0	1/2"	12	1 1/16-12	32,1	32,0
1233042	-1012	NA	10	16,0	5/8"	12	1 1/16-12	32,1	32,0
1233043	-1210	NA	12	19,0	3/4"	10	7/8-14	28,1	27,0
1215654	-1212	NA	12	19,0	3/4"	12	1 1/16-12	32,6	32,0
1215655	-1216	NA	12	19,0	3/4"	16	1 5/16-12	34,6	38,0
1215656	-1616	NA	16	25,0	1"	16	1 5/16-12	35,4	38,0

## // JIC 37° INSERTS

## // C12412510

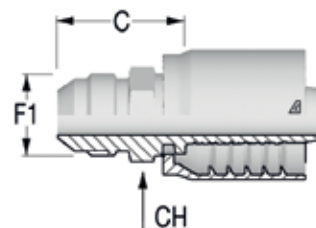
JIC Male 37° Cone  
AGJ

Item Code	Tale/Head	Nut Type	ID			F1		C	CH
	Dash		Dash	mm	in	Dash Size	F1		
1215616	-0606	NA	06	10,0	3/8"	06	9/16-18	26,3	17,0
1215617	-0608	NA	06	10,0	3/8"	08	3/4-16	29,8	19,0
1215618	-0808	NA	08	13,0	1/2"	08	3/4-16	30,6	19,0
1215619	-0810	NA	08	13,0	1/2"	10	7/8-14	34,6	24,0
1215620	-0812	NA	08	13,0	1/2"	12	1 1/16-12	37,1	27,0
1215621	-1010	NA	10	16,0	5/8"	10	7/8-14	34,6	24,0
1215622	-1012	NA	10	16,0	5/8"	12	1 1/16-12	37,1	27,0
1215623	-1212	NA	12	19,0	3/4"	12	1 1/16-12	37,6	27,0
1215624	-1214	NA	12	19,0	3/4"	14	1 3/16-12	40,1	32,0
1215625	-1216	NA	12	19,0	3/4"	16	1 5/16-12	42,6	36,0
1215626	-1616	NA	16	25,0	1"	16	1 5/16-12	43,4	36,0
1215627	-1620	NA	16	25,0	1"	20	1 5/8-12	46,9	46,0
1215628	-2020	NA	20	32,0	1 1/4"	20	1 5/8-12	48,5	46,0
1215630	-2424	NA	24	38,0	1 1/2"	24	1 7/8-12	52,5	50,0

## // C12422511

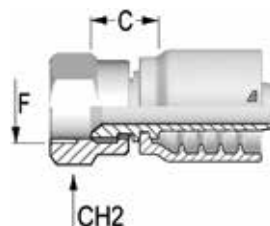
JIC Female 37° Seat  
DKJ

Item Code	Tale/Head	Nut Type	ID			F1		C	CH1
	Dash		Dash	mm	in	Dash Size	F1		
1215802	-0606	CR	06	10,0	3/8"	06	9/16-18	15,3	19,0
1233034	-0608	CR	06	10,0	3/8"	08	3/4-16	17,8	25,0
1230393	-0808	CR	08	13,0	1/2"	08	3/4-16	18,6	25,0
1215803	-0810	CR	08	13,0	1/2"	10	7/8-14	19,6	27,0
1215804	-0812	CR	08	13,0	1/2"	12	1 1/16-12	22,1	32,0
1215805	-1010	CR	10	16,0	5/8"	10	7/8-14	19,6	27,0
1215806	-1012	CR	10	16,0	5/8"	12	1 1/16-12	20,1	32,0
1215807	-1210	CR	12	19,0	3/4"	10	7/8-14	20,1	27,0
1215808	-1212	CR	12	19,0	3/4"	12	1 1/16-12	20,6	32,0
1215809	-1214	CR	12	19,0	3/4"	14	1 3/16-12	19,9	36,0
1233035	-1216	CR	12	19,0	3/4"	16	1 5/16-12	22,1	38,0
1230394	-1616	CR	16	25,0	1"	16	1 5/16-12	23,9	38,0
1233036	-1620	TN	16	25,0	1"	20	1 5/8-12	26,5	50,0
1215810	-2020	TN	20	32,0	1 1/4"	20	1 5/8-12	28,1	50,0
1233037	-2024	TN	20	32,0	1 1/4"	24	1 7/8-12	30,4	55,0
1215811	-2424	TN	24	38,0	1 1/2"	24	1 7/8-12	29,4	55,0
1215812	-3232	TN	32	51,0	2"	32	2 1/2-12	32,0	70,0

Dimensions shown may be changed without prior notice

## // C12426511

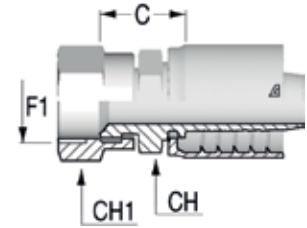
**JIC Female 37° Seat with Stem Hexagon  
DKJ**

Item Code	Tale/Head Dash	Nut Type	ID			F1		F1	C	CH	CH1
			Dash	mm	in	Dash Size	mm				
1215874	-0606	CR	06	10,0	3/8"	06	9/16-18	21,3	17,0	19,0	
1215875	-0608	CR	06	10,0	3/8"	08	3/4-16	24,8	19,0	25,0	
1215876	-0806	CR	08	13,0	1/2"	06	9/16-18	23,1	19,0	19,0	
1215877	-0808	CR	08	13,0	1/2"	08	3/4-16	25,6	19,0	25,0	
1215878	-0810	CR	08	13,0	1/2"	10	7/8-14	26,6	22,0	27,0	
1215879	-0812	CR	08	13,0	1/2"	12	1 1/16-12	28,1	25,0	32,0	
1215880	-1008	CR	10	16,0	5/8"	08	3/4-16	26,6	24,0	25,0	
1214172	-1010	CR	10	16,0	5/8"	10	7/8-14	27,6	24,0	27,0	
1215881	-1012	CR	10	16,0	5/8"	12	1 1/16-12	28,1	25,0	32,0	
1215883	-1212	CR	12	19,0	3/4"	12	1 1/16-12	28,6	27,0	32,0	
1215885	-1216	CR	12	19,0	3/4"	16	1 5/16-12	32,1	32,0	38,0	
1215886	-1612	CR	16	25,0	1"	12	1 1/16-12	31,4	32,0	32,0	
1215887	-1616	CR	16	25,0	1"	16	1 5/16-12	32,9	32,0	38,0	
1215888	-1620	TN	16	25,0	1"	20	1 5/8-12	37,5	41,0	50,0	
1215889	-2020	TN	20	32,0	1 1/4"	20	1 5/8-12	39,1	41,0	50,0	
1215890	-2024	TN	20	32,0	1 1/4"	24	1 7/8-12	43,4	50,0	55,0	
1215891	-2424	TN	24	38,0	1 1/2"	24	1 7/8-12	43,4	50,0	55,0	
1215892	-3232	TN	32	51,0	2"	32	2 1/2-12	49,0	65,0	70,0	

## // C12422541-M

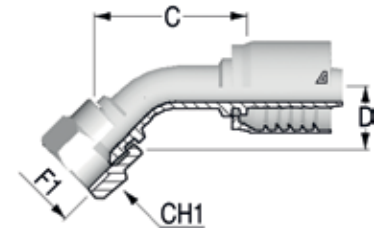
**45° JIC Female 37° Seat - Medium Drop  
DKJ 45M  
Solid one piece**

Item Code	Tale/Head Dash	Nut Type	ID			F1		F1	C	D Drop	CH1
			Dash	mm	in	Dash Size	mm				
1215813	-0606	CR	06	10,0	3/8"	06	9/16-18	46,3	11,0	19,0	
1215814	-0608	CR	06	10,0	3/8"	08	3/4-16	47,2	15,0	25,0	
1215815	-0808	CR	08	13,0	1/2"	08	3/4-16	51,6	15,0	25,0	
1215816	-0810	CR	08	13,0	1/2"	10	7/8-14	50,7	16,0	27,0	
1215817	-0812	CR	08	13,0	1/2"	12	1 1/16-12	57,0	21,0	32,0	
1215818	-1010	CR	10	16,0	5/8"	10	7/8-14	62,2	19,0	27,0	
1230395	-1012	CR	10	16,0	5/8"	12	1 1/16-12	68,6	21,0	32,0	
1215819	-1212	CR	12	19,0	3/4"	12	1 1/16-12	67,5	21,0	32,0	
1215821	-1216	CR	12	19,0	3/4"	16	1 5/16-12	71,4	26,0	38,0	
1215822	-1616	CR	16	25,0	1"	16	1 5/16-12	79,4	24,0	38,0	
1215824	-1620	TN	16	25,0	1"	20	1 5/8-12	83,8	37,0	50,0	
1215825	-2020	TN	20	32,0	1 1/4"	20	1 5/8-12	97,1	37,0	50,0	
1215827	-2424	TN	24	38,0	1 1/2"	24	1 7/8-12	112,7	43,0	55,0	
1215828	-3232	TN	32	51,0	2"	32	2 1/2-12	159,9	67,0	70,0	

## // C12422591-S

90° JIC Female 37° Seat - Short Drop  
DKJ 90S  
Solid one piece

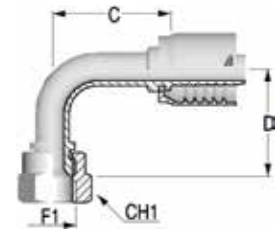

Item Code	Tale/Head Dash	Nut Type	ID			F1		F1	C	D Drop	CH1
			Dash	mm	in	Dash Size					
1230396	-0812	CR	08	13,0	1/2"	12	1 1/16-12	37,3	46,0	32,0	
1215850	-1212	CR	12	19,0	3/4"	12	1 1/16-12	58,2	46,0	32,0	
1215854	-1216	CR	12	19,0	3/4"	16	1 5/16-12	53,6	53,0	38,0	
1215857	-1616	CR	16	25,0	1"	16	1 5/16-12	74,0	56,0	38,0	

## // C12422591-M

90° JIC Female 37° Seat - Medium Drop  
DKJ 90M  
Solid one piece

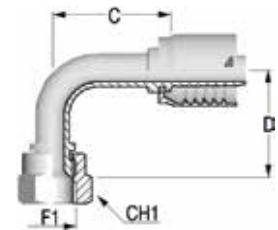

Item Code	Tale/Head Dash	Nut Type	ID			F1		F1	C	D Drop	CH1
			Dash	mm	in	Dash Size					
1215830	-0606	CR	06	10,0	3/8"	06	9/16-18	31,3	35,0	19,0	
1215833	-0608	CR	06	10,0	3/8"	08	3/4-16	39,5	41,0	25,0	
1215836	-0808	CR	08	13,0	1/2"	08	3/4-16	37,2	40,0	25,0	
1215839	-0810	CR	08	13,0	1/2"	10	7/8-14	43,3	47,0	27,0	
1233038	-0812	CR	08	13,0	1/2"	12	1 1/16-12	42,8	58,0	32,0	
1215842	-1010	CR	10	16,0	5/8"	10	7/8-14	49,4	48,0	27,0	
1215845	-1012	CR	10	16,0	5/8"	12	1 1/16-12	47,9	58,0	32,0	
1215849	-1212	CR	12	19,0	3/4"	12	1 1/16-12	52,4	54,0	32,0	
1215853	-1216	CR	12	19,0	3/4"	16	1 5/16-12	52,6	72,0	38,0	
1215856	-1616	CR	16	25,0	1"	16	1 5/16-12	72,6	71,5	38,0	
1230398	-1620	TN	16	25,0	1"	20	1 5/8-12	72,6	78,0	50,0	
1215858	-2020	TN	20	32,0	1 1/4"	20	1 5/8-12	82,4	78,0	50,0	
1215860	-2424	TN	24	38,0	1 1/2"	24	1 7/8-12	95,3	92,0	55,0	
1215861	-3232	TN	32	51,0	2"	32	2 1/2-12	129,5	140,0	70,0	

Dimensions shown may be changed without prior notice

**// C12422591-L**

**90° JIC Female 37° Seat - Long Drop**  
**DKJ 90L**  
**Solid one piece**

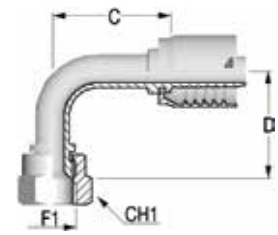

Item Code	Tale/Head Dash	Nut Type	ID		F1		F1	C	D Drop	CH1
			Dash	mm	in	Dash Size				
1215829	-0606	CR	06	10,0	3/8"	06	9/16-18	43,3	54,0	19,0
1215832	-0608	CR	06	10,0	3/8"	08	3/4-16	46,8	64,0	25,0
1215835	-0808	CR	08	13,0	1/2"	08	3/4-16	49,9	64,0	25,0
1215838	-0810	CR	08	13,0	1/2"	10	7/8-14	37,3	65,0	27,0
1215841	-1010	CR	10	16,0	5/8"	10	7/8-14	49,9	65,0	27,0
1215848	-1212	CR	12	19,0	3/4"	12	1 1/16-12	54,1	95,0	32,0
1215855	-1616	CR	16	25,0	1"	16	1 5/16-12	78,6	114,0	38,0



## // NPTF INSERTS

### // C12412810

**NPTF Male 60° Seat  
AGN**

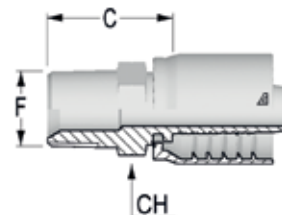

Item Code	Tale/Head	Nut Type	ID			F1	F1	C	CH
	Dash		Dash	mm	in	Dash Size			
1215632	-0604	NA	06	10,0	3/8"	04	1/4-18	26,8	17,0
1215633	-0606	NA	06	10,0	3/8"	06	3/8-18	27,8	19,0
1215634	-0608	NA	06	10,0	3/8"	08	1/2-14	31,3	22,0
1215635	-0806	NA	08	13,0	1/2"	06	3/8-18	28,6	19,0
1215636	-0808	NA	08	13,0	1/2"	08	1/2-14	32,1	22,0
1215637	-0812	NA	08	13,0	1/2"	12	3/4-14	34,1	27,0
1215638	-1012	NA	10	16,0	5/8"	12	3/4-14	34,1	27,0
1215639	-1208	NA	12	19,0	3/4"	08	1/2-14	33,6	27,0
1215640	-1212	NA	12	19,0	3/4"	12	3/4-14	34,6	27,0
1215641	-1216	NA	12	19,0	3/4"	16	1-11 1/2	43,6	36,0
1215643	-1616	NA	16	25,0	1"	16	1-11 1/2	44,4	36,0
1215644	-1620	NA	16	25,0	1"	20	1 1/4-11 1/2	47,4	46,0
1215645	-2020	NA	20	32,0	1 1/4"	20	1 1/4-11 1/2	49,0	46,0
1215646	-2024	NA	20	32,0	1 1/4"	24	1 1/2-11 1/2	50,5	50,0
1215647	-2424	NA	24	38,0	1 1/2"	24	1 1/2-11 1/2	50,5	50,0
1215648	-3232	NA	32	51,0	2"	32	2-11 1/2	54,2	65,0

### // C12422810

**NPTF Female Solid**

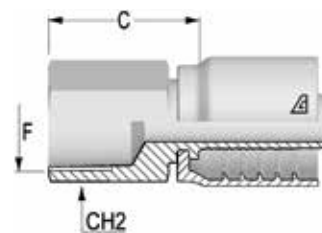

Item Code	Tale/Head	Nut Type	ID			F1	F1	C	CH
	Dash		Dash	mm	in	Dash Size			
1215862	-1212	NA	12	19,0	3/4"	12	3/4-14	38,1	32,0
1215863	-1616	NA	16	25,0	1"	16	1-11 1/2	44,9	38,0

Dimensions shown may be changed without prior notice

## // C12412811

### NPTF Male Swivel 60° Seat

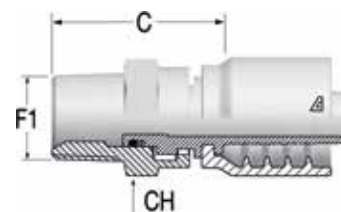

Item Code	Tale/Head Dash	Nut Type	ID			F1		C	CH
			Dash	mm	in	Dash Size	F1		
1215650	-0808	CR	08	13,0	1/2"	08	1/2-14	42,3	25,0
1215651	-1212	CR	12	19,0	3/4"	12	3/4-14	50,1	32,0
1215652	-1616	CR	16	25,0	1"	16	1-11 1/2	57,9	41,0

## // ORFS INSERTS

## // C12412410

## ORFS Male

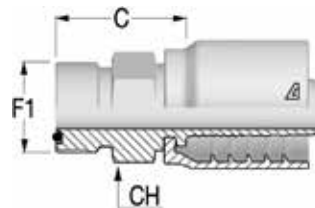

Item Code	Tale/Head	Nut Type	ID			F1	F1	C	CH
	Dash		Dash	mm	in	Dash Size			
1215604	-0606	NA	06	10,0	3/8"	06	11/16-16	24,3	19,0
1215606	-0808	NA	08	13,0	1/2"	08	13/16-16	27,1	22,0
1215607	-0810	NA	08	13,0	1/2"	10	1-14	30,6	27,0
1215611	-1212	NA	12	19,0	3/4"	12	1 3/16-12	34,6	32,0
1215612	-1216	NA	12	19,0	3/4"	16	1 7/16-12	38,1	41,0
1215613	-1616	NA	16	25,0	1"	16	1 7/16-12	37,9	38,0
1215615	-2020	NA	20	32,0	1 1/4"	20	1 11/16-12	41,5	46,0

## // C12422411

## ORFS Female with Stem Hexagon

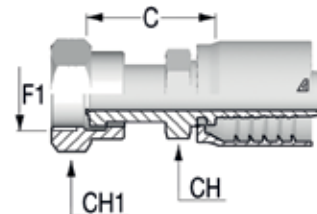

Item Code	Tale/Head	Nut Type	ID			F1	F1	C	CH	CH1
	Dash		Dash	mm	in	Dash Size				
1215742	-0606	CR	06	10,0	3/8"	06	11/16-16	30,3	17,0	22,0
1215743	-0608	CR	06	10,0	3/8"	08	13/16-16	35,3	22,0	24,0
1215744	-0808	CR	08	13,0	1/2"	08	13/16-16	36,1	22,0	24,0
1215745	-0810	CR	08	13,0	1/2"	10	1-14	39,6	24,0	30,0
1215746	-0812	CR	08	13,0	1/2"	12	1 3/16-12	42,1	30,0	36,0
1215747	-1010	CR	10	16,0	5/8"	10	1-14	39,6	24,0	30,0
1215748	-1012	CR	10	16,0	5/8"	12	1 3/16-12	42,1	30,0	36,0
1215749	-1210	CR	12	19,0	3/4"	10	1-14	40,1	27,0	30,0
1215750	-1212	CR	12	19,0	3/4"	12	1 3/16-12	42,6	30,0	36,0
1215751	-1216	CR	12	19,0	3/4"	16	1 7/16-12	48,6	36,0	41,0
1215752	-1612	CR	16	25,0	1"	12	1 3/16-12	45,4	32,0	36,0
1215753	-1616	CR	16	25,0	1"	16	1 7/16-12	49,4	36,0	41,0
1215754	-1620	CR	16	25,0	1"	20	1 11/16-12	50,4	41,0	50,0
1215755	-2020	CR	20	32,0	1 1/4"	20	1 11/16-12	52,0	41,0	50,0
1215756	-2424	CR	24	38,0	1 1/2"	24	2-12	56,5	50,0	60,0

Dimensions shown may be changed without prior notice

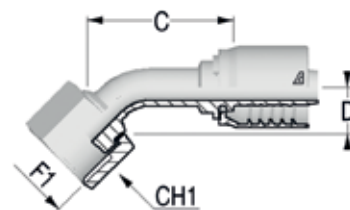
**// C12422443-M****45° ORFS Female - Medium Drop****DK ORFS 45M****Solid one piece**

Item Code	Tale/Head Dash	Nut Type	ID			F1 Dash Size	F1	C	D Drop	CH1
			Dash	mm	in					
1215759	-0606	SN	06	10,0	3/8"	06	11/16-16	47,4	12,0	22,0
1215760	-0608	SN	06	10,0	3/8"	08	13/16-16	51,2	15,0	24,0
1215757	-0808	CR	08	13,0	1/2"	08	13/16-16	47,1	16,0	24,0
1215761	-0810	SN	08	13,0	1/2"	10	1-14	50,4	16,5	30,0
1215762	-1010	SN	10	16,0	5/8"	10	1-14	57,7	17,0	30,0
1230391	-1012	SN	10	16,0	5/8"	12	1 3/16-12	63,1	21,0	36,0
1215763	-1212	SN	12	19,0	3/4"	12	1 3/16-12	63,5	21,0	36,0
1215764	-1216	SN	12	19,0	3/4"	16	1 7/16-12	70,7	24,0	41,0
1215765	-1616	SN	16	25,0	1"	16	1 7/16-12	82,4	26,0	41,0
1215766	-1620	SN	16	25,0	1"	20	1 11/16-12	85,4	26,0	50,0
1215767	-2020	SN	20	32,0	1 1/4"	20	1 11/16-12	97,4	26,0	50,0
1215769	-2424	SN	24	38,0	1 1/2"	24	2-12	104,4	28,0	60,0

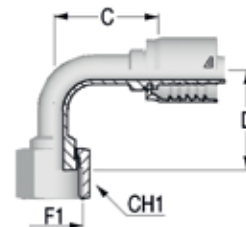
**// C12422493-S****90° ORFS Female - Short Drop****DK ORFS 90S****Solid one piece**

Item Code	Tale/Head Dash	Nut Type	ID			F1 Dash Size	F1	C	D Drop	CH1
			Dash	mm	in					
1215777	-0606	SN	06	10,0	3/8"	06	11/16-16	41,8	25,0	22,0
1215772	-0808	CR	08	13,0	1/2"	08	13/16-16	39,8	29,0	24,0
1215781	-0810	SN	08	13,0	1/2"	10	1-14	46,3	32,5	30,0
1233044	-1010	SN	10	16,0	5/8"	10	1-14	52,3	32,5	30,0
1215786	-1212	SN	12	19,0	3/4"	12	1 3/16-12	60,6	51,0	36,0
1215792	-1616	SN	16	25,0	1"	16	1 7/16-12	80,0	58,0	41,0
1215795	-2020	SN	20	32,0	1 1/4"	20	1 11/16-12	95,0	68,0	50,0

## // C12422493-M

90° ORFS Female - Medium Drop

DK ORFS 90M

Solid one piece

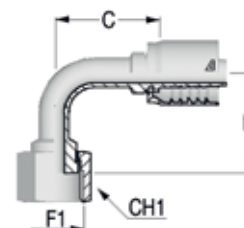

Item Code	Tale/Head Dash	Nut Type	ID			F1		F1	C	D Drop	CH1
			Dash	mm	in	Dash Size					
1215776	-0606	SN	06	10,0	3/8"	06	11/16-16	41,8	38,0	22,0	
1215778	-0608	SN	06	10,0	3/8"	08	13/16-16	43,8	41,0	24,0	
1215771	-0808	CR	08	13,0	1/2"	08	13/16-16	34,8	42,0	24,0	
1215780	-0810	SN	08	13,0	1/2"	10	1-14	48,3	47,0	30,0	
1215782	-1010	SN	10	16,0	5/8"	10	1-14	55,4	44,0	30,0	
1230392	-1012	SN	10	16,0	5/8"	12	1 3/16-12	55,4	58,0	36,0	
1215785	-1212	SN	12	19,0	3/4"	12	1 3/16-12	61,6	58,0	36,0	
1215788	-1216	SN	12	19,0	3/4"	16	1 7/16-12	65,6	71,0	41,0	
1215791	-1616	SN	16	25,0	1"	16	1 7/16-12	82,6	66,0	41,0	
1215794	-2020	SN	20	32,0	1 1/4"	20	1 11/16-12	97,0	78,0	50,0	
1215800	-2424	SN	24	38,0	1 1/2"	24	2-12	107,8	87,0	60,0	

## // C12422493-L

90° ORFS Female - Long Drop

DK ORFS 90L

Solid one piece

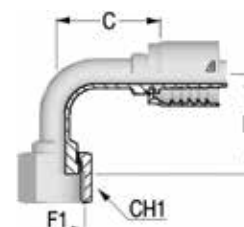

Item Code	Tale/Head Dash	Nut Type	ID			F1		F1	C	D Drop	CH1
			Dash	mm	in	Dash Size					
1215775	-0606	SN	06	10,0	3/8"	06	11/16-16	41,8	54,0	22,0	
1215770	-0808	CR	08	13,0	1/2"	08	13/16-16	38,3	64,0	24,0	
1215779	-0810	SN	08	13,0	1/2"	10	1-14	46,3	70,0	30,0	
1233045	-1010	SN	10	16,0	5/8"	10	1-14	55,4	70,0	30,0	
1215784	-1212	SN	12	19,0	3/4"	12	1 3/16-12	61,6	96,0	36,0	
1215790	-1616	SN	16	25,0	1"	16	1 7/16-12	82,6	114,0	41,0	

Dimensions shown may be changed without prior notice

## // SAE FLANGES

## // C12443310

Flange SAE 3000 PSI J518 Code 61 - SFL

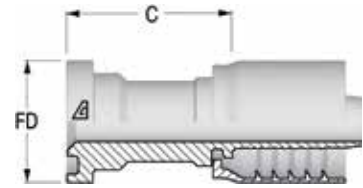

Item Code	Tale/Head		ID		Flange		C	FD	WP
	Dash	Dash	mm	in	Dash Size	Flange Size			
1215898	-0808	08	13,0	1/2"	08	1/2	41,0	30,2	5000
1215899	-0812	08	13,0	1/2"	12	3/4	42,0	38,1	5000
1215901	-1212	12	19,0	3/4"	12	3/4	42,5	38,1	5000
1215902	-1216	12	19,0	3/4"	16	1	50,5	44,5	5000
1215903	-1616	16	25,0	1"	16	1	51,4	44,5	5000
1215904	-1620	16	25,0	1"	20	1 1/4	53,9	50,8	4000
1215906	-2020	20	32,0	1 1/4"	20	1 1/4	55,5	50,8	4000
1215907	-2024	20	32,0	1 1/4"	24	1 1/2	58,5	60,3	3000
1215908	-2424	24	38,0	1 1/2"	24	1 1/2	58,5	60,3	3000
1215910	-3232	32	51,0	2"	32	2	70,0	71,4	3000
1215911	-3240	32	51,0	2"	40	2 1/2	83,0	81,1	2500

## // C12443340

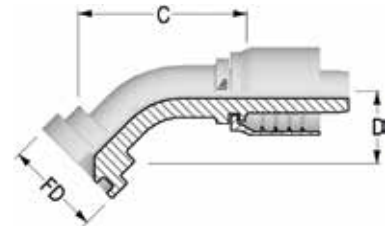
45° Flange SAE 3000 PSI J518 Code 61 - SFL 45  
Solid one piece

Item Code	Tale/Head		ID		Flange		FD	C	D Drop	WP
	Dash	Dash	mm	in	Dash Size	Flange Size				
1215931	-0808	08	13,0	1/2"	08	1/2	30,2	52,9	22,0	5000
1215932	-0812	08	13,0	1/2"	12	3/4	38,1	60,3	26,0	5000
1215933	-1212	12	19,0	3/4"	12	3/4	38,1	73,7	32,0	5000
1215934	-1216	12	19,0	3/4"	16	1	44,5	77,9	29,0	5000
1215935	-1616	16	25,0	1"	16	1	44,5	82,7	33,5	5000
1215936	-1620	16	25,0	1"	20	1 1/4	50,8	82,2	36,0	4000
1215937	-2020	20	32,0	1 1/4"	20	1 1/4	50,8	95,1	37,5	4000
1215938	-2024	20	32,0	1 1/4"	24	1 1/2	60,3	104,1	40,0	3000
1215939	-2424	24	38,0	1 1/2"	24	1 1/2	60,3	116,7	48,0	3000
1215940	-2432	24	38,0	1 1/2"	32	2	71,4	135,6	55,5	3000
1215941	-3232	32	51,0	2"	32	2	71,4	140,8	47,5	3000

## // C12443390

90° Flange SAE 3000 PSI J518 Code 61 - SFL 90  
Solid one piece

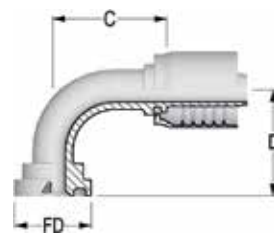

Item Code	Tale/Head		ID		Flange		Flange Size	FD	C	D Drop	WP
	Dash	Dash	mm	in	Dash Size	Dash Size					
1215959	-0808	08	13,0	1/2"	08	1/2	30,2	45,8	42,0	5000	
1215960	-0812	08	13,0	1/2"	12	3/4	38,1	45,3	51,0	5000	
1215961	-1212	12	19,0	3/4"	12	3/4	38,1	59,7	58,0	5000	
1215962	-1216	12	19,0	3/4"	16	1	44,5	66,2	64,5	5000	
1215966	-1616	16	25,0	1"	16	1	44,5	70,6	67,0	5000	
1215968	-1620	16	25,0	1"	20	1 1/4	50,8	73,6	71,0	4000	
1215969	-1624	16	25,0	1"	24	1 1/2	60,3	93,1	75,0	3000	
1215970	-2016	20	32,0	1 1/4"	16	1	44,5	94,4	65,0	5000	
1215971	-2020	20	32,0	1 1/4"	20	1 1/4	50,8	88,0	84,0	4000	
1215972	-2024	20	32,0	1 1/4"	24	1 1/2	60,3	91,5	87,5	3000	
1215973	-2424	24	38,0	1 1/2"	24	1 1/2	60,3	104,8	91,0	3000	
1215974	-2432	24	38,0	1 1/2"	32	2	71,4	104,8	115,0	3000	
1215975	-3232	32	51,0	2"	32	2	71,4	129,3	130,0	3000	

## // C12443610

Flange SAE 6000 PSI J518 Code 62 - SFS

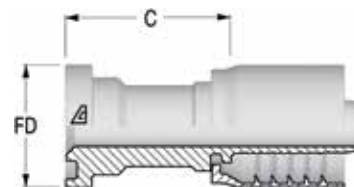

Item Code	Tale/Head		ID		Flange		C	FD	WP
	Dash	Dash	mm	in	Dash Size	Flange Size			
1215977	-0808	08	13,0	1/2"	08	1/2	47,0	31,8	6000
1215978	-0812	08	13,0	1/2"	12	3/4	52,0	41,3	6000
1215979	-1212	12	19,0	3/4"	12	3/4	52,5	41,3	6000
1215980	-1216	12	19,0	3/4"	16	1	55,5	47,6	6000
1215981	-1612	16	25,0	1"	12	3/4	56,4	41,3	6000
1215982	-1616	16	25,0	1"	16	1	56,4	47,6	6000
1215983	-1620	16	25,0	1"	20	1 1/4	63,4	54,0	6000
1215984	-2020	20	32,0	1 1/4"	20	1 1/4	83,0	54,0	6000
1215985	-2024	20	32,0	1 1/4"	24	1 1/2	71,0	63,5	6000
1215986	-2424	24	38,0	1 1/2"	24	1 1/2	101,0	63,5	6000
1215988	-3232	32	51,0	2"	32	2	76,0	79,4	6000

Dimensions shown may be changed without prior notice

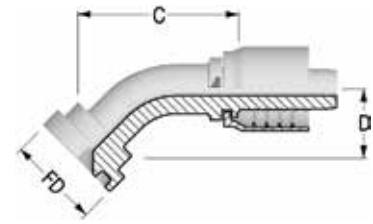
**// C12443640****45° Flange SAE 6000 PSI J518 Code 62 - SFS 45  
Solid one piece**

Item Code	Tale/Head		ID		Flange		Flange Size	FD	C	D Drop	WP
	Dash	Dash	mm	in	Dash Size	Dash Size					
1215999	-0808	08	13,0	1/2"	08	12	1/2	31,8	56,5	23,0	6000
1216000	-0812	08	13,0	1/2"	12	12	3/4	41,3	79,9	30,5	6000
1216001	-1212	12	19,0	3/4"	12	12	3/4	41,3	84,1	31,0	6000
1216002	-1216	12	19,0	3/4"	16	16	1	47,6	80,0	33,5	6000
1216003	-1616	16	25,0	1"	16	16	1	47,6	96,7	36,0	6000
1216004	-1620	16	25,0	1"	20	20	1 1/4	54,0	96,1	39,0	6000
1216005	-2020	20	32,0	1 1/4"	20	20	1 1/4	54,0	108,6	40,0	6000
1216006	-2024	20	32,0	1 1/4"	24	24	1 1/2	63,5	114,8	45,5	6000
1216007	-2424	24	38,0	1 1/2"	24	24	1 1/2	63,5	122,9	45,0	6000
1216009	-3232	32	51,0	2"	32	32	2	79,4	156,6	60,0	6000

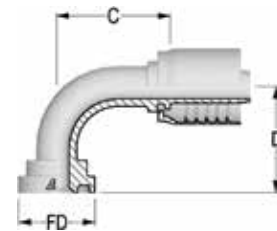
**// C12443690****90° Flange SAE 6000 PSI J518 Code 62 - SFS 90  
Solid one piece**

Item Code	Tale/Head		ID		Flange		Flange Size	FD	C	D Drop	WP
	Dash	Dash	mm	in	Dash Size	Dash Size					
1216015	-0808	08	13,0	1/2"	08	12	1/2	31,8	47,8	46,0	6000
1216016	-0812	08	13,0	1/2"	12	12	3/4	41,3	47,8	54,0	6000
1216017	-1012	10	16,0	5/8"	12	12	3/4	41,3	49,9	55,0	6000
1216018	-1212	12	19,0	3/4"	12	12	3/4	41,3	63,2	61,0	6000
1216019	-1216	12	19,0	3/4"	16	16	1	47,6	63,2	66,0	6000
1216021	-1616	16	25,0	1"	16	16	1	47,6	73,6	75,0	6000
1216022	-1620	16	25,0	1"	20	20	1 1/4	54,0	77,6	78,0	6000
1216023	-2020	20	32,0	1 1/4"	20	20	1 1/4	54,0	94,5	89,0	6000
1216024	-2024	20	32,0	1 1/4"	24	24	1 1/2	63,5	98,0	94,0	6000
1216025	-2424	24	38,0	1 1/2"	24	24	1 1/2	63,5	99,6	105,0	6000
1216027	-3232	32	51,0	2"	32	32	2	79,4	143,3	132,0	6000



## // C122 SAE FLANGES

## // C12243310

Flange SAE 3000 PSI J518 Code 61 - SFL

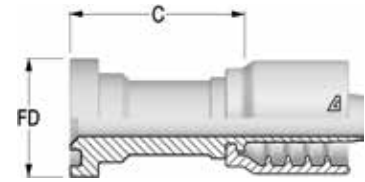

Item Code	Tale/Head		ID		Flange		Flange Size	C	FD	WP
	Dash	Dash	mm	in	Dash Size	Dash Size				
1203199	-4848	48	76,0	3"	48	3	55,0	101,6	2000	
1214123	-6464	64	102,0	4"	64	4	130,0	127,0	525	

## // C12243340

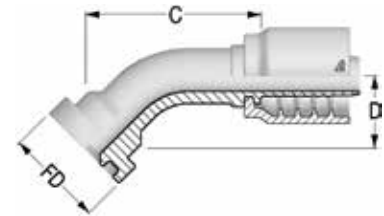
45° Flange SAE 3000 PSI J518 Code 61 - SFL 45  
Solid one piece

Item Code	Tale/Head		ID		Flange		FD	C	D Drop	WP
	Dash	Dash	mm	in	Dash Size	Dash Size				
1214132	-4848	48	76,0	3"	48	3	101,6	140,0	54,0	2000
1214133	-6464	64	102,0	4"	64	4	127,0	264,5	161,0	525

## // C12243390

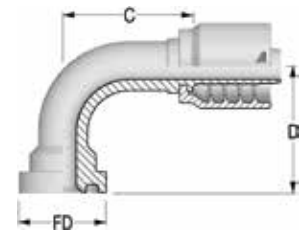
90° Flange SAE 3000 PSI J518 Code 61 - SFL 90  
Solid one piece

Item Code	Tale/Head		ID		Flange		FD	C	D Drop	WP
	Dash	Dash	mm	in	Dash Size	Dash Size				
1203198	-4848	48	76,0	3"	48	3	101,6	149,3	140,0	2000
1214145	-6464	64	102,0	4"	64	4	127,0	187,4	190,0	525



## // ALFACRIMP // C126

// JIC 37° INSERTS .....	186	// SAE FLANGES .....	190
// NPTF INSERTS .....	187	// SUPERCAT FLANGES .....	192
// API INSERTS.....	188	// HAMMER UNION.....	194
// ORFS INSERTS .....	189		

## // JIC 37° INSERTS

### // C12626512

**JIC Female 37° Seat with Stem Hexagon  
DKJ**

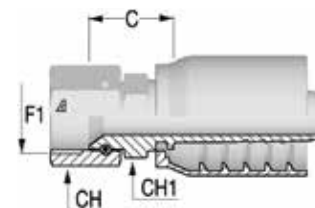

Item Code	Tale/Head	Nut Type	ID			F1		C	CH	CH1
	Dash		Dash	mm	in	Dash Size	F1			
1216077	-1212	TN	12	19,0	3/4"	12	1 1/16-12	30,2	27,0	32,0
1216080	-1616	TN	16	25,0	1"	16	1 5/16-12	38,0	36,0	38,0
1216082	-2020	TN	20	32,0	1 1/4"	20	1 5/8-12	43,1	41,0	50,0
1216084	-2424	TN	24	38,0	1 1/2"	24	1 7/8-12	49,4	50,0	55,0
1216085	-3232	TN	32	51,0	2"	32	2 1/2-12	49,0	65,0	70,0

### // C12622542

**45° JIC Female 37° Seat  
DKJ 45  
Solid one piece**

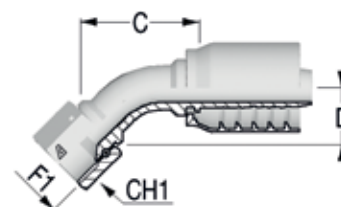

Item Code	Tale/Head	Nut Type	ID			F1		C	D Drop	CH1
	Dash		Dash	mm	in	Dash Size	F1			
1216067	-1212	TN	12	19,0	3/4"	12	1 1/16-12	66,0	27,5	32,0
1216068	-1616	TN	16	25,0	1"	16	1 5/16-12	79,5	31,0	38,0
1216069	-2020	TN	20	32,0	1 1/4"	20	1 5/8-12	93,7	37,0	50,0
1216070	-2424	TN	24	38,0	1 1/2"	24	1 7/8-12	107,0	43,5	55,0
1233046	-3232	TN	32	51,0	2"	32	2 1/2-12	147,0	51,5	70,0

### // C12622592

**90° JIC Female 37° Seat  
DKJ 90  
Solid one piece**

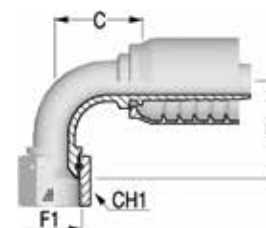

Item Code	Tale/Head	Nut Type	ID			F1		C	D Drop	CH1
	Dash		Dash	mm	in	Dash Size	F1			
1216071	-1212	TN	12	19,0	3/4"	12	1 1/16-12	45,0	57,0	32,0
1216074	-1616	TN	16	25,0	1"	16	1 5/16-12	71,0	67,0	38,0
1216076	-2020	TN	20	32,0	1 1/4"	20	1 5/8-12	79,2	78,0	50,0
1214175	-2424	TN	24	38,0	1 1/2"	24	1 7/8-12	94,5	92,0	55,0
1233047	-3232	TN	32	51,0	2"	32	2 1/2-12	132,0	135,0	70,0

Dimensions shown may be changed without prior notice

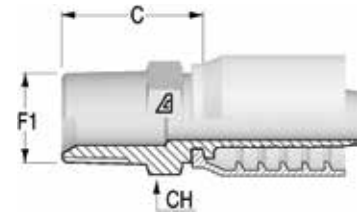
**// NPTF INSERTS****// C12612810****NPTF Male 60° Seat  
AGN**

Item Code	Tale/Head	Nut Type	ID			F1	F1	C	CH
	Dash		Dash	mm	in	Dash Size		mm	mm
1216038	-1212	NA	12	19,0	3/4"	12	3/4-14	35,5	27,0
1216039	-1616	NA	16	25,0	1"	16	1-11 1/2	46,5	36,0
1216040	-2020	NA	20	32,0	1 1/4"	20	1 1/4-11 1/2	52,0	46,0
1216041	-2424	NA	24	38,0	1 1/2"	24	1 1/2-11 1/2	55,5	50,0
1240065	-3232	NA	32	51,0	2"	32	2-11 1/2	-	65,0

## // API INSERTS

## // C1261281Z

API Male

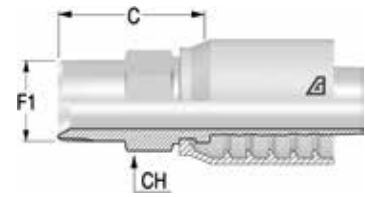

Item Code	Tale/Head	Nut Type	ID			F1	F1	C	CH
	Dash		Dash	mm	in	Dash Size		mm	mm
1230458	-3232	NA	32	51,0	2"	32	2-11 1/2	113,5	65,0

Dimensions shown may be changed without prior notice

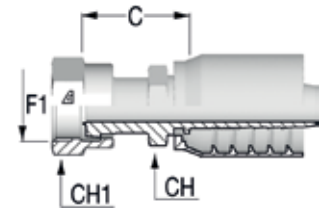
**// ORFS INSERTS****// C12622411****ORFS Female with Stem Hexagon**

Item Code	Tale/Head Dash	Nut Type	ID			F1		C	CH	CH1
			Dash	mm	in	Dash Size	F1			
1214173	-1212	CR	12	19,0	3/4"	12	1 3/16-12	40,0	30,0	36,0
1214174	-1216	CR	12	19,0	3/4"	16	1 7/16-12	43,0	36,0	41,0
1216051	-1616	CR	16	25,0	1"	16	1 7/16-12	47,0	36,0	41,0
1216052	-1620	CR	16	25,0	1"	20	1 11/16-12	49,0	46,0	50,0
1216053	-2020	CR	20	32,0	1 1/4"	20	1 11/16-12	47,2	46,0	50,0

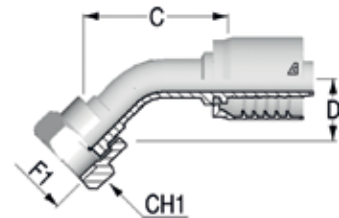
**// C12622441****45° ORFS Female  
DK ORFS 45  
Solid one piece**

Item Code	Tale/Head Dash	Nut Type	ID			F1		C	D Drop	CH1
			Dash	mm	in	Dash Size	F1			
1216055	-1212	CR	12	19,0	3/4"	12	1 3/16-12	77,7	26,0	36,0
1216056	-1216	CR	12	19,0	3/4"	16	1 7/16-12	68,4	28,0	41,0
1216057	-1616	CR	16	25,0	1"	16	1 7/16-12	114,0	28,0	41,0

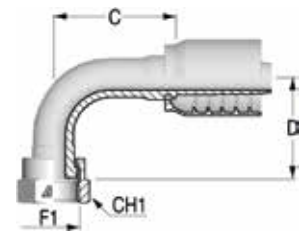
**// C12622491****90° ORFS Female  
DK ORFS 90  
Solid one piece**

Item Code	Tale/Head Dash	Nut Type	ID			F1		C	D Drop	CH1
			Dash	mm	in	Dash Size	F1			
1216059	-1212	CR	12	19,0	3/4"	12	1 3/16-12	64,2	58,0	36,0
1216060	-1216	CR	12	19,0	3/4"	16	1 7/16-12	66,2	58,0	41,0
1216061	-1616	CR	16	25,0	1"	16	1 7/16-12	75,2	66,0	41,0
1216062	-2020	CR	20	32,0	1 1/4"	20	1 11/16-12	91,7	81,0	50,0

## // SAE FLANGES

## // C12643310

Flange SAE 3000 PSI J518 Code 61 - SFL

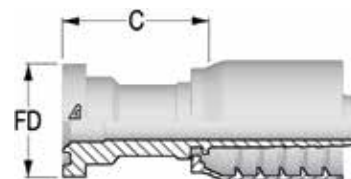

Item Code	Tale/Head		ID		Flange		C	FD	WP
	Dash	Dash	mm	in	Dash Size	Flange Size			
1216086	-1212	12	19,0	3/4"	12	3/4	43,5	38,1	5000
1216087	-1216	12	19,0	3/4"	16	1	51,5	44,5	5000
1216088	-1616	16	25,0	1"	16	1	53,5	44,5	5000
1216089	-1620	16	25,0	1"	20	1 1/4	56,0	50,8	4000
1216091	-2020	20	32,0	1 1/4"	20	1 1/4	58,5	50,8	4000
1216093	-2424	24	38,0	1 1/2"	24	1 1/2	63,5	60,3	3000
1216094	-2432	24	38,0	1 1/2"	32	2	75,0	71,4	3000
1237793	-3232	32	51,0	2"	32	2	85,0	71,4	3000

## // C12643610

Flange SAE 6000 PSI J518 Code 62 - SFS

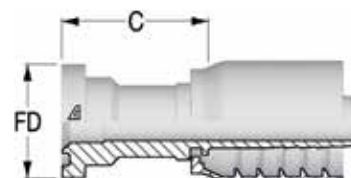

Item Code	Tale/Head		ID		Flange		C	FD	WP
	Dash	Dash	mm	in	Dash Size	Flange Size			
1216120	-1212	12	19,0	3/4"	12	3/4	50,0	41,3	6000
1216121	-1216	12	19,0	3/4"	16	1	53,0	47,6	6000
1216123	-1616	16	25,0	1"	16	1	54,0	47,6	6000
1216124	-1620	16	25,0	1"	20	1 1/4	61,0	54,0	6000
1216125	-2020	20	32,0	1 1/4"	20	1 1/4	62,2	54,0	6000
1216126	-2024	20	32,0	1 1/4"	24	1 1/2	68,2	63,5	6000
1216127	-2424	24	38,0	1 1/2"	24	1 1/2	68,5	63,5	6000
1216128	-2432	24	38,0	1 1/2"	32	2	80,5	79,4	6000
1216129	-3232	32	51,0	2"	32	2	87,0	79,4	6000

Dimensions shown may be changed without prior notice

## // C12643640

45° Flange SAE 6000 PSI J518 Code 62 - SFS 45  
Solid one piece

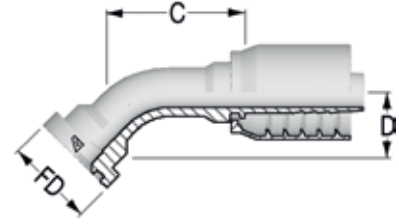

Item Code	Tale/Head		ID		Flange		FD	C	D Drop	WP
	Dash	Dash	mm	in	Dash Size	Flange Size				
1216140	-1212	12	19,0	3/4"	12	3/4	41,3	72,1	30,0	6000
1216141	-1216	12	19,0	3/4"	16	1	47,6	76,8	33,0	6000
1216142	-1616	16	25,0	1"	16	1	47,6	94,8	38,5	6000
1216143	-1620	16	25,0	1"	20	1 1/4	54,0	105,3	44,0	6000
1216144	-2020	20	32,0	1 1/4"	20	1 1/4	54,0	102,0	41,0	6000
1216145	-2024	20	32,0	1 1/4"	24	1 1/2	63,5	111,7	48,0	6000
1216146	-2424	24	38,0	1 1/2"	24	1 1/2	63,5	136,3	48,0	6000
1216147	-2432	24	38,0	1 1/2"	32	2	79,4	129,1	55,0	6000
1216148	-3232	32	51,0	2"	32	2	79,4	160,6	61,0	6000

## // C12643690

90° Flange SAE 6000 PSI J518 Code 62 - SFS 90  
Solid one piece

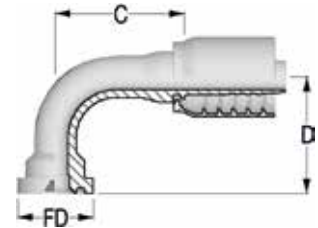

Item Code	Tale/Head		ID		Flange		FD	C	D Drop	WP
	Dash	Dash	mm	in	Dash Size	Flange Size				
1216154	-1212	12	19,0	3/4"	12	3/4	41,3	61,2	64,0	6000
1216155	-1216	12	19,0	3/4"	16	1	47,6	61,2	66,0	6000
1216157	-1616	16	25,0	1"	16	1	47,6	70,4	74,0	6000
1216158	-1620	16	25,0	1"	20	1 1/4	54,0	77,2	85,0	6000
1216159	-2020	20	32,0	1 1/4"	20	1 1/4	54,0	88,2	91,0	6000
1216160	-2024	20	32,0	1 1/4"	24	1 1/2	63,5	92,9	103,5	6000
1216161	-2420	24	38,0	1 1/2"	20	1 1/4	54,0	105,0	85,0	6000
1216162	-2424	24	38,0	1 1/2"	24	1 1/2	63,5	106,3	109,0	6000
1216163	-2432	24	38,0	1 1/2"	32	2	79,4	106,5	121,5	6000
1216164	-3232	32	51,0	2"	32	2	79,4	172,0	131,0	6000



## // SUPERCAT FLANGES

## // C12643910

## Flange SUPERCAT

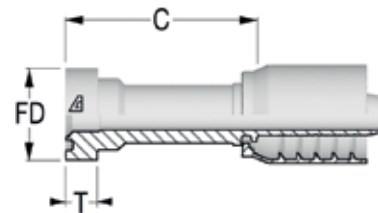

Item Code	Tale/Head		ID		Flange		FD	T	C
	Dash	Dash	mm	in	Dash Size	Flange Size			
1216165	-1212	12	19,0	3/4"	12	3/4	41,3	14,3	82,0
1216166	-1216	12	19,0	3/4"	16	1	47,6	14,3	82,0
1216167	-1616	16	25,0	1"	16	1	47,6	14,3	90,0
1216168	-1620	16	25,0	1"	20	1 1/4	54,0	14,3	90,0
1216169	-2020	20	32,0	1 1/4"	20	1 1/4	54,0	14,3	86,2
1216170	-2424	24	38,0	1 1/2"	24	1 1/2	63,5	14,3	89,0

## // C12643930

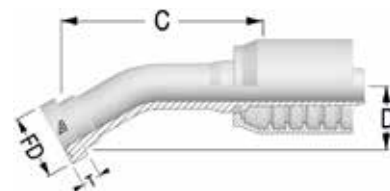
30° Flange SUPERCAT  
Solid one piece

Item Code	Tale/Head		ID		Flange		FD	T	C	D Drop
	Dash	Dash	mm	in	Dash Size	Flange Size				
1216173	-1212	12	19,0	3/4"	12	3/4	41,3	14,3	115,0	24,0
1216174	-1216	12	19,0	3/4"	16	1	47,6	14,3	118,0	26,5
1233049	-1616	16	25,0	1"	16	1	47,6	14,3	139,0	27,0
1233050	-1620	16	25,0	1"	20	1 1/4	54,0	14,3	137,0	25,5

## // C12643940

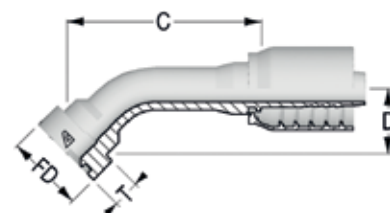
45° Flange SUPERCAT  
Solid one piece

Item Code	Tale/Head		ID		Flange		FD	T	C	D Drop
	Dash	Dash	mm	in	Dash Size	Flange Size				
1216177	-1212	12	19,0	3/4"	12	3/4	41,3	14,3	103,0	33,7
1216178	-1216	12	19,0	3/4"	16	1	47,6	14,3	87,4	35,8
1216179	-1616	16	25,0	1"	16	1	47,6	14,3	93,9	42,5
1216180	-1620	16	25,0	1"	20	1 1/4	54,0	14,3	95,4	40,0
1216181	-2020	20	32,0	1 1/4"	20	1 1/4	54,0	14,3	103,6	45,1

Dimensions shown may be changed without prior notice

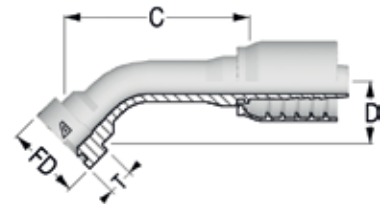
**// C12643960****60° Flange SUPERCAT**  
**Solid one piece**

Item Code	Tale/Head		ID		Flange		FD	T	C	D Drop
	Dash	Dash	mm	in	Dash Size	Flange Size				
1216182	-1212	12	19,0	3/4"	12	3/4	41,3	14,3	92,6	46,0
1216183	-1216	12	19,0	3/4"	16	1	47,6	14,3	95,6	48,5
1216184	-1616	16	25,0	1"	16	1	47,6	14,3	118,0	59,0
1216185	-1620	16	25,0	1"	20	1 1/4	54,0	14,3	118,0	57,0

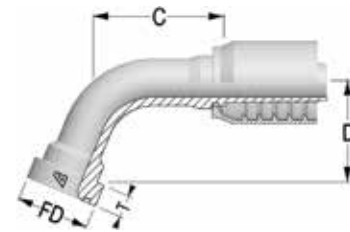
**// C12643970****67,5° Flange SUPERCAT**  
**Solid one piece**

Item Code	Tale/Head		ID		Flange		FD	T	C	D Drop
	Dash	Dash	mm	in	Dash Size	Flange Size				
1216193	-1212	12	19,0	3/4"	12	3/4	41,3	14,3	86,1	51,8
1216194	-1216	12	19,0	3/4"	16	1	47,6	14,3	88,8	54,6
1233051	-1616	16	25,0	1"	16	1	47,6	14,3	111,0	67,0
1233052	-1620	16	25,0	1"	20	1 1/4	54,0	14,3	109,0	64,0
1233053	-2020	20	32,0	1 1/4"	20	1 1/4	54,0	14,3	119,3	70,6

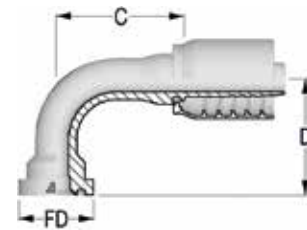
**// C12643990****90° Flange SUPERCAT**  
**Solid one piece**

Item Code	Tale/Head		ID		Flange		FD	T	C	D Drop
	Dash	Dash	mm	in	Dash Size	Flange Size				
1216188	-1212	12	19,0	3/4"	12	3/4	41,3	14,3	63,7	67,0
1216189	-1216	12	19,0	3/4"	16	1	47,6	14,3	65,2	70,0
1216190	-1616	16	25,0	1"	16	1	47,6	14,3	80,4	79,0
1216192	-1620	16	25,0	1"	20	1 1/4	54,0	14,3	75,4	82,5
1233054	-2020	20	32,0	1 1/4"	20	1 1/4	54,0	14,3	89,2	93,0

## // HAMMER UNION

## // C12R13F13

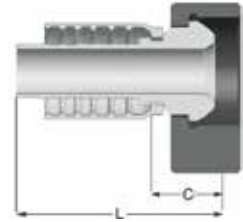
**Male Hammer Union Fig. 1502 Integral Fitting with Lug Nut**

Item Code	Tale/Head		ID		C	L
	Dash	Dash	mm	in	mm	mm
1237779	-3232	32	51,0	2"	60,0	185,50

## // C12R23F10

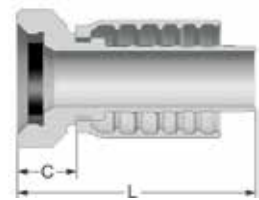
**Female Hammer Union Fig. 1502 Integral Fitting with Rubber Ring**

Item Code	Tale/Head		ID		C	L
	Dash	Dash	mm	in	mm	mm
1237786	-3232	32	51,0	2"	56,5	182,00



## // JIC 37° ADAPTERS

// PLUG.....	196	// METRIC.....	216
// MALE UNION .....	197	// SAE UNF .....	222
// MALE / FEMALE UNION .....	199	// NPTF.....	230
// BULKHEAD .....	202	// ACCESSORIES.....	233
// BSPP.....	205	// FLANGES .....	234

# // PLUG

## // R1A2531000 Cap JIC Female

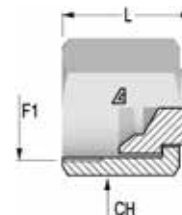

Item Code	Head	OD1	F1	CH	L
	Dash			mm	mm
1207348	-0400	1/4"	7/16-20	14,0	17,0
1207349	-0500	5/16"	1/2-20	17,0	19,5
1207350	-0600	3/8"	9/16-18	19,0	20,5
1207351	-0800	1/2"	3/4-16	22,0	24,0
1207352	-1000	5/8"	7/8-14	27,0	27,0
1207353	-1200	3/4"	1 1/16-12	32,0	31,5
1213213	-1400	7/8"	1 3/16-12	36,0	32,0
1207354	-1600	1"	1 5/16-12	41,0	32,5
1207355	-2000	1 1/4"	1 5/8-12	50,0	35,5
1207356	-2400	1 1/2"	1 7/8-12	60,0	43,0

## // R1A25M1000 Plug JIC Male

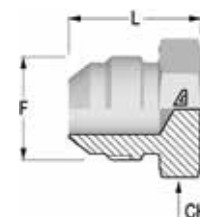

Item Code	Head	OD1	F1	CH	L
	Dash			mm	mm
1207449	-0400	1/4"	7/16-20	12,0	20,5
1207450	-0500	5/16"	1/2-20	14,0	20,5
1207451	-0600	3/8"	9/16-18	14,0	21,5
1207452	-0800	1/2"	3/4-16	22,0	24,0
1207453	-1000	5/8"	7/8-14	24,0	28,0
1207454	-1200	3/4"	1 1/16-12	30,0	32,5
1212825	-1400	7/8"	1 3/16-12	33,0	33,0
1207455	-1600	1"	1 5/16-12	36,0	34,0
1207456	-2000	1 1/4"	1 5/8-12	46,0	37,0
1207457	-2400	1 1/2"	1 7/8-12	50,0	42,0

Dimensions shown may be changed without prior notice

## // MALE UNION

## // R1A25M125M

Straight union JIC - JIC Male

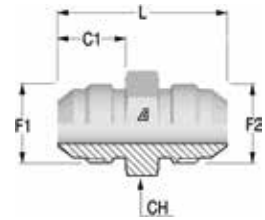

Item Code	Head 1 / Head 2	OD1	F1	C1	CH	L
	Dash	in		mm	mm	mm
1203685	-0404	1/4"	7/16-20	14,0	12,0	35,0
1203628	-0505	5/16"	1/2-20	14,0	14,0	35,0
1203713	-0606	3/8"	9/16-18	14,0	17,0	36,0
1203670	-0808	1/2"	3/4-16	16,5	22,0	41,0
1203698	-1010	5/8"	7/8-14	19,5	24,0	48,0
1203616	-1212	3/4"	1 1/16-12	22,0	30,0	55,0
1216393	-1414	7/8"	1 3/16-12	22,5	32,0	56,5
1203639	-1616	1"	1 5/16-12	23,0	36,0	57,0
1203646	-2020	1"1/4	1 5/8-12	24,5	46,0	61,5
1203653	-2424	1"1/2	1 7/8-12	27,5	50,0	70,0

## // R1A25M925M

90° union JIC - JIC Male

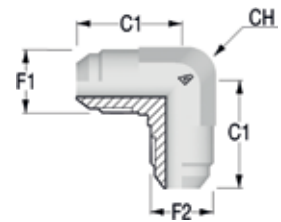

Item Code	Head 1 / Head 2	OD1	F1	C1	CH
	Dash	in		mm	mm
1203876	-0404	1/4"	7/16-20	22,5	12,0
1203842	-0505	5/16"	1/2-20	24,0	14,0
1203897	-0606	3/8"	9/16-18	27,0	14,0
1203866	-0808	1/2"	3/4-16	32,0	19,0
1203884	-1010	5/8"	7/8-14	37,0	22,0
1203836	-1212	3/4"	1 1/16-12	42,0	27,0
1216421	-1414	7/8"	1 3/16-12	44,0	33,0
1203849	-1616	1"	1 5/16-12	46,0	33,0
1203855	-2020	1"1/4	1 5/8-12	52,5	41,0
1206334	-2424	1"1/2	1 7/8-12	59,0	48,0

**// R1A25MT25M**

**Tee union JIC - JIC Male**

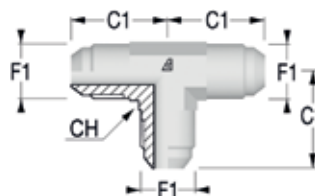

Item Code	Head 1 / Head 2	OD1	F1	C1	CH
	Dash	in		mm	mm
1203950	-0404	1/4"	7/16-20	22,5	12,0
1203945	-0505	5/16"	1/2-20	24,0	14,0
1203954	-0606	3/8"	9/16-18	27,0	14,0
1203948	-0808	1/2"	3/4-16	32,0	19,0
1203952	-1010	5/8"	7/8-14	37,0	22,0
1203944	-1212	3/4"	1 1/16-12	42,0	27,0
1216460	-1414	7/8"	1 3/16-12	44,0	33,0
1203947	-1616	1"	1 5/16-12	46,0	33,0
1205959	-2020	1"1/4	1 5/8-12	52,5	41,0
1206335	-2424	1"1/2	1 7/8-12	59,0	48,0

**// R1A25MX25M**

**Cross union JIC - JIC Male**

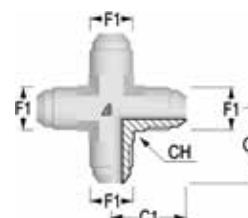

Item Code	Head 1 / Head 2	OD1	F1	C1	CH
	Dash	in		mm	mm
1206909	-0404	1/4"	7/16-20	22,5	12,0
1205451	-0505	5/16"	1/2-20	24,0	14,0
1205455	-0606	3/8"	9/16-18	27,0	14,0
1205453	-0808	1/2"	3/4-16	32,0	19,0
1205454	-1010	5/8"	7/8-14	37,0	22,0
1206835	-1212	3/4"	1 1/16-12	42,0	27,0
1216494	-1414	7/8"	1 3/16-12	44,0	33,0
1205452	-1616	1"	1 5/16-12	46,0	33,0
1212823	-2020	1"1/4	1 5/8-12	52,5	41,0
1212824	-2424	1"1/2	1 7/8-12	59,0	48,0

Dimensions shown may be changed without prior notice

## // MALE / FEMALE UNION

### // R1A253125M

Straight reducing JIC Female - JIC Male

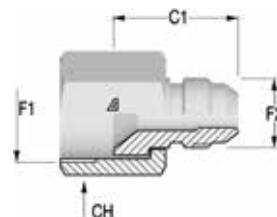

Item Code	Head 1 / Head 2	OD1 in	F1	F2	C1 mm	CH mm
	Dash					
1207357	-0604	3/8"	9/16-18	7/16-20	25,0	19,0
1207615	-0605	3/8"	9/16-18	1/2-20	25,0	19,0
1207358	-0804	1/2"	3/4-16	7/16-20	25,5	22,0
1207359	-0805	1/2"	3/4-16	1/2-20	25,5	22,0
1207360	-0806	1/2"	3/4-16	9/16-18	25,5	22,0
1207361	-1004	5/8"	7/8-14	7/16-20	26,5	27,0
1207362	-1006	5/8"	7/8-14	9/16-18	26,5	27,0
1207616	-1008	5/8"	7/8-14	3/4-16	29,0	27,0
1207363	-1204	3/4"	1 1/16-12	7/16-20	27,0	32,0
1207364	-1206	3/4"	1 1/16-12	9/16-18	27,0	32,0
1207365	-1208	3/4"	1 1/16-12	3/4-16	30,5	32,0
1207617	-1210	3/4"	1 1/16-12	7/8-14	34,5	32,0
1216344	-1412	7/8"	1 3/16-12	1 1/16-12	36,4	36,0
1216365	-1606	1"	1 5/16-12	9/16-18	28,5	41,0
1216366	-1608	1"	1 5/16-12	3/4-16	31,0	41,0
1208272	-1610	1"	1 5/16-12	7/8-14	34,0	41,0
1207367	-1612	1"	1 5/16-12	1 1/16-12	37,5	41,0
1213168	-1614	1"	1 5/16-12	1 3/16-12	39,5	38,0
1207366	-2012	1 1/4"	1 5/8-12	1 1/16-12	39,1	50,0
1207368	-2016	1 1/4"	1 5/8-12	1 5/16-12	40,0	50,0
1216367	-2416	1 1/2"	1 7/8-12	1 5/16-12	46,3	60,0
1207369	-2420	1 1/2"	1 7/8-12	1 5/8-12	47,8	60,0

### // R1A25M4251

45° union JIC Male - JIC Female

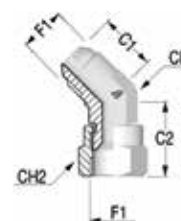

Item Code	Head 1 / Head 2	OD1 in	F1	C1	C2	CH mm	CH2 mm
	Dash			mm	mm		
1207343	-0404	1/4"	7/16-20	18,5	23,7	12,0	16,0
1207342	-0505	5/16"	1/2-20	19,5	25,5	14,0	17,0
1207341	-0606	3/8"	9/16-18	21,5	28,5	14,0	19,0
1207344	-0808	1/2"	3/4-16	24,5	32,7	19,0	25,0
1206944	-1010	5/8"	7/8-14	28,0	36,7	22,0	27,0
1207345	-1212	3/4"	1 1/16-12	32,5	38,3	27,0	32,0
1216410	-1414	7/8"	1 3/16-12	35,4	41,1	33,0	36,0
1207346	-1616	1"	1 5/16-12	36,5	44,6	33,0	38,0
1207347	-2020	1 1/4"	1 5/8-12	40,5	51,4	41,0	50,0
1210765	-2424	1 1/2"	1 7/8-12	45,0	57,1	48,0	55,0



**// R1A25M9251**

**90° union JIC Male - JIC Female**

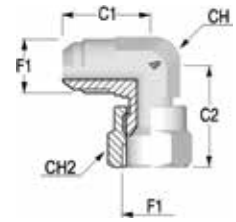

Item Code	Head 1 / Head 2	OD1 in	F1	C1	C2	CH	CH2
	Dash			mm	mm	mm	mm
1207266	-0404	1/4"	7/16-20	22,5	25,2	12,0	16,0
1207267	-0505	5/16"	1/2-20	24,0	27,0	14,0	17,0
1207268	-0606	3/8"	9/16-18	27,0	32,0	14,0	19,0
1207269	-0808	1/2"	3/4-16	32,0	35,2	19,0	25,0
1207270	-1010	5/8"	7/8-14	36,5	41,5	22,0	27,0
1207271	-1212	3/4"	1 1/16-12	42,0	44,3	27,0	32,0
1216420	-1414	7/8"	1 3/16-12	45,5	46,5	33,0	36,0
1207272	-1616	1"	1 5/16-12	46,0	50,5	33,0	38,0
1207273	-2020	1 1/4"	1 5/8-12	52,5	58,9	41,0	50,0
1207274	-2424	1 1/2"	1 7/8-12	59,0	65,6	48,0	55,0

**// R1A25MT251**

**Branch Tee union JIC Male - JIC Female**

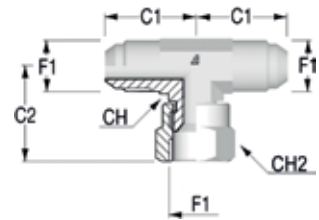

Item Code	Head 1 / Head 2	OD1 in	F1	C1	C2	CH	CH2
	Dash			mm	mm	mm	mm
1207304	-0404	1/4"	7/16-20	22,5	22,5	12,0	-
1207305	-0505	5/16"	1/2-20	24,0	24,0	14,0	-
1207306	-0606	3/8"	9/16-18	27,0	27,0	14,0	-
1207307	-0808	1/2"	3/4-16	32,0	32,0	19,0	-
1207308	-1010	5/8"	7/8-14	36,5	36,5	22,0	-
1207309	-1212	3/4"	1 1/16-12	42,0	42,0	27,0	-
1216459	-1414	7/8"	1 3/16-12	45,5	45,5	33,0	-
1207310	-1616	1"	1 5/16-12	46,0	46,0	33,0	-
1207311	-2020	1 1/4"	1 5/8-12	52,5	52,5	41,0	-
1207312	-2424	1 1/2"	1 7/8-12	59,0	59,0	48,0	-

Dimensions shown may be changed without prior notice

## // R1A25ML251

## Run Tee union JIC Male - JIC Female

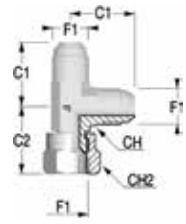

Item Code	Head 1 / Head 2	OD1	F1	C1	C2	CH	CH2
	Dash	in		mm	mm	mm	mm
1207283	-0404	1/4"	7/16-20	22,5	25,2	12,0	16,0
1207284	-0505	5/16"	1/2-20	24,0	27,0	14,0	17,0
1207285	-0606	3/8"	9/16-18	27,0	32,0	14,0	19,0
1207286	-0808	1/2"	3/4-16	32,0	35,2	19,0	25,0
1207287	-1010	5/8"	7/8-14	36,5	41,5	22,0	27,0
1207288	-1212	3/4"	1 1/16-12	42,0	44,3	27,0	32,0
1216434	-1414	7/8"	1 3/16-12	45,5	46,5	33,0	36,0
1207289	-1616	1"	1 5/16-12	46,0	50,5	33,0	38,0
1207290	-2020	1"1/4	1 5/8-12	52,5	58,9	41,0	50,0
1207291	-2424	1"1/2	1 7/8-12	59,0	65,6	48,0	55,0

# // BULKHEAD

## // R1A25M125T

Straight union JIC - JIC Bulkhead

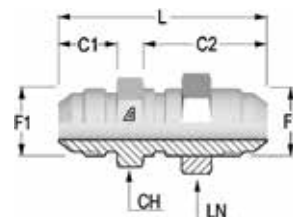

Item Code	Head 1 / Head 2	OD1	F1	C1	C2	CH	LN	L
	Dash	in		mm	mm			
1203686	-0404	1/4"	7/16-20	14,0	30,5	17,0	17,0	52,5
1203629	-0505	5/16"	1/2-20	14,0	30,5	19,0	19,0	52,5
1203714	-0606	3/8"	9/16-18	14,0	32,5	22,0	22,0	55,5
1203671	-0808	1/2"	3/4-16	16,5	36,6	24,0	24,0	62,0
1203699	-1010	5/8"	7/8-14	19,5	40,1	30,0	30,0	69,5
1203617	-1212	3/4"	1 1/16-12	22,0	44,4	36,0	36,0	78,5
1216394	-1414	7/8"	1 3/16-12	22,5	44,4	38,0	38,0	79,2
1203640	-1616	1"	1 5/16-12	23,0	44,4	41,0	41,0	80,0
1203647	-2020	1 1/4"	1 5/8-12	24,5	45,7	50,0	50,0	84,0
1211675	-2424	1 1/2"	1 7/8-12	27,5	46,0	55,0	55,0	89,5

## // R1A25M425T

45° union JIC - JIC Bulkhead

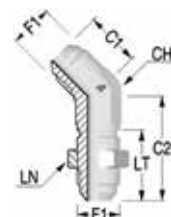

Item Code	Head 1 / Head 2	OD1	F1	C1	C2	CH	LN	LT
	Dash	in		mm	mm			
1210766	-0404	1/4"	7/16-20	18,5	39,0	12,0	17,0	30,5
1211706	-0505	5/16"	1/2-20	19,5	42,0	14,0	19,0	30,5
1208045	-0606	3/8"	9/16-18	21,0	42,5	14,0	22,0	32,5
1210767	-0808	1/2"	3/4-16	25,0	49,5	19,0	24,0	36,6
1210768	-1010	5/8"	7/8-14	28,0	55,0	22,0	30,0	40,1
1210769	-1212	3/4"	1 1/16-12	32,5	62,0	27,0	36,0	44,4
1216411	-1414	7/8"	1 3/16-12	35,0	63,5	33,0	38,0	44,4
1210770	-1616	1"	1 5/16-12	37,5	65,0	33,0	41,0	44,4
1211707	-2020	1 1/4"	1 5/8-12	40,5	67,5	41,0	50,0	45,7
1211708	-2424	1 1/2"	1 7/8-12	45,0	68,0	48,0	55,0	46,0

Dimensions shown may be changed without prior notice

## // R1A25M925T

### 90° union JIC - JIC Bulkhead

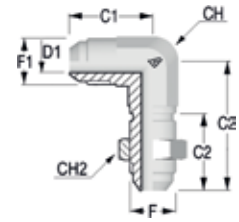

Item Code	Head 1 / Head 2	OD1	F1	C1	C2	CH	LN	LT
	Dash	in		mm	mm	mm		
1205564	-0404	1/4"	7/16-20	24,5	40,5	12,0	17,0	30,5
1206405	-0505	5/16"	1/2-20	27,0	43,5	14,0	19,0	30,5
1203898	-0606	3/8"	9/16-18	27,5	46,0	14,0	22,0	32,5
1203867	-0808	1/2"	3/4-16	34,5	53,5	19,0	24,0	36,6
1203885	-1010	5/8"	7/8-14	39,5	60,5	22,0	30,0	40,1
1206783	-1212	3/4"	1 1/16-12	45,0	68,0	27,0	36,0	44,4
1216422	-1414	7/8"	1 3/16-12	47,0	69,0	33,0	38,0	44,4
1211735	-1616	1"	1 5/16-12	49,5	71,0	33,0	41,0	44,4
1211736	-2020	1 1/4"	1 5/8-12	55,0	79,0	41,0	50,0	45,7
1208117	-2424	1 1/2"	1 7/8-12	59,5	87,0	48,0	55,0	46,0

## // R1A25MT25T

### Branch Tee union JIC - JIC Bulkhead

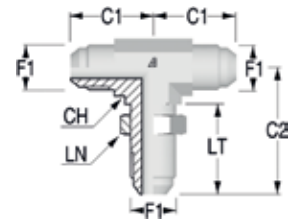

Item Code	Head 1 / Head 2	OD1	F1	C1	C2	CH	LN	LT
	Dash	in		mm	mm	mm		
1208139	-0404	1/4"	7/16-20	24,5	24,5	12,0	17,0	30,5
1210747	-0505	5/16"	1/2-20	27,0	27,0	14,0	19,0	30,5
1210748	-0606	3/8"	9/16-18	27,5	27,5	14,0	22,0	32,5
1205586	-0808	1/2"	3/4-16	34,5	34,5	19,0	24,0	36,6
1211637	-1010	5/8"	7/8-14	39,5	39,5	22,0	30,0	40,1
1211638	-1212	3/4"	1 1/16-12	45,0	45,0	27,0	36,0	44,4
1216462	-1414	7/8"	1 3/16-12	47,0	47,0	33,0	38,0	44,4
1212775	-1616	1"	1 5/16-12	49,5	49,5	33,0	41,0	44,4
1208225	-2020	1 1/4"	1 5/8-12	55,0	55,0	41,0	50,0	45,7
1212776	-2424	1 1/2"	1 7/8-12	59,5	59,5	48,0	55,0	46,0

**// R1A25ML25T**

**Run Tee union JIC - JIC Bulkhead**

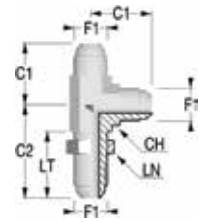

Item Code	Head 1 / Head 2	OD1 in	F1	C1	C2	CH	LN	LT
	Dash			mm	mm	mm	mm	mm
1211617	-0404	1/4"	7/16-20	24,5	40,5	12,0	17,0	30,5
1211618	-0505	5/16"	1/2-20	27,0	43,5	14,0	19,0	30,5
1206974	-0606	3/8"	9/16-18	27,5	46,0	14,0	22,0	32,5
1211619	-0808	1/2"	3/4-16	34,5	53,5	19,0	24,0	36,6
1210743	-1010	5/8"	7/8-14	39,5	60,5	22,0	30,0	40,1
1211620	-1212	3/4"	1 1/16-12	45,0	68,0	27,0	36,0	44,4
1216435	-1414	7/8"	1 3/16-12	47,0	69,0	33,0	38,0	44,4
1212713	-1616	1"	1 5/16-12	49,5	71,0	33,0	41,0	44,4
1212714	-2020	1 1/4"	1 5/8-12	55,0	79,0	41,0	50,0	45,7
1212715	-2424	1 1/2"	1 7/8-12	59,5	87,0	48,0	55,0	46,0

Dimensions shown may be changed without prior notice

// BSPP

// R1A25M105M

Straight connector JIC Male - BSPP cylindric Male 60°

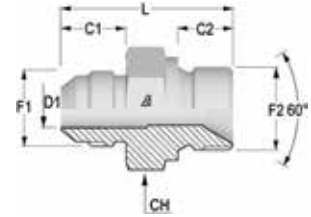

Item Code	Head 1 / Head 2	OD1 in	F1	F2	C1	C2	CH mm	L mm
	Dash				mm	mm		
1212826	-0402	1/4"	7/16-20	1/8-28	14,0	9,5	14,0	29,0
1212827	-0404	1/4"	7/16-20	1/4-19	14,0	13,0	19,0	34,0
1212828	-0406	1/4"	7/16-20	3/8-19	14,0	15,5	22,0	35,5
1212829	-0408	1/4"	7/16-20	1/2-14	14,0	17,0	27,0	40,0
1212830	-0502	5/16"	1/2-20	1/8-28	14,0	9,5	14,0	29,0
1212831	-0504	5/16"	1/2-20	1/4-19	14,0	13,0	19,0	32,0
1212832	-0604	3/8"	9/16-18	1/4-19	14,0	13,0	19,0	34,0
1212833	-0606	3/8"	9/16-18	3/8-19	14,0	15,5	22,0	35,5
1212834	-0608	3/8"	9/16-18	1/2-14	14,0	17,0	27,0	41,0
1212835	-0804	1/2"	3/4-16	1/4-19	16,5	13,0	19,0	36,0
1207735	-0806	1/2"	3/4-16	3/8-19	16,5	15,5	22,0	38,0
1207736	-0808	1/2"	3/4-16	1/2-14	16,5	17,0	27,0	41,0
1207737	-0812	1/2"	3/4-16	3/4-14	16,5	20,0	32,0	45,5
1207738	-1006	5/8"	7/8-14	3/8-19	19,5	15,5	24,0	41,5
1205996	-1008	5/8"	7/8-14	1/2-14	19,5	17,0	27,0	45,5
1231525	-1012	5/8"	7/8-14	3/4-14	19,5	20,0	32,0	48,5
1212837	-1208	3/4"	1 1/16-12	1/2-14	22,0	17,0	32,0	50,0
1212838	-1212	3/4"	1 1/16-12	3/4-14	22,0	20,0	32,0	50,0
1212839	-1216	3/4"	1 1/16-12	1-11	22,0	18,0	41,0	53,0
1216372	-1412	7/8"	1 3/16-12	3/4-14	22,5	20,0	32,0	51,5
1212840	-1612	1"	1 5/16-12	3/4-14	23,0	20,0	36,0	55,0
1212841	-1616	1"	1 5/16-12	1-11	23,0	22,0	41,0	54,0
1212842	-1620	1"	1 5/16-12	1 1/4-11	23,0	23,0	50,0	56,0
1207739	-2016	1 1/4"	1 5/8-12	1-11	24,5	22,0	46,0	58,5
1212843	-2020	1 1/4"	1 5/8-12	1 1/4-11	24,5	23,0	50,0	59,5
1212844	-2420	1 1/2"	1 7/8-12	1 1/4-11	27,5	23,0	50,0	62,5
1212845	-2424	1 1/2"	1 7/8-12	1 1/2-11	27,5	25,0	55,0	67,5

**// R1A25M106I**

**Straight connector JIC Male - BSPP cylindric Male with elastomer**

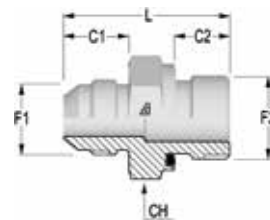

Item Code	Head 1 / Head 2	OD1 in	F1	F2	C1	C2	CH	L
	Dash				mm	mm		
1207410	-0402	1/4"	7/16-20	1/8-28	14,0	8,0	14,0	30,0
1207411	-0404	1/4"	7/16-20	1/4-19	14,0	12,0	19,0	36,0
1207412	-0406	1/4"	7/16-20	3/8-19	14,0	12,0	22,0	35,5
1207413	-0408	1/4"	7/16-20	1/2-14	14,0	14,0	27,0	39,0
1207993	-0502	5/16"	1/2-20	1/8-28	14,0	8,0	14,0	30,5
1207414	-0504	5/16"	1/2-20	1/4-19	14,0	12,0	19,0	35,0
1207415	-0506	5/16"	1/2-20	3/8-19	14,0	12,0	22,0	35,5
1207416	-0604	3/8"	9/16-18	1/4-19	14,0	12,0	19,0	35,0
1207417	-0606	3/8"	9/16-18	3/8-19	14,0	12,0	22,0	36,0
1207418	-0608	3/8"	9/16-18	1/2-14	14,0	14,0	27,0	39,5
1207419	-0804	1/2"	3/4-16	1/4-19	16,5	12,0	19,0	38,5
1207420	-0806	1/2"	3/4-16	3/8-19	16,5	12,0	22,0	38,5
1207421	-0808	1/2"	3/4-16	1/2-14	16,5	14,0	27,0	42,0
1207422	-0812	1/2"	3/4-16	3/4-14	16,5	17,0	32,0	45,5
1207423	-1006	5/8"	7/8-14	3/8-19	19,5	12,0	24,0	42,5
1207424	-1008	5/8"	7/8-14	1/2-14	19,5	14,0	27,0	44,5
1207425	-1012	5/8"	7/8-14	3/4-14	19,5	17,0	32,0	49,5
1207426	-1208	3/4"	1 1/16-12	1/2-14	22,0	14,0	32,0	49,0
1207427	-1212	3/4"	1 1/16-12	3/4-14	22,0	17,0	32,0	51,0
1207428	-1216	3/4"	1 1/16-12	1-11	22,0	18,0	41,0	53,5
1212875	-1412	7/8"	1 3/16-12	3/4-14	22,5	17,0	32,0	53,5
1207429	-1612	1"	1 5/16-12	3/4-14	23,0	17,0	36,0	51,5
1207430	-1616	1"	1 5/16-12	1-11	23,0	18,0	41,0	54,5
1207431	-1620	1"	1 5/16-12	1 1/4-11	23,0	20,0	50,0	58,4
1208006	-2016	1 1/4"	1 5/8-12	1-11	24,5	18,0	46,0	62,0
1207432	-2020	1 1/4"	1 5/8-12	1 1/4-11	24,5	20,0	50,0	60,0
1207433	-2420	1 1/2"	1 7/8-12	1 1/4-11	27,5	20,0	50,0	64,0
1207434	-2424	1 1/2"	1 7/8-12	1 1/2-11	27,5	22,0	55,0	67,0

Dimensions shown may be changed without prior notice

## // R1A25M106H

Long connector JIC Male - BSPP cylindric Male with elastomer

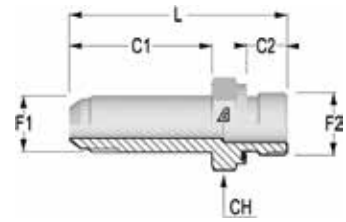

Item Code	Head 1 / Head 2	OD1 in	F1	F2	C1 mm	C2 mm	CH mm	L mm
	Dash							
1212846	-0402	1/4"	7/16-20	1/8-28	35,0	8,0	14,0	50,0
1212847	-0404	1/4"	7/16-20	1/4-19	35,0	12,0	19,0	55,5
1212848	-0406	1/4"	7/16-20	3/8-19	35,0	12,0	22,0	56,8
1212849	-0408	1/4"	7/16-20	1/2-14	35,0	14,0	27,0	60,3
1212850	-0502	5/16"	1/2-20	1/8-28	37,0	8,0	14,0	53,3
1212851	-0504	5/16"	1/2-20	1/4-19	37,0	12,0	19,0	57,5
1212852	-0506	5/16"	1/2-20	3/8-19	37,0	12,0	22,0	57,5
1212853	-0604	3/8"	9/16-18	1/4-19	39,0	12,0	19,0	59,5
1212854	-0606	3/8"	9/16-18	3/8-19	39,0	12,0	22,0	59,5
1212855	-0608	3/8"	9/16-18	1/2-14	39,0	14,0	27,0	63,0
1212856	-0804	1/2"	3/4-16	1/4-19	48,0	12,0	19,0	68,5
1212857	-0806	1/2"	3/4-16	3/8-19	48,0	12,0	22,0	68,5
1212858	-0808	1/2"	3/4-16	1/2-14	48,0	14,0	27,0	72,0
1212859	-0812	1/2"	3/4-16	3/4-14	48,0	17,0	32,0	77,0
1212860	-1006	5/8"	7/8-14	3/8-19	53,0	12,0	24,0	74,0
1212861	-1008	5/8"	7/8-14	1/2-14	53,0	14,0	27,0	77,0
1212862	-1012	5/8"	7/8-14	3/4-14	53,0	17,0	32,0	81,0
1212863	-1208	3/4"	1 1/16-12	1/2-14	63,0	14,0	32,0	88,0
1212864	-1212	3/4"	1 1/16-12	3/4-14	63,0	17,0	32,0	91,0
1212865	-1216	3/4"	1 1/16-12	1-11	63,0	18,0	41,0	93,5
1216388	-1412	7/8"	1 3/16-12	3/4-14	67,0	17,0	32,0	99,3
1212866	-1612	1"	1 5/16-12	3/4-14	72,0	17,0	36,0	100,0
1212867	-1616	1"	1 5/16-12	1-11	72,0	18,0	41,0	102,0
1212868	-1620	1"	1 5/16-12	1 1/4-11	72,0	20,0	50,0	106,0
1212869	-2016	1 1/4"	1 5/8-12	1-11	88,0	18,0	46,0	119,0
1212870	-2020	1 1/4"	1 5/8-12	1 1/4-11	88,0	20,0	50,0	122,0
1212871	-2420	1 1/2"	1 7/8-12	1 1/4-11	98,0	20,0	50,0	132,0
1212872	-2424	1 1/2"	1 7/8-12	1 1/2-11	98,0	22,0	55,0	136,0



**// R1A25M106H**

**Long connector JIC Male - BSPP cylindric Male with elastomer**

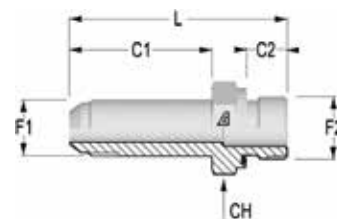

Item Code	Head 1 / Head 2	OD1 in	F1	F2	C1 mm	C2 mm	CH mm	L mm
	Dash							
1212846	-0402	1/4"	7/16-20	1/8-28	35,0	8,0	14,0	50,0
1212847	-0404	1/4"	7/16-20	1/4-19	35,0	12,0	19,0	55,5
1212848	-0406	1/4"	7/16-20	3/8-19	35,0	12,0	22,0	56,8
1212849	-0408	1/4"	7/16-20	1/2-14	35,0	14,0	27,0	60,3
1212850	-0502	5/16"	1/2-20	1/8-28	37,0	8,0	14,0	53,3
1212851	-0504	5/16"	1/2-20	1/4-19	37,0	12,0	19,0	57,5
1212852	-0506	5/16"	1/2-20	3/8-19	37,0	12,0	22,0	57,5
1212853	-0604	3/8"	9/16-18	1/4-19	39,0	12,0	19,0	59,5
1212854	-0606	3/8"	9/16-18	3/8-19	39,0	12,0	22,0	59,5
1212855	-0608	3/8"	9/16-18	1/2-14	39,0	14,0	27,0	63,0
1212856	-0804	1/2"	3/4-16	1/4-19	48,0	12,0	19,0	68,5
1212857	-0806	1/2"	3/4-16	3/8-19	48,0	12,0	22,0	68,5
1212858	-0808	1/2"	3/4-16	1/2-14	48,0	14,0	27,0	72,0
1212859	-0812	1/2"	3/4-16	3/4-14	48,0	17,0	32,0	77,0
1212860	-1006	5/8"	7/8-14	3/8-19	53,0	12,0	24,0	74,0
1212861	-1008	5/8"	7/8-14	1/2-14	53,0	14,0	27,0	77,0
1212862	-1012	5/8"	7/8-14	3/4-14	53,0	17,0	32,0	81,0
1212863	-1208	3/4"	1 1/16-12	1/2-14	63,0	14,0	32,0	88,0
1212864	-1212	3/4"	1 1/16-12	3/4-14	63,0	17,0	32,0	91,0
1212865	-1216	3/4"	1 1/16-12	1-11	63,0	18,0	41,0	93,5
1216388	-1412	7/8"	1 3/16-12	3/4-14	67,0	17,0	32,0	99,3
1212866	-1612	1"	1 5/16-12	3/4-14	72,0	17,0	36,0	100,0
1212867	-1616	1"	1 5/16-12	1-11	72,0	18,0	41,0	102,0
1212868	-1620	1"	1 5/16-12	1 1/4-11	72,0	20,0	50,0	106,0
1212869	-2016	1 1/4"	1 5/8-12	1-11	88,0	18,0	46,0	119,0
1212870	-2020	1 1/4"	1 5/8-12	1 1/4-11	88,0	20,0	50,0	122,0
1212871	-2420	1 1/2"	1 7/8-12	1 1/4-11	98,0	20,0	50,0	132,0
1212872	-2424	1 1/2"	1 7/8-12	1 1/2-11	98,0	22,0	55,0	136,0

Dimensions shown may be changed without prior notice

## // R1A25M406N

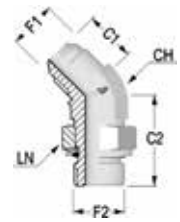
**45° adjustable elbow connector JIC Male - BSPP cylindric Male with O-Ring and retaining ring**

Item Code	Head 1 / Head 2	OD1 in	F1	F2	C1	C2	CH	LN
	Dash				mm	mm	mm	mm
1207325	-0402	1/4"	7/16-20	1/8-28	19,5	26,5	12,0	14,0
1207326	-0404	1/4"	7/16-20	1/4-19	21,0	29,0	14,0	19,0
1212959	-0406	1/4"	7/16-20	3/8-19	22,0	33,0	17,0	22,0
1212960	-0408	1/4"	7/16-20	1/2-14	22,5	38,5	22,0	27,0
1212961	-0502	5/16"	1/2-20	1/8-28	19,5	26,5	14,0	14,0
1211702	-0504	5/16"	1/2-20	1/4-19	19,5	26,5	14,0	19,0
1212962	-0506	5/16"	1/2-20	3/8-19	21,0	32,5	17,0	22,0
1207327	-0604	3/8"	9/16-18	1/4-19	21,0	29,0	14,0	19,0
1207328	-0606	3/8"	9/16-18	3/8-19	22,0	33,0	17,0	22,0
1212963	-0608	3/8"	9/16-18	1/2-14	22,5	38,5	22,0	27,0
1212964	-0804	1/2"	3/4-16	1/4-19	25,0	30,0	19,0	19,0
1207329	-0806	1/2"	3/4-16	3/8-19	25,0	33,0	19,0	22,0
1207330	-0808	1/2"	3/4-16	1/2-14	25,5	38,5	22,0	27,0
1207331	-1008	5/8"	7/8-14	1/2-14	28,0	38,5	22,0	27,0
1208292	-1012	5/8"	7/8-14	3/4-14	30,0	44,0	27,0	36,0
1207333	-1212	3/4"	1 1/16-12	3/4-14	32,5	44,0	27,0	36,0
1212967	-1216	3/4"	1 1/16-12	1-11	37,0	47,0	33,0	41,0
1212968	-1412	7/8"	1 3/16-12	3/4-14	35,0	45,5	33,0	36,0
1212969	-1612	1"	1 5/16-12	3/4-14	37,0	47,0	33,0	36,0
1207334	-1616	1"	1 5/16-12	1-11	37,0	47,0	33,0	41,0
1208380	-2020	1 1/4"	1 5/8-12	1 1/4-11	39,5	48,5	41,0	50,0
1211703	-2424	1 1/2"	1 7/8-12	1 1/2-11	45,0	48,0	48,0	55,0

**// R1A25M906N**

**90° adjustable elbow connector JIC Male - BSPP cylindric Male with O-Ring and retaining ring**

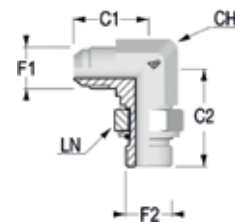

Item Code	Head 1 / Head 2	OD1 in	F1	F2	C1	C2	CH	LN
	Dash				mm	mm	mm	mm
1207238	-0402	1/4"	7/16-20	1/8-28	22,5	26,0	12,0	14,0
1207239	-0404	1/4"	7/16-20	1/4-19	27,0	31,5	14,0	19,0
1213024	-0406	1/4"	7/16-20	3/8-19	28,5	36,5	17,0	22,0
1213025	-0408	1/4"	7/16-20	1/2-14	31,0	43,0	22,0	27,0
1207240	-0502	5/16"	1/2-20	1/8-28	24,0	27,5	14,0	14,0
1207241	-0504	5/16"	1/2-20	1/4-19	27,0	31,5	14,0	19,0
1207743	-0506	5/16"	1/2-20	3/8-19	28,5	36,5	17,0	22,0
1207242	-0604	3/8"	9/16-18	1/4-19	27,0	31,5	14,0	19,0
1207243	-0606	3/8"	9/16-18	3/8-19	28,5	36,5	17,0	22,0
1208226	-0608	3/8"	9/16-18	1/2-14	31,0	43,0	22,0	27,0
1207244	-0804	1/2"	3/4-16	1/4-19	31,5	33,5	19,0	19,0
1207245	-0806	1/2"	3/4-16	3/8-19	31,5	36,5	19,0	22,0
1207246	-0808	1/2"	3/4-16	1/2-14	34,0	43,0	22,0	27,0
1213026	-0812	1/2"	3/4-16	3/4-14	37,0	49,0	27,0	36,0
1207744	-1006	5/8"	7/8-14	3/8-19	36,5	39,5	22,0	22,0
1207247	-1008	5/8"	7/8-14	1/2-14	36,5	43,0	22,0	27,0
1207745	-1012	5/8"	7/8-14	3/4-14	39,5	49,0	27,0	36,0
1207248	-1208	3/4"	1 1/16-12	1/2-14	42,0	45,5	27,0	27,0
1207249	-1212	3/4"	1 1/16-12	3/4-14	42,0	49,0	27,0	36,0
1207250	-1216	3/4"	1 1/16-12	1-11	44,5	52,0	33,0	41,0
1213027	-1412	7/8"	1 3/16-12	3/4-14	44,0	50,5	33,0	36,0
1207251	-1612	1"	1 5/16-12	3/4-14	46,0	52,0	33,0	36,0
1207252	-1616	1"	1 5/16-12	1-11	46,0	52,0	33,0	41,0
1207746	-1620	1"	1 5/16-12	1 1/4-11	51,0	57,0	41,0	50,0
1207253	-2016	1 1/4"	1 5/8-12	1-11	52,0	57,0	41,0	41,0
1207254	-2020	1 1/4"	1 5/8-12	1 1/4-11	52,0	57,0	41,0	50,0
1213028	-2420	1 1/2"	1 7/8-12	1 1/4-11	59,0	61,0	48,0	50,0
1207255	-2424	1 1/2"	1 7/8-12	1 1/2-11	59,0	61,0	48,0	55,0

Dimensions shown may be changed without prior notice

## // R1A25M906Y

90° adjustable long elbow connector JIC Male - BSPP cylindric  
Male with O-Ring and retaining ring

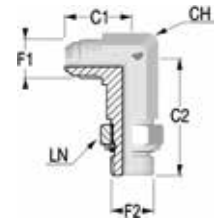

Item Code	Head 1 / Head 2	OD1 in	F1	F2	C1	C2	CH	LN
	Dash				mm	mm	mm	mm
1213029	-0402	1/4"	7/16-20	1/8-28	22,5	46,0	12,0	14,0
1213030	-0404	1/4"	7/16-20	1/4-19	27,0	56,5	14,0	19,0
1213031	-0406	1/4"	7/16-20	3/8-19	28,5	67,0	17,0	22,0
1213032	-0408	1/4"	7/16-20	1/2-14	31,0	78,0	22,0	27,0
1213033	-0502	5/16"	1/2-20	1/8-28	24,0	49,5	14,0	14,0
1213034	-0504	5/16"	1/2-20	1/4-19	27,0	56,5	14,0	19,0
1213035	-0506	5/16"	1/2-20	3/8-19	28,5	67,0	17,0	22,0
1213036	-0604	3/8"	9/16-18	1/4-19	27,0	56,5	14,0	19,0
1213037	-0606	3/8"	9/16-18	3/8-19	28,5	67,0	17,0	22,0
1213038	-0608	3/8"	9/16-18	1/2-14	31,0	78,0	22,0	27,0
1213039	-0804	1/2"	3/4-16	1/4-19	31,5	64,0	19,0	19,0
1213040	-0806	1/2"	3/4-16	3/8-19	31,5	67,0	19,0	22,0
1213041	-0808	1/2"	3/4-16	1/2-14	34,0	78,0	22,0	27,0
1213042	-0812	1/2"	3/4-16	3/4-14	37,0	92,0	27,0	36,0
1213043	-1006	5/8"	7/8-14	3/8-19	36,5	75,0	22,0	22,0
1213044	-1008	5/8"	7/8-14	1/2-14	36,5	78,0	22,0	27,0
1213045	-1012	5/8"	7/8-14	3/4-14	39,5	92,0	27,0	36,0
1213046	-1208	3/4"	1 1/16-12	1/2-14	42,0	88,0	27,0	27,0
1213047	-1216	3/4"	1 1/16-12	1-11	44,5	105,0	33,0	41,0
1216418	-1412	7/8"	1 3/16-12	3/4-14	44,0	99,0	33,0	36,0
1213048	-1616	1"	1 5/16-12	1-11	46,0	105,0	33,0	41,0
1213049	-1620	1"	1 5/16-12	1 1/4-11	51,0	123,0	41,0	50,0
1213050	-2016	1 1/4"	1 5/8-12	1-11	52,0	124,0	41,0	41,0
1213051	-2020	1 1/4"	1 5/8-12	1 1/4-11	52,0	123,0	41,0	50,0
1213052	-2420	1 1/2"	1 7/8-12	1 1/4-11	59,0	134,0	48,0	50,0
1213053	-2424	1 1/2"	1 7/8-12	1 1/2-11	59,0	135,0	48,0	55,0

**// R1A25MT06N**

**Branch Tee adjustable elbow connector JIC Male - BSPP  
cylindric Male with O-Ring and retaining ring**

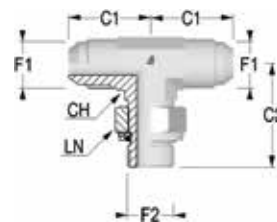

Item Code	Head 1 / Head 2	OD1 in	F1	F2	C1	C2	CH	LN
	Dash				mm	mm	mm	mm
1208134	-0402	1/4"	7/16-20	7/16-20	22,5	22,5	12,0	14,0
1210701	-0404	1/4"	7/16-20	7/16-20	27,0	27,0	14,0	19,0
1212762	-0406	1/4"	7/16-20	7/16-20	28,5	28,5	17,0	22,0
1212763	-0408	1/4"	7/16-20	7/16-20	31,0	31,0	22,0	27,0
1212764	-0502	5/16"	1/2-20	1/2-20	24,0	24,0	14,0	14,0
1207314	-0504	5/16"	1/2-20	1/2-20	27,0	27,0	14,0	19,0
1212765	-0506	5/16"	1/2-20	1/2-20	28,5	28,5	17,0	22,0
1207313	-0604	3/8"	9/16-18	9/16-18	27,0	27,0	14,0	19,0
1210744	-0606	3/8"	9/16-18	9/16-18	28,5	28,5	17,0	22,0
1212766	-0608	3/8"	9/16-18	9/16-18	31,0	31,0	22,0	27,0
1212767	-0804	1/2"	3/4-16	3/4-16	31,5	31,5	19,0	19,0
1240190	-0806	1/2"	3/4-16	3/4-16	31,5	31,5	19,0	22,0
1207316	-0808	1/2"	3/4-16	3/4-16	34,0	34,0	22,0	27,0
1212768	-0812	1/2"	3/4-16	3/4-16	37,0	37,0	27,0	36,0
1212769	-1006	5/8"	7/8-14	7/8-14	36,5	36,5	22,0	22,0
1207317	-1008	5/8"	7/8-14	7/8-14	36,5	36,5	22,0	27,0
1212770	-1012	5/8"	7/8-14	7/8-14	39,5	39,5	27,0	36,0
1207318	-1208	3/4"	1 1/16-12	1 1/16-12	42,0	42,0	27,0	27,0
1207319	-1212	3/4"	1 1/16-12	1 1/16-12	42,0	42,0	27,0	36,0
1212771	-1216	3/4"	1 1/16-12	1 1/16-12	44,5	44,5	33,0	41,0
1216449	-1412	7/8"	1 3/16-12	1 1/16-12	44,0	44,0	33,0	36,0
1212772	-1612	1"	1 5/16-12	1 5/16-12	46,0	46,0	33,0	36,0
1207320	-1616	1"	1 5/16-12	1 5/16-12	46,0	46,0	33,0	41,0
1212773	-1620	1"	1 5/16-12	1 5/16-12	51,0	51,0	41,0	50,0
1212774	-2016	1 1/4"	1 5/8-12	1 5/8-12	52,0	52,0	41,0	41,0
1211631	-2020	1 1/4"	1 5/8-12	1 5/8-12	52,0	52,0	41,0	50,0
1211632	-2420	1 1/2"	1 7/8-12	1 7/8-12	59,0	59,0	48,0	50,0
1211633	-2424	1 1/2"	1 7/8-12	1 7/8-12	59,0	59,0	48,0	55,0

Dimensions shown may be changed without prior notice

## // R1A25ML06N

Run Tee adjustable elbow connector JIC Male - BSPP cylindric  
Male with O-Ring and retaining ring

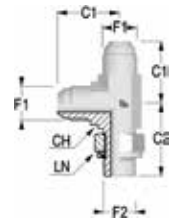

Item Code	Head 1 / Head 2	OD1	F1	F2	C1	C2	CH	LN
	Dash							
1210740	-0402	1/4"	7/16-20	1/8-28	22,5	26,0	12,0	14,0
1210742	-0404	1/4"	7/16-20	1/4-19	27,0	31,5	14,0	19,0
1212702	-0406	1/4"	7/16-20	3/8-19	28,5	36,5	17,0	22,0
1212703	-0408	1/4"	7/16-20	1/2-14	31,0	43,0	22,0	27,0
1210694	-0504	5/16"	1/2-20	1/4-19	27,0	31,5	14,0	19,0
1212704	-0506	5/16"	1/2-20	3/8-19	28,5	36,5	17,0	22,0
1207292	-0604	3/8"	9/16-18	1/4-19	27,0	31,5	14,0	19,0
1207293	-0606	3/8"	9/16-18	3/8-19	28,5	36,5	17,0	22,0
1212705	-0608	3/8"	9/16-18	1/2-14	31,0	43,0	22,0	27,0
1212706	-0804	1/2"	3/4-16	1/4-19	31,5	33,5	19,0	19,0
1207294	-0806	1/2"	3/4-16	3/8-19	31,5	36,5	19,0	22,0
1207295	-0808	1/2"	3/4-16	1/2-14	34,0	43,0	22,0	27,0
1212707	-0812	1/2"	3/4-16	3/4-14	37,0	49,0	27,0	36,0
1212708	-1006	5/8"	7/8-14	3/8-19	36,5	39,5	22,0	22,0
1207748	-1008	5/8"	7/8-14	1/2-14	36,5	43,0	22,0	27,0
1208030	-1012	5/8"	7/8-14	3/4-14	39,5	49,0	27,0	36,0
1207299	-1208	3/4"	1 1/16-12	1/2-14	42,0	45,5	27,0	27,0
1207296	-1212	3/4"	1 1/16-12	3/4-14	42,0	49,0	27,0	36,0
1208124	-1216	3/4"	1 1/16-12	1-11	44,5	52,0	33,0	41,0
1208277	-1612	1"	1 5/16-12	3/4-14	46,0	52,0	33,0	36,0
1207297	-1616	1"	1 5/16-12	1-11	46,0	52,0	33,0	41,0
1212710	-1620	1"	1 5/16-12	1 1/4-11	51,0	57,0	41,0	50,0
1212711	-2016	1 1/4"	1 5/8-12	1-11	52,0	57,0	41,0	41,0
1212712	-2420	1 1/2"	1 7/8-12	1 1/4-11	59,0	61,0	48,0	50,0
1208125	-2424	1 1/2"	1 7/8-12	1 1/2-11	59,0	61,0	48,0	55,0

**// R1A25M107M**

**Straight connector JIC Male - BSPT Male**

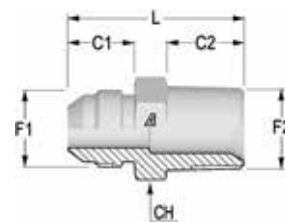

Item Code	Head 1 / Head 2	OD1	F1	F2	C1	C2	CH	L
	Dash	in						
1203683	-0402	1/4"	7/16-20	1/8-28	14,0	8,0	14,0	30,5
1203682	-0404	1/4"	7/16-20	1/4-19	14,0	12,0	14,0	35,5
1203626	-0502	5/16"	1/2-20	1/8-28	14,0	8,0	14,0	30,5
1203625	-0504	5/16"	1/2-20	1/4-19	14,0	12,0	14,0	35,5
1203711	-0604	3/8"	9/16-18	1/4-19	14,0	12,0	17,0	35,5
1203712	-0606	3/8"	9/16-18	3/8-19	14,0	12,0	19,0	35,5
1203710	-0608	3/8"	9/16-18	1/2-14	14,0	14,0	22,0	41,0
1203667	-0804	1/2"	3/4-16	1/4-19	17,0	12,0	19,0	38,5
1203669	-0806	1/2"	3/4-16	3/8-19	17,0	12,0	19,0	38,5
1203666	-0808	1/2"	3/4-16	1/2-14	17,0	14,0	22,0	43,5
1203696	-1006	5/8"	7/8-14	3/8-19	19,5	12,0	24,0	42,0
1203694	-1008	5/8"	7/8-14	1/2-14	19,5	14,0	24,0	46,5
1203695	-1012	5/8"	7/8-14	3/4-14	19,5	16,0	27,0	48,5
1203614	-1208	3/4"	1 1/16-12	1/2-14	22,0	14,0	27,0	51,0
1203615	-1212	3/4"	1 1/16-12	3/4-14	22,0	16,0	27,0	51,0
1203613	-1216	3/4"	1 1/16-12	1-11	22,0	18,0	36,0	56,5
1216391	-1412	7/8"	1 3/16-12	3/4-14	22,5	16,0	32,0	50,5
1203638	-1612	1"	1 5/16-12	3/4-14	23,0	16,0	36,0	53,0
1203636	-1616	1"	1 5/16-12	1-11	23,0	18,0	36,0	58,0
1203644	-2016	1 1/4"	1 5/8-12	1-11	24,5	18,0	46,0	60,5
1203645	-2020	1 1/4"	1 5/8-12	1 1/4-11	24,5	20,0	46,0	61,0
1203652	-2424	1 1/2"	1 7/8-12	1 1/2-11	27,5	20,0	50,0	68,0

Dimensions shown may be changed without prior notice

## // R1A25M907M

## 90° elbow connector JIC Male - BSPT Male

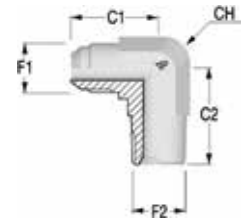

Item Code	Head 1 / Head 2		OD1 in	F1	F2	C1 mm	C2 mm	CH mm
	Dash							
1203874	-0402	1/4"	1/4"	7/16-20	1/8-28	22,5	19,5	12,0
1203873	-0404	1/4"	1/4"	7/16-20	1/4-19	27,0	27,5	14,0
1203840	-0502	5/16"	5/16"	1/2-20	1/8-28	24,0	20,0	14,0
1203839	-0504	5/16"	5/16"	1/2-20	1/4-19	27,0	27,0	14,0
1203895	-0604	3/8"	3/8"	9/16-18	1/4-19	27,0	27,0	14,0
1203896	-0606	3/8"	3/8"	9/16-18	3/8-19	28,5	31,0	17,0
1203894	-0608	3/8"	3/8"	9/16-18	1/2-14	31,0	37,5	22,0
1203864	-0804	1/2"	1/2"	3/4-16	1/4-19	31,5	31,0	19,0
1203865	-0806	1/2"	1/2"	3/4-16	3/8-19	31,5	31,0	19,0
1203863	-0808	1/2"	1/2"	3/4-16	1/2-14	34,0	37,0	22,0
1203883	-1006	5/8"	5/8"	7/8-14	3/8-19	36,5	32,5	22,0
1203881	-1008	5/8"	5/8"	7/8-14	1/2-14	36,5	40,0	22,0
1203882	-1012	5/8"	5/8"	7/8-14	3/4-14	39,5	40,5	27,0
1203835	-1212	3/4"	3/4"	1 1/16-12	3/4-14	42,0	40,5	27,0
1203833	-1216	3/4"	3/4"	1 1/16-12	1-11	44,5	50,0	33,0
1216419	-1412	7/8"	7/8"	1 3/16-12	3/4-14	44,0	43,0	33,0
1203847	-1612	1"	1"	1 5/16-12	3/4-14	46,0	45,0	33,0
1203846	-1616	1"	1"	1 5/16-12	1-11	46,0	50,0	33,0
1205460	-2016	1"1/4	1"1/4	1 5/8-12	1-11	52,0	59,5	41,0
1203853	-2020	1"1/4	1"1/4	1 5/8-12	1 1/4-11	52,0	60,5	41,0
1213054	-2424	1"1/2	1"1/2	1 7/8-12	1 1/2-11	59,0	67,0	48,0



// METRIC

// R1A2511525

Straight connector JIC Female - Metric Male with O-Ring

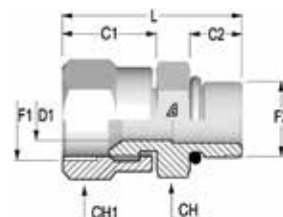

Item Code	Head 1 / Head 2	OD1 in	F1	F2	C1	C2	CH	CH1	L mm
	Dash/mm				mm	mm	mm	mm	
1207442	-0410	1/4"	7/16-20	M10X1.0	17,0	8,5	14,0	16,0	34,5
1216347	-0412	1/4"	7/16-20	M12X1.5	17,0	11,0	17,0	16,0	36,5
1216348	-0510	5/16"	1/2-20	M10X1.0	18,5	8,5	14,0	17,0	36,5
1207443	-0512	5/16"	1/2-20	M12X1.5	18,5	11,0	17,0	17,0	39,0
1216349	-0514	5/16"	1/2-20	M14X1.5	18,5	11,0	19,0	17,0	40,0
1207444	-0614	3/8"	9/16-18	M14X1.5	19,0	11,0	19,0	19,0	41,0
1216350	-0616	3/8"	9/16-18	M16X1.5	19,0	11,5	22,0	19,0	42,5
1216351	-0818	1/2"	3/4-16	M18X1.5	22,5	12,5	24,0	25,0	45,5
1207629	-1018	5/8"	7/8-14	M18X1.5	25,5	12,5	24,0	27,0	48,5
1216352	-1020	5/8"	7/8-14	-	25,5	13,0	24,0	27,0	50,0
1207446	-1022	5/8"	7/8-14	M22X1.5	25,5	13,0	27,0	27,0	51,0
1216353	-1222	3/4"	1 1/16-12	M22X1.5	27,0	13,0	27,0	32,0	53,5
1207447	-1227	3/4"	1 1/16-12	M27X2	27,0	16,0	32,0	32,0	57,5
1216354	-1426	7/8"	1 3/16-12	M26X1.5	49,5	16,0	32,0	36,0	60,0
1216355	-1627	1"	1 5/16-12	M27X2	30,0	16,0	36,0	38,0	60,0
1207448	-1633	1"	1 5/16-12	M33X2.0	30,0	16,0	41,0	38,0	61,0

Dimensions shown may be changed without prior notice

## // R1A25M1525

## Straight connector JIC Male - Metric Male with O-Ring

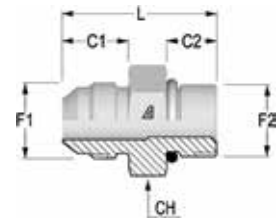

Item Code	Head 1 / Head 2	OD1	F1	F2	C1	C2	CH	L
	Dash	in						
1207635	-0412	1/4"	7/16-20	M12X1.5	14,0	13,5	17,0	31,5
1207636	-0510	5/16"	1/2-20	M10X1.0	14,0	11,0	14,0	30,5
1224083	-0512	5/16"	1/2-20	M12X1.5	14,0	13,5	17,0	33,5
1207408	-0614	3/8"	9/16-18	M14X1.5	14,0	13,5	19,0	33,5
1207639	-0616	3/8"	9/16-18	M16X1.5	14,0	14,0	22,0	35,0
1211696	-0816	1/2"	3/4-16	M16X1.5	16,5	14,0	22,0	35,0
1207387	-0818	1/2"	3/4-16	M18X1.5	16,5	15,0	24,0	37,0
1225818	-1018	5/8"	7/8-14	M18X1.5	19,5	15,0	24,0	38,5
1212958	-1020	5/8"	7/8-14	M20X1.5	19,5	15,5	24,0	41,5
1207405	-1022	5/8"	7/8-14	M22X1.5	22,0	15,5	27,0	43,0
1207404	-1222	3/4"	1 1/16-12	M22X1.5	22,0	18,5	27,0	45,5
1207403	-1227	3/4"	1 1/16-12	M27X2	23,0	18,5	32,0	49,0
1216402	-1627	1"	1 5/16-12	M27X2	24,5	18,5	36,0	50,5
1207402	-1633	1"	1 5/16-12	M33X2.0	27,5	20,0	41,0	51,0
1207401	-2042	1"1/4	1 5/8-12	M42X2	66,0	16,0	50,0	55,0
1207400	-2448	1"1/2	1 7/8-12	M48X2.0	76,0	17,5	55,0	60,0

**// R1A25M152I**

**Straight connector JIC Male - Metric Male with elastomer**

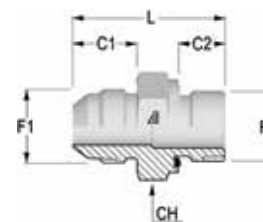

Item Code	Head 1 / Head 2	OD1	F1	F2	C1	C2	CH	L
	Dash							
1207390	-0410	1/4"	7/16-20	M10X1.0	14,0	8,0	14,0	31,0
1212950	-0412	1/4"	7/16-20	M12X1.5	14,0	12,0	17,0	33,5
1212951	-0510	5/16"	1/2-20	M10X1.0	14,0	8,0	14,0	30,5
1207391	-0512	5/16"	1/2-20	M12X1.5	14,0	12,0	17,0	33,5
1208306	-0514	5/16"	1/2-20	M14X1.5	14,0	12,0	19,0	35,0
1207392	-0614	3/8"	9/16-18	M14X1.5	14,0	12,0	19,0	33,5
1212952	-0616	3/8"	9/16-18	M16X1.5	14,0	12,0	22,0	35,5
1207393	-0816	1/2"	3/4-16	M16X1.5	16,5	12,0	22,0	37,5
1207388	-0818	1/2"	3/4-16	M18X1.5	16,5	12,0	24,0	39,0
1207389	-1018	5/8"	7/8-14	M18X1.5	19,5	12,0	24,0	41,5
1212953	-1020	5/8"	7/8-14	M20X1.5	19,5	14,0	24,0	43,5
1207394	-1022	5/8"	7/8-14	M22X1.5	19,5	14,0	27,0	43,0
1207395	-1222	3/4"	1 1/16-12	M22X1.5	22,0	14,0	27,0	45,5
1207396	-1227	3/4"	1 1/16-12	M27X2	22,0	16,0	32,0	49,0
1216405	-1426	7/8"	1 3/16-12	M26X1.5	22,5	16,0	32,0	49,5
1212957	-1627	1"	1 5/16-12	M27X2	23,0	16,0	36,0	55,0
1207397	-1633	1"	1 5/16-12	M33X2.0	23,0	18,0	41,0	51,5
1207398	-2042	1 1/4"	1 5/8-12	M42X2	24,5	20,0	50,0	55,0
1207399	-2448	1 1/2"	1 7/8-12	M48X2.0	27,5	22,0	55,0	60,5

**// R1A25M152H**

**Long connector JIC Male - Metric Male with elastomer**

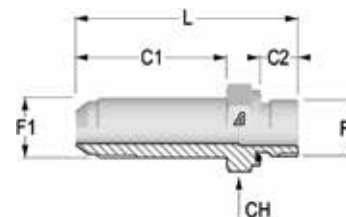

Item Code	Head 1 / Head 2	OD1	F1	F2	C1	C2	CH	L
	Dash							
1212934	-0410	1/4"	7/16-20	M10X1.0	35,0	9,5	14,0	51,0
1212935	-0510	5/16"	1/2-20	M10X1.0	37,0	9,5	14,0	53,0
1212936	-0512	5/16"	1/2-20	M12X1.5	37,0	14,0	17,0	55,5
1212937	-0514	5/16"	1/2-20	M14X1.5	37,0	14,0	19,0	56,5
1212938	-0614	3/8"	9/16-18	M14X1.5	39,0	14,0	19,0	58,5
1212939	-0616	3/8"	9/16-18	M16X1.5	39,0	14,0	22,0	60,0
1212940	-0816	1/2"	3/4-16	M16X1.5	48,0	14,0	22,0	69,0
1212941	-0818	1/2"	3/4-16	M18X1.5	48,0	14,5	24,0	70,5
1212942	-1018	5/8"	7/8-14	M18X1.5	53,0	14,5	24,0	75,5
1212943	-1022	5/8"	7/8-14	M22X1.5	53,0	17,0	27,0	78,0
1212944	-1222	3/4"	1 1/16-12	M22X1.5	63,0	17,0	27,0	89,0
1212945	-1227	3/4"	1 1/16-12	M27X2	63,0	19,0	32,0	92,5
1212946	-1627	1"	1 5/16-12	M27X2	72,0	19,0	36,0	102,0
1212947	-1633	1"	1 5/16-12	M33X2.0	72,0	21,0	41,0	102,5
1212948	-2042	1 1/4"	1 5/8-12	M42X2	88,0	23,0	50,0	121,0
1212949	-2448	1 1/2"	1 7/8-12	M48X2.0	88,0	25,0	55,0	136,0

Dimensions shown may be changed without prior notice

## // R1A25M952Q

90° adjustable elbow connector JIC Male - Metric Male with O-Ring and retaining ring

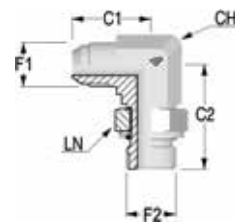

Item Code	Head 1 / Head 2	OD1 in	F1	F2	C1	C2	CH	LN
	Dash				mm	mm	mm	mm
1207275	-0410	1/4"	7/16-20	M10X1.0	22,5	27,5	12,0	14,0
1213138	-0412	1/4"	7/16-20	M12X1.5	27,0	31,5	14,0	17,0
1213140	-0510	5/16"	1/2-20	M10X1.0	24,0	27,5	14,0	14,0
1207276	-0512	5/16"	1/2-20	M12X1.5	27,0	31,5	14,0	17,0
1213141	-0514	5/16"	1/2-20	M14X1.5	27,0	32,5	14,0	19,0
1207277	-0614	3/8"	9/16-18	M14X1.5	27,0	32,5	14,0	19,0
1213142	-0616	3/8"	9/16-18	M16X1.5	28,5	36,5	17,0	22,0
1207278	-0816	1/2"	3/4-16	M16X1.5	31,5	36,5	19,0	22,0
1207523	-0818	1/2"	3/4-16	M18X1.5	31,5	39,5	19,0	24,0
1207279	-1018	5/8"	7/8-14	M18X1.5	36,5	41,5	22,0	24,0
1213144	-1020	5/8"	7/8-14	M20X1.5	36,5	43,0	22,0	27,0
1207280	-1022	5/8"	7/8-14	M22X1.5	36,5	43,0	22,0	27,0
1207281	-1222	3/4"	1 1/16-12	M22X1.5	42,0	45,5	27,0	27,0
1210693	-1227	3/4"	1 1/16-12	M27X2	42,0	51,5	27,0	32,0
1213145	-1426	7/8"	1 3/16-12	M26X1.5	44,0	50,5	27,0	36,0
1213146	-1627	1"	1 5/16-12	M27X2	46,0	55,0	33,0	32,0
1207282	-1633	1"	1 5/16-12	M33X1.5	46,0	55,0	33,0	41,0
1211742	-2042	1"1/4	1 5/8-12	M42X2	52,0	60,0	41,0	50,0
1213147	-2448	1"1/2	1 7/8-12	M48X1.5	59,0	67,0	48,0	55,0

**// R1A25M952Y**

**90° adjustable long elbow connector JIC Male - Metric Male with O-Ring and retaining ring**

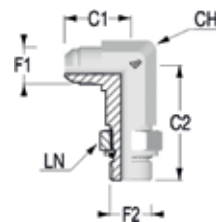

Item Code	Head 1 / Head 2	OD1 in	F1	F2	C1	C2	CH	LN
	Dash				mm	mm	mm	mm
1213148	-0410	1/4"	7/16-20	M10X1.0	22,5	46,0	12,0	14,0
1213149	-0412	1/4"	7/16-20	M12X1.5	27,0	53,5	14,0	17,0
1213150	-0510	5/16"	1/2-20	M10X1.0	24,0	49,5	14,0	14,0
1213151	-0512	5/16"	1/2-20	M12X1.5	27,0	53,5	14,0	17,0
1213152	-0514	5/16"	1/2-20	M14X1.5	27,0	56,5	14,0	19,0
1213153	-0614	3/8"	9/16-18	M14X1.5	27,0	56,5	14,0	19,0
1213154	-0616	3/8"	9/16-18	M16X1.5	28,5	67,0	17,0	22,0
1213155	-0816	1/2"	3/4-16	M16X1.5	31,5	67,0	19,0	22,0
1213156	-0818	1/2"	3/4-16	M18X1.5	31,5	67,0	19,0	24,0
1213157	-1018	5/8"	7/8-14	M18X1.5	36,5	75,0	22,0	24,0
1213158	-1020	5/8"	7/8-14	M20X1.5	36,5	78,0	22,0	27,0
1213159	-1022	5/8"	7/8-14	M22X1.5	36,5	78,0	22,0	27,0
1213160	-1222	3/4"	1 1/16-12	M22X1.5	42,0	88,0	27,0	27,0
1213161	-1227	3/4"	1 1/16-12	M27X2	42,0	95,0	27,0	32,0
1216432	-1426	7/8"	1 3/16-12	M26X1.5	44,0	97,0	27,0	36,0
1213162	-1627	1"	1 5/16-12	M27X2	46,0	105,0	33,0	32,0
1213163	-1633	1"	1 5/16-12	M33X1.5	46,0	105,0	33,0	41,0
1213164	-2042	1 1/4"	1 5/8-12	M42X2	52,0	124,0	41,0	50,0
1213165	-2448	1 1/2"	1 7/8-12	M48X1.5	59,0	141,0	48,0	55,0

Dimensions shown may be changed without prior notice

## // R1A25MT52Q

Branch Tee adjustable elbow connector JIC Male - Metric Male  
with O-Ring and retaining ring

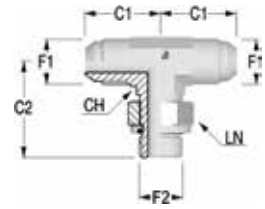

Item Code	Head 1 / Head 2	OD1	F1	F2	C1	C2	CH	LN
	Dash	in						
1211640	-0410	1/4"	7/16-20	7/16-20	22,5	22,5	12,0	14,0
1212815	-0412	1/4"	7/16-20	7/16-20	27,0	27,0	14,0	17,0
1212816	-0510	5/16"	1/2-20	1/2-20	24,0	24,0	14,0	14,0
1210706	-0512	5/16"	1/2-20	1/2-20	27,0	27,0	14,0	17,0
1212817	-0514	5/16"	1/2-20	1/2-20	27,0	27,0	14,0	19,0
1207324	-0614	3/8"	9/16-18	9/16-18	27,0	27,0	14,0	19,0
1212818	-0616	3/8"	9/16-18	9/16-18	28,5	28,5	17,0	22,0
1210707	-0816	1/2"	3/4-16	3/4-16	31,5	31,5	19,0	22,0
1212819	-0818	1/2"	3/4-16	3/4-16	31,5	31,5	19,0	24,0
1212820	-1020	5/8"	7/8-14	7/8-14	36,5	36,5	22,0	27,0
1211641	-1022	5/8"	7/8-14	7/8-14	36,5	36,5	22,0	27,0
1212821	-1222	3/4"	1 1/16-12	1 1/16-12	42,0	42,0	27,0	27,0
1211642	-1227	3/4"	1 1/16-12	1 1/16-12	42,0	42,0	27,0	32,0
1216493	-1426	7/8"	1 3/16-12	1 3/16-12	44,0	44,0	27,0	36,0
1212822	-1627	1"	1 5/16-12	1 5/16-12	46,0	46,0	33,0	32,0
1211643	-1633	1"	1 5/16-12	1 5/16-12	46,0	46,0	33,0	41,0
1211644	-2042	1"1/4	1 5/8-12	1 5/8-12	52,0	52,0	41,0	50,0
1211645	-2448	1"1/2	1 7/8-12	1 7/8-12	59,0	59,0	48,0	55,0

## // R1A25ML52Q

Run Tee adjustable elbow connector JIC Male - Metric Male with  
O-Ring and retaining ring

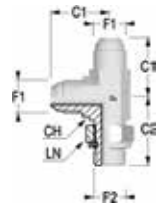

Item Code	Head 1 / Head 2	OD1	F1	F2	C1	C2	CH	LN
	Dash	in						
1210699	-0410	1/4"	7/16-20	M10X1.0	22,5	27,5	12,0	14,0
1212753	-0412	1/4"	7/16-20	M12X1.5	27,0	31,5	14,0	17,0
1212754	-0510	5/16"	1/2-20	M10X1.0	24,0	27,5	14,0	14,0
1211626	-0512	5/16"	1/2-20	M12X1.5	27,0	31,5	14,0	17,0
1212755	-0514	5/16"	1/2-20	M14X1.5	27,0	32,5	14,0	19,0
1207303	-0614	3/8"	9/16-18	M14X1.5	27,0	32,5	14,0	19,0
1212756	-0616	3/8"	9/16-18	M16X1.5	28,5	36,5	17,0	22,0
1207302	-0816	1/2"	3/4-16	M16X1.5	31,5	36,5	19,0	22,0
1212757	-0818	1/2"	3/4-16	M18X1.5	31,5	39,5	19,0	24,0
1212758	-1018	5/8"	7/8-14	M18X1.5	36,5	41,5	22,0	24,0
1212759	-1020	5/8"	7/8-14	M20X1.5	36,5	43,0	22,0	27,0
1210700	-1022	5/8"	7/8-14	M22X1.5	36,5	43,0	22,0	27,0
1212760	-1222	3/4"	1 1/16-12	M22X1.5	42,0	45,5	27,0	27,0
1211627	-1227	3/4"	1 1/16-12	M27X2	42,0	51,5	27,0	32,0
1216448	-1426	7/8"	1 3/16-12	M26X1.5	44,0	50,5	27,0	36,0
1212761	-1627	1"	1 5/16-12	M27X2	46,0	55,0	33,0	32,0
1211628	-1633	1"	1 5/16-12	M33X1.5	46,0	55,0	33,0	41,0
1211629	-2042	1"1/4	1 5/8-12	M42X2	52,0	60,0	41,0	50,0
1211630	-2448	1"1/2	1 7/8-12	M48X1.5	59,0	67,0	48,0	55,0

# // SAE UNF

## // R1A25M1305

**Straight connector JIC Male - SAE UNF/UN Male with O-Ring**

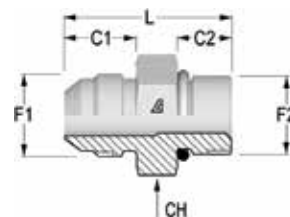

Item Code	Head 1 / Head 2	OD1	F1	F2	C1	C2	CH	L
	Dash							
1207370	-0404	1/4"	7/16-20	7/16-20	8,3	9,0	14,0	31,0
1207371	-0405	1/4"	7/16-20	1/2-20	8,3	9,0	16,0	31,0
1207630	-0406	1/4"	7/16-20	9/16-18	8,3	10,0	17,0	32,5
1207372	-0505	5/16"	1/2-20	1/2-20	9,0	9,0	17,0	31,0
1208278	-0604	3/8"	9/16-18	7/16-20	9,0	9,0	17,0	32,0
1216397	-0605	3/8"	9/16-18	1/2-20	9,0	9,0	17,0	32,5
1207373	-0606	3/8"	9/16-18	9/16-18	9,0	10,0	17,0	33,0
1207374	-0608	3/8"	9/16-18	3/4-16	9,0	11,0	22,0	35,0
1207375	-0808	1/2"	3/4-16	3/4-16	11,5	11,0	22,0	38,0
1207376	-0810	1/2"	3/4-16	7/8-14	11,5	12,5	27,0	40,5
1207631	-0812	1/2"	3/4-16	1 1/16-12	11,5	15,0	32,0	44,5
1207632	-1008	5/8"	7/8-14	3/4-16	12,5	11,0	27,0	41,5
1207377	-1010	5/8"	7/8-14	7/8-14	12,5	12,5	27,0	43,0
1207633	-1012	5/8"	7/8-14	1 1/16-12	12,5	15,0	32,0	47,0
1207378	-1208	3/4"	1 1/16-12	3/4-16	13,0	11,0	27,0	48,5
1207379	-1210	3/4"	1 1/16-12	7/8-14	13,0	12,5	27,0	47,5
1207380	-1212	3/4"	1 1/16-12	1 1/16-12	13,0	15,0	32,0	50,0
1207381	-1216	3/4"	1 1/16-12	1 5/16-12	13,0	15,0	38,0	50,5
1216398	-1414	7/8"	1 3/16-12	1 3/16-12	12,4	15,0	36,0	50,5
1207382	-1612	1"	1 5/16-12	1 1/16-12	14,5	15,0	36,0	50,5
1207383	-1616	1"	1 5/16-12	1 5/16-12	14,5	15,0	38,0	52,0
1207634	-1620	1"	1 5/16-12	1 5/8-12	14,5	15,0	46,0	54,0
1205938	-2016	1"1/4	1 5/8-12	1 5/16-12	16,1	15,0	46,0	55,5
1207384	-2020	1"1/4	1 5/8-12	1 5/8-12	16,1	15,0	46,0	55,0
1207385	-2424	1"1/2	1 7/8-12	1 7/8-12	18,4	15,0	55,0	60,5

Dimensions shown may be changed without prior notice

## // R1A25M130J

## Long connector JIC Male - SAE UNF/UN Male with O-Ring

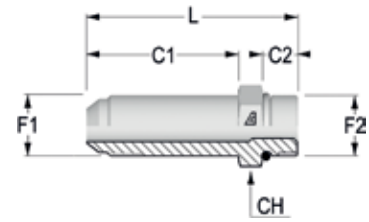

Item Code	Head 1 / Head 2	OD1 in	F1	F2	C1	C2	CH mm	L mm
	Dash				mm	mm		
1212883	-0404	1/4"	7/16-20	7/16-20	35,0	9,0	14,0	52,5
1212884	-0405	1/4"	7/16-20	1/2-20	35,0	9,0	14,0	52,5
1212885	-0406	1/4"	7/16-20	9/16-18	35,0	10,0	16,0	54,5
1212886	-0505	5/16"	1/2-20	1/2-20	37,0	9,0	17,0	54,5
1212888	-0606	3/8"	9/16-18	9/16-18	39,0	10,0	17,0	58,5
1212889	-0608	3/8"	9/16-18	3/4-16	39,0	11,0	22,0	60,0
1212890	-0808	1/2"	3/4-16	3/4-16	48,0	11,0	22,0	68,5
1212891	-0810	1/2"	3/4-16	7/8-14	48,0	12,5	27,0	71,5
1212892	-0812	1/2"	3/4-16	1 1/16-12	48,0	15,0	32,0	76,0
1212893	-1008	5/8"	7/8-14	3/4-16	53,0	11,0	22,0	75,5
1212894	-1010	5/8"	7/8-14	7/8-14	53,0	12,5	27,0	77,0
1212895	-1012	5/8"	7/8-14	1 1/16-12	53,0	15,0	27,0	81,5
1212898	-1212	3/4"	1 1/16-12	1 1/16-12	63,0	15,0	32,0	91,5
1212899	-1216	3/4"	1 1/16-12	1 5/16-12	63,0	15,0	41,0	92,5
1216400	-1414	7/8"	1 3/16-12	1 3/16-12	68,0	15,0	32,0	96,5
1212900	-1612	1"	1 5/16-12	1 1/16-12	72,0	15,0	32,0	100,0
1212901	-1616	1"	1 5/16-12	1 5/16-12	72,0	15,0	41,0	101,0
1212903	-2020	1"1/4	1 5/8-12	1 5/8-12	88,0	15,0	46,0	119,0
1212904	-2424	1"1/2	1 7/8-12	1 7/8-12	98,0	15,0	50,0	131,0



**// R1A2511305**

**Straight connector JIC Female - SAE UNF/UN Male with O-Ring**

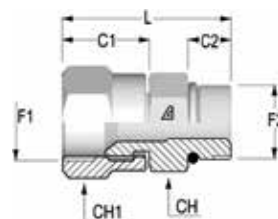

Item Code	Head 1 / Head 2	OD1 in	F1	F2	C1	C2	CH	CH1	L
	Dash/mm				mm	mm	mm	mm	
1207435	-0404	1/4"	7/16-20	7/16-20	8,3	9,0	14,0	16,0	34,0
1213175	-0405	1/4"	7/16-20	1/2-20	8,3	9,0	14,0	16,0	34,0
1213176	-0406	1/4"	7/16-20	9/16-18	8,3	10,0	16,0	16,0	35,0
1207436	-0505	5/16"	1/2-20	1/2-20	9,0	9,0	17,0	17,0	35,5
1207437	-0606	3/8"	9/16-18	9/16-18	9,0	10,0	17,0	19,0	37,0
1213177	-0608	3/8"	9/16-18	3/4-16	9,0	11,0	22,0	19,0	40,0
1207438	-0808	1/2"	3/4-16	3/4-16	11,5	11,0	22,0	25,0	43,5
1213178	-0810	1/2"	3/4-16	7/8-14	11,5	12,5	27,0	25,0	46,5
1213179	-0812	1/2"	3/4-16	1 1/16-12	11,5	15,0	32,0	25,0	49,5
1213180	-1008	5/8"	7/8-14	3/4-16	12,5	11,0	22,0	27,0	46,5
1207439	-1010	5/8"	7/8-14	7/8-14	12,5	12,5	27,0	27,0	49,5
1213181	-1012	5/8"	7/8-14	1 1/16-12	12,5	15,0	27,0	27,0	52,5
1213183	-1210	3/4"	1 1/16-12	7/8-14	13,0	12,5	27,0	32,0	51,0
1207440	-1212	3/4"	1 1/16-12	1 1/16-12	13,0	15,0	32,0	32,0	54,0
1213184	-1216	3/4"	1 1/16-12	1 5/16-12	13,0	15,0	41,0	32,0	54,0
1216346	-1414	7/8"	1 3/16-12	1 3/16-12	12,4	15,0	32,0	36,0	54,1
1213185	-1612	1"	1 5/16-12	1 1/16-12	14,5	15,0	32,0	38,0	57,0
1207441	-1616	1"	1 5/16-12	1 5/16-12	14,5	15,0	41,0	38,0	57,0
1213208	-2424	1 1/2"	1 7/8-12	1 7/8-12	18,4	15,0	50,0	55,0	67,0

Dimensions shown may be changed without prior notice

## // R1A25M4305

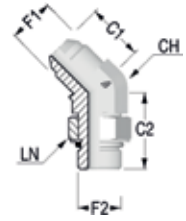
**45° adjustable elbow connector JIC Male - SAE UNF/UN Male with O-Ring**

Item Code	Head 1 / Head 2	OD1 in	F1	F2	C1	C2	CH	LN
	Dash				mm	mm	mm	mm
1212979	-0405	1/4"	7/16-20	1/2-20	21,0	26,5	14,0	17,0
1207335	-0505	5/16"	1/2-20	1/2-20	21,0	26,5	14,0	17,0
1207336	-0606	3/8"	9/16-18	9/16-18	19,5	26,5	14,0	19,0
1212980	-0608	3/8"	9/16-18	3/4-16	22,5	38,0	19,0	24,0
1207337	-0808	1/2"	3/4-16	3/4-16	25,0	33,0	19,0	24,0
1212981	-0810	1/2"	3/4-16	7/8-14	27,5	42,5	22,0	27,0
1212982	-1008	5/8"	7/8-14	3/4-16	28,0	37,0	22,0	24,0
1207338	-1010	5/8"	7/8-14	7/8-14	28,0	38,5	22,0	27,0
1216413	-1012	5/8"	7/8-14	1 1/16-12	28,5	44,0	27,0	32,0
1212983	-1208	3/4"	1 1/16-12	3/4-16	32,5	37,5	27,0	24,0
1211710	-1210	3/4"	1 1/16-12	7/8-14	32,5	40,5	27,0	27,0
1207339	-1212	3/4"	1 1/16-12	1 1/16-12	32,5	44,0	27,0	32,0
1212984	-1216	3/4"	1 1/16-12	1 5/16-12	32,5	47,0	33,0	41,0
1212985	-1414	7/8"	1 3/16-12	1 3/16-12	37,0	47,0	33,0	38,0
1212986	-1612	1"	1 5/16-12	1 1/16-12	37,5	44,0	33,0	32,0
1207340	-1616	1"	1 5/16-12	1 5/16-12	37,5	47,0	33,0	41,0
1212987	-1620	1"	1 5/16-12	1 5/8-12	40,0	48,5	41,0	50,0
1211711	-2020	1"1/4	1 5/8-12	1 5/8-12	40,5	48,5	41,0	50,0
1211712	-2424	1"1/2	1 7/8-12	1 7/8-12	45,0	48,5	48,0	55,0

**// R1A25M9305**

**90° adjustable elbow connector JIC Male - SAE UNF/UN Male with O-Ring**

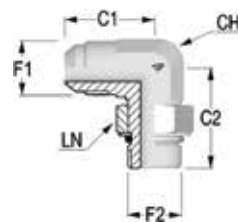

Item Code	Head 1 / Head 2	OD1	F1	F2	C1	C2	CH	LN
	Dash							
1207256	-0404	1/4"	7/16-20	7/16-20	22,5	26,0	12,0	16,0
1207640	-0405	1/4"	7/16-20	1/2-20	24,0	27,5	14,0	17,0
1213077	-0406	1/4"	7/16-20	9/16-18	27,0	31,5	14,0	19,0
1207257	-0505	5/16"	1/2-20	1/2-20	24,0	27,5	14,0	17,0
1207258	-0606	3/8"	9/16-18	9/16-18	27,0	31,5	14,0	19,0
1207641	-0608	3/8"	9/16-18	3/4-16	28,5	36,5	19,0	24,0
1216429	-0610	3/8"	9/16-18	7/8-14	31,0	43,5	22,0	27,0
1207259	-0808	1/2"	3/4-16	3/4-16	31,5	36,5	19,0	24,0
1207642	-0810	1/2"	3/4-16	7/8-14	34,0	43,0	22,0	27,0
1213079	-0812	1/2"	3/4-16	1 1/16-12	37,0	49,0	27,0	32,0
1207643	-1008	5/8"	7/8-14	3/4-16	36,5	39,5	22,0	24,0
1207260	-1010	5/8"	7/8-14	7/8-14	36,5	43,0	22,0	27,0
1213080	-1012	5/8"	7/8-14	1 1/16-12	39,5	49,0	27,0	32,0
1213081	-1208	3/4"	1 1/16-12	3/4-16	42,0	42,0	27,0	24,0
1207261	-1210	3/4"	1 1/16-12	7/8-14	42,0	45,5	27,0	27,0
1207262	-1212	3/4"	1 1/16-12	1 1/16-12	42,0	49,0	27,0	32,0
1213082	-1216	3/4"	1 1/16-12	1 5/16-12	44,5	52,0	33,0	41,0
1213083	-1414	7/8"	1 3/16-12	1 3/16-12	44,0	50,5	33,0	38,0
1207263	-1612	1"	1 5/16-12	1 1/16-12	46,0	52,0	33,0	32,0
1207264	-1616	1"	1 5/16-12	1 5/16-12	46,0	54,6	33,0	41,0
1213084	-1620	1"	1 5/16-12	1 5/8-12	51,0	57,0	41,0	50,0
1207265	-2020	1 1/4"	1 5/8-12	1 5/8-12	52,0	57,0	41,0	50,0
1211738	-2424	1 1/2"	1 7/8-12	1 7/8-12	59,0	61,0	48,0	55,0

Dimensions shown may be changed without prior notice

## // R1A25M930J

90° adjustable long elbow connector JIC Male - SAE UNF/UN  
Male with O-Ring

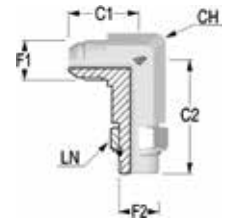

Item Code	Head 1 / Head 2	OD1 in	F1	F2	C1	C2	CH	LN
	Dash				mm	mm	mm	mm
1213056	-0404	1/4"	7/16-20	7/16-20	22,5	46,0	12,0	16,0
1213057	-0405	1/4"	7/16-20	1/2-20	24,0	49,5	14,0	17,0
1213058	-0406	1/4"	7/16-20	9/16-18	27,0	56,5	14,0	19,0
1213059	-0505	5/16"	1/2-20	1/2-20	24,0	49,5	14,0	17,0
1213060	-0606	3/8"	9/16-18	9/16-18	27,0	56,5	14,0	19,0
1213061	-0608	3/8"	9/16-18	3/4-16	28,5	67,0	19,0	24,0
1213062	-0808	1/2"	3/4-16	3/4-16	31,5	67,0	19,0	24,0
1213063	-0810	1/2"	3/4-16	7/8-14	34,0	78,0	22,0	27,0
1213064	-0812	1/2"	3/4-16	1 1/16-12	37,0	92,0	27,0	32,0
1213065	-1008	5/8"	7/8-14	3/4-16	36,5	75,0	22,0	24,0
1213066	-1010	5/8"	7/8-14	7/8-14	36,5	78,0	22,0	27,0
1213067	-1012	5/8"	7/8-14	1 1/16-12	39,5	92,0	27,0	32,0
1213068	-1208	3/4"	1 1/16-12	3/4-16	42,0	85,0	27,0	24,0
1213069	-1210	3/4"	1 1/16-12	7/8-14	42,0	88,0	27,0	27,0
1213070	-1212	3/4"	1 1/16-12	1 1/16-12	42,0	92,0	27,0	32,0
1213071	-1216	3/4"	1 1/16-12	1 5/16-12	44,5	105,0	33,0	41,0
1216431	-1414	7/8"	1 3/16-12	1 3/16-12	44,0	92,0	33,0	38,0
1213072	-1612	1"	1 5/16-12	1 1/16-12	46,0	105,0	33,0	32,0
1213073	-1616	1"	1 5/16-12	1 5/16-12	46,0	105,0	33,0	41,0
1213074	-1620	1"	1 5/16-12	1 5/8-12	51,0	124,0	41,0	50,0
1213075	-2020	1 1/4"	1 5/8-12	1 5/8-12	52,0	124,0	41,0	50,0
1213076	-2424	1 1/2"	1 7/8-12	1 7/8-12	59,0	135,0	48,0	55,0

**// R1A25MT305**

**Branch Tee adjustable elbow connector JIC Male - SAE UNF/UN  
Male with O-Ring**

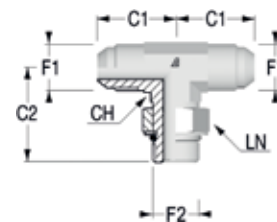

Item Code	Head 1 / Head 2	OD1 in	F1	F2	C1	C2	CH mm	LN mm
	Dash				mm	mm		
1210702	-0404	1/4"	7/16-20	7/16-20	22,5	22,5	12,0	16,0
1212777	-0405	1/4"	7/16-20	7/16-20	24,0	24,0	14,0	17,0
1212778	-0406	1/4"	7/16-20	7/16-20	27,0	27,0	14,0	19,0
1210703	-0505	5/16"	1/2-20	1/2-20	24,0	24,0	14,0	17,0
1207321	-0606	3/8"	9/16-18	9/16-18	27,0	27,0	14,0	19,0
1212779	-0608	3/8"	9/16-18	9/16-18	28,5	28,5	19,0	24,0
1207322	-0808	1/2"	3/4-16	3/4-16	31,5	31,5	19,0	24,0
1212780	-0810	1/2"	3/4-16	3/4-16	34,0	34,0	22,0	27,0
1212781	-0812	1/2"	3/4-16	3/4-16	37,0	37,0	27,0	32,0
1212782	-1008	5/8"	7/8-14	7/8-14	36,5	36,5	22,0	24,0
1207323	-1010	5/8"	7/8-14	7/8-14	36,5	36,5	22,0	27,0
1212783	-1012	5/8"	7/8-14	7/8-14	39,5	39,5	27,0	32,0
1212784	-1208	3/4"	1 1/16-12	1 1/16-12	42,0	42,0	27,0	24,0
1212785	-1210	3/4"	1 1/16-12	1 1/16-12	42,0	42,0	27,0	27,0
1210704	-1212	3/4"	1 1/16-12	1 1/16-12	42,0	42,0	27,0	32,0
1212786	-1216	3/4"	1 1/16-12	1 1/16-12	44,5	44,5	33,0	41,0
1216491	-1414	7/8"	1 3/16-12	1 3/16-12	44,0	44,0	33,0	38,0
1212787	-1612	1"	1 5/16-12	1 5/16-12	46,0	46,0	33,0	32,0
1210705	-1616	1"	1 5/16-12	1 5/16-12	46,0	46,0	33,0	41,0
1212788	-1620	1"	1 5/16-12	1 5/16-12	51,0	51,0	41,0	50,0
1212789	-2020	1 1/4"	1 5/8-12	1 5/8-12	52,0	52,0	41,0	50,0
1212790	-2424	1 1/2"	1 7/8-12	1 7/8-12	59,0	59,0	48,0	55,0

Dimensions shown may be changed without prior notice

## // R1A25ML305

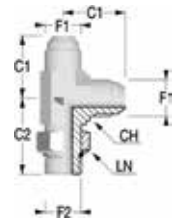
**Run Tee adjustable elbow connector JIC Male - SAE UNF/UN  
Male with O-Ring**

Item Code	Head 1 / Head 2	OD1 in	F1	F2	C1	C2	CH mm	LN mm
	Dash				mm	mm		
1210695	-0404	1/4"	7/16-20	7/16-20	22,5	26,0	12,0	16,0
1212716	-0405	1/4"	7/16-20	1/2-20	24,0	27,5	14,0	17,0
1212717	-0406	1/4"	7/16-20	9/16-18	27,0	31,5	14,0	19,0
1210696	-0505	5/16"	1/2-20	1/2-20	24,0	27,5	14,0	17,0
1207300	-0606	3/8"	9/16-18	9/16-18	27,0	31,5	14,0	19,0
1212718	-0608	3/8"	9/16-18	3/4-16	28,5	36,5	19,0	24,0
1210697	-0808	1/2"	3/4-16	3/4-16	31,5	36,5	19,0	24,0
1212719	-0810	1/2"	3/4-16	7/8-14	34,0	43,0	22,0	27,0
1212720	-0812	1/2"	3/4-16	1 1/16-12	37,0	49,0	27,0	32,0
1212721	-1008	5/8"	7/8-14	3/4-16	36,5	39,5	22,0	24,0
1210698	-1010	5/8"	7/8-14	7/8-14	36,5	43,0	22,0	27,0
1212722	-1012	5/8"	7/8-14	1 1/16-12	39,5	49,0	27,0	32,0
1212723	-1208	3/4"	1 1/16-12	3/4-16	42,0	42,0	27,0	24,0
1212724	-1210	3/4"	1 1/16-12	7/8-14	42,0	45,5	27,0	27,0
1207301	-1212	3/4"	1 1/16-12	1 1/16-12	42,0	49,0	27,0	32,0
1212725	-1216	3/4"	1 1/16-12	1 5/16-12	44,5	52,0	33,0	41,0
1211624	-1616	1"	1 5/16-12	1 5/16-12	46,0	54,6	33,0	41,0
1212727	-1620	1"	1 5/16-12	1 5/8-12	51,0	57,0	41,0	50,0
1211625	-2020	1"1/4	1 5/8-12	1 5/8-12	52,0	57,0	41,0	50,0
1212728	-2424	1"1/2	1 7/8-12	1 7/8-12	59,0	61,0	48,0	55,0

// NPTF

// R1A25M128M

Straight connector JIC - NPTF Male

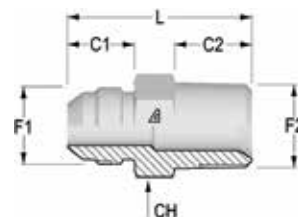

Item Code	Head 1 / Head 2	OD1 in	F1	F2	C1	C2	CH mm	L mm
	Dash				mm	mm		
1203679	-0402	1/4"	7/16-20	1/8-27	14,0	10,0	14,0	31,0
1203678	-0404	1/4"	7/16-20	1/4-18	14,0	14,5	14,0	36,0
1203621	-0502	5/16"	1/2-20	1/8-27	14,0	10,0	14,0	31,0
1203620	-0504	5/16"	1/2-20	1/4-18	14,0	14,5	14,0	36,0
1203704	-0602	3/8"	9/16-18	1/8-27	14,0	10,0	17,0	32,0
1203703	-0604	3/8"	9/16-18	1/4-18	14,0	14,5	17,0	36,5
1203705	-0606	3/8"	9/16-18	3/8-18	14,0	14,5	19,0	36,5
1203702	-0608	3/8"	9/16-18	1/2-14	14,0	19,0	22,0	43,0
1203659	-0804	1/2"	3/4-16	1/4-18	17,0	14,5	19,0	39,0
1203661	-0806	1/2"	3/4-16	3/8-18	17,0	14,5	19,0	39,0
1203658	-0808	1/2"	3/4-16	1/2-14	17,0	19,0	22,0	44,5
1203660	-0812	1/2"	3/4-16	3/4-14	17,0	19,0	27,0	47,0
1212881	-1004	5/8"	7/8-14	1/4-18	19,5	14,5	24,0	43,0
1203691	-1006	5/8"	7/8-14	3/8-18	19,5	14,5	24,0	43,5
1203689	-1008	5/8"	7/8-14	1/2-14	19,5	19,0	24,0	47,0
1203690	-1012	5/8"	7/8-14	3/4-14	19,5	19,0	27,0	49,5
1203608	-1208	3/4"	1 1/16-12	1/2-14	22,0	19,0	27,0	51,5
1203609	-1212	3/4"	1 1/16-12	3/4-14	22,0	19,0	27,0	52,5
1203607	-1216	3/4"	1 1/16-12	1-11 1/2	22,0	24,0	36,0	57,0
1216396	-1412	7/8"	1 3/16-12	3/4-14	22,5	19,0	30,0	53,0
1203633	-1612	1"	1 5/16-12	3/4-14	23,0	19,0	36,0	53,5
1203631	-1616	1"	1 5/16-12	1-11 1/2	23,0	24,0	36,0	58,5
1203642	-2016	1 1/4"	1 5/8-12	1-11 1/2	24,5	24,0	46,0	61,5
1203643	-2020	1 1/4"	1 5/8-12	1 1/4-11 1/2	24,5	24,5	46,0	62,5
1212882	-2420	1 1/2"	1 7/8-12	1 1/4-11 1/2	27,5	24,5	50,0	67,5
1203649	-2424	1 1/2"	1 7/8-12	1 1/2-11 1/2	27,5	25,5	50,0	68,0

Dimensions shown may be changed without prior notice

## // R1A251128M

## Straight connector JIC Female - NPTF Male

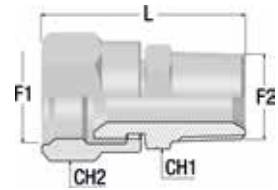

Item Code	Head 1 / Head 2	OD1 in	F1	F2	CH1 mm	CH2 mm	L mm
	Dash						
1210848	-0402	1/4"	7/16-20	1/8-27	16,0	14,0	34,2
1207618	-0404	1/4"	7/16-20	1/4-18	16,0	14,0	39,2
1213170	-0502	5/16"	1/2-20	1/8-27	17,0	14,0	35,5
1207619	-0504	5/16"	1/2-20	1/4-18	17,0	17,0	41,0
1213171	-0602	3/8"	9/16-18	1/8-27	19,0	19,0	37,0
1207620	-0604	3/8"	9/16-18	1/4-18	19,0	17,0	41,0
1207621	-0606	3/8"	9/16-18	3/8-18	19,0	19,0	41,5
1213173	-0804	1/2"	3/4-16	1/4-18	25,0	19,0	44,0
1207622	-0806	1/2"	3/4-16	3/8-18	25,0	-	43,2
1207624	-1008	5/8"	7/8-14	1/2-14	27,0	24,0	50,2
1213174	-1012	5/8"	7/8-14	3/4-14	27,0	30,0	52,5
1207625	-1208	3/4"	1 1/16-12	1/2-14	32,0	27,0	54,3
1207626	-1212	3/4"	1 1/16-12	3/4-14	32,0	30,0	55,3
1216345	-1412	7/8"	1 3/16-12	3/4-14	36,0	30,0	55,2
1207627	-1612	1"	1 5/16-12	3/4-14	38,0	32,0	58,6
1207628	-1616	1"	1 5/16-12	1-11 1/2	38,0	36,0	64,0
1213206	-2020	1 1/4"	1 5/8-12	1 1/4-11 1/2	50,0	46,0	69,4

## // R1A25M428M

## 45° elbow connector JIC - NPTF Male

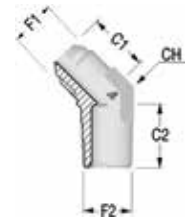

Item Code	Head 1 / Head 2	OD1 in	F1	F2	C1 mm	C2 mm	CH mm
	Dash						
1203920	-0402	1/4"	7/16-20	1/8-27	18,0	16,0	12,0
1203919	-0404	1/4"	7/16-20	1/4-18	21,0	21,5	14,0
1210674	-0504	5/16"	1/2-20	1/4-18	21,0	21,5	14,0
1203925	-0604	3/8"	9/16-18	1/4-18	21,0	21,5	14,0
1203927	-0606	3/8"	9/16-18	3/8-18	22,0	24,0	19,0
1203916	-0806	1/2"	3/4-16	3/8-18	25,0	24,0	19,0
1203915	-0808	1/2"	3/4-16	1/2-14	25,5	29,5	22,0
1212975	-1006	5/8"	7/8-14	3/8-18	28,0	24,5	22,0
1203923	-1008	5/8"	7/8-14	1/2-14	28,0	29,5	22,0
1212976	-1012	5/8"	7/8-14	3/4-14	30,0	30,5	27,0
1203907	-1208	3/4"	1 1/16-12	1/2-14	32,5	30,5	27,0
1203908	-1212	3/4"	1 1/16-12	3/4-14	32,5	30,5	27,0
1203913	-1616	1"	1 5/16-12	1-11 1/2	37,0	37,5	33,0



**// R1A25M928M**

**90° elbow connector JIC - NPTF Male**

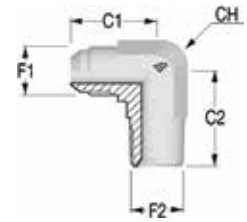

Item Code	Head 1 / Head 2	OD1 in	F1	F2	C1	C2	CH
	Dash				mm	mm	mm
1203872	-0402	1/4"	7/16-20	1/8-27	22,5	19,5	12,0
1203871	-0404	1/4"	7/16-20	1/4-18	27,0	27,5	14,0
1203838	-0502	5/16"	1/2-20	1/8-27	24,0	19,5	14,0
1203837	-0504	5/16"	1/2-20	1/4-18	27,0	27,5	14,0
1203889	-0604	3/8"	9/16-18	1/4-18	27,0	27,5	14,0
1203891	-0606	3/8"	9/16-18	3/8-18	28,5	31,0	19,0
1203888	-0608	3/8"	9/16-18	1/2-14	31,0	37,0	22,0
1203861	-0806	1/2"	3/4-16	3/8-18	31,5	31,0	19,0
1203858	-0808	1/2"	3/4-16	1/2-14	34,0	37,0	22,0
1203860	-0812	1/2"	3/4-16	3/4-14	37,0	40,5	27,0
1203878	-1008	5/8"	7/8-14	1/2-14	36,5	37,0	22,0
1203879	-1012	5/8"	7/8-14	3/4-14	39,5	40,5	27,0
1203831	-1208	3/4"	1 1/16-12	1/2-14	42,0	40,5	27,0
1203832	-1212	3/4"	1 1/16-12	3/4-14	42,0	40,5	27,0
1203843	-1616	1"	1 5/16-12	1-11 1/2	46,0	50,0	33,0
1203851	-2016	1"1/4	1 5/8-12	1-11 1/2	52,0	59,0	41,0
1203852	-2020	1"1/4	1 5/8-12	1 1/4-11 1/2	52,0	60,0	41,0

Dimensions shown may be changed without prior notice

## // ACCESSORIES

## // RXA25D0000

Nut JIC

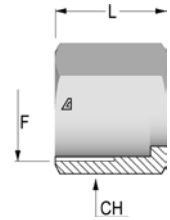

Item Code	Head	OD1	F1	CH	L
	Dash			mm	mm
1208046	-0400	6	7/16-20	14,0	15,80
1208047	-0500	8	1/2-20	17,0	17,30
1207580	-0600	10	9/16-18	19,0	18,80
1208048	-0800	12	3/4-16	22,0	21,80
1208049	-1000	14	7/8-14	27,0	25,10
1208050	-1200	18	1 1/16-12	32,0	26,20
1203514	-1220	20	1 1/16-12	32,0	26,20
1208051	-1600	25	1 5/16-12	41,0	28,70
1208052	-2000	30	1 5/8-12	50,0	31,20
1208053	-2400	38	1 7/8-12	60,0	36,10

## // R1A25R0000

Sleeve JIC



Item Code	Head	OD1	L
	Dash		mm
1203725	-0406	1/4"	10,5
1203719	-0508	5/16"	11,5
1203729	-0610	3/8"	12,5
1203724	-0812	1/2"	14,5
1203726	-1014	5/8"	16,5
1203727	-1015	5/8"	16,5
1203728	-1016	5/8"	16,5
1203717	-1218	3/4"	17,0
1203718	-1220	3/4"	17,0
1216495	-1422	7/8"	19,0
1203720	-1625	1"	19,5
1203721	-2030	1"1/4	23,0
1203722	-2032	1"1/4	23,0
1203723	-2438	1"1/2	28,5

# // FLANGES

## // R1A25M133W

**Straight flange SAE J518 code 61 - JIC - Low pressure**

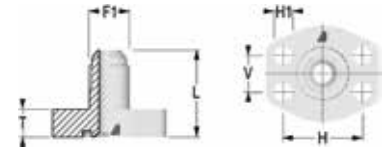

Item Code	Head / Flange	OD1	F1	Flange Size	L	T	H	V	H1
	Dash				in	mm	mm	mm	mm
1212906	-0808	1/2"	3/4-16	1/2	41,0	14,0	38,1	17,5	9,0
1212907	-1008	5/8"	7/8-14	1/2	44,0	14,0	38,1	17,5	9,0
1212908	-1012	5/8"	7/8-14	3/4	47,0	15,0	47,6	22,2	11,0
1212909	-1208	3/4"	1 1/16-12	1/2	46,0	14,0	38,1	17,5	9,0
1212910	-1212	3/4"	1 1/16-12	3/4	49,0	15,0	47,6	22,2	11,0
1212911	-1216	3/4"	1 1/16-12	1	51,0	17,0	52,4	26,2	11,0
1212912	-1612	1"	1 5/16-12	3/4	50,0	15,0	47,6	22,2	11,0
1212913	-1616	1"	1 5/16-12	1	52,0	17,0	52,4	26,2	11,0
1212914	-1620	1"	1 5/16-12	3/4	56,0	21,0	58,7	30,2	11,5
1212915	-2016	1"1/4	1 5/8-12	1	54,0	17,0	52,4	26,2	11,0
1212916	-2020	1"1/4	1 5/8-12	1 1/4	58,0	21,0	58,4	30,2	11,5
1212917	-2024	1"1/4	1 5/8-12	1	64,0	24,0	69,9	35,7	13,5
1212918	-2420	1"1/2	1 7/8-12	1 1/4	61,0	21,0	58,4	30,2	11,5
1212919	-2424	1"1/2	1 7/8-12	1 1/2	67,0	24,0	69,9	35,7	13,5

## // R1A25M136W

**Straight flange SAE J518 code 62 - JIC - High pressure**

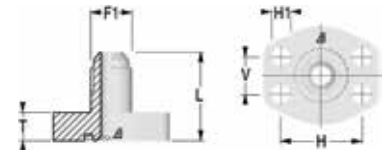

Item Code	Head / Flange	OD1	F1	Flange Size	L	T	H	V	H1
	Dash				in	mm	mm	mm	mm
1212920	-0808	1/2"	3/4-16	1/2	42,0	15,0	40,5	18,2	9,0
1212921	-1008	5/8"	7/8-14	1/2	45,0	15,0	40,5	18,2	9,0
1212922	-1012	5/8"	7/8-14	3/4	49,0	17,0	50,8	23,8	11,0
1212923	-1208	3/4"	1 1/16-12	1/2	47,0	15,0	40,5	18,2	9,0
1212924	-1212	3/4"	1 1/16-12	3/4	51,0	17,0	50,8	23,8	11,0
1212925	-1216	3/4"	1 1/16-12	1	58,0	21,0	57,2	27,8	13,0
1212926	-1612	1"	1 5/16-12	3/4	52,0	17,0	50,8	23,8	11,0
1212927	-1616	1"	1 5/16-12	1	59,0	21,0	57,2	27,8	13,0
1212928	-1620	1"	1 5/16-12	1 1/4	64,0	24,0	66,7	31,8	15,0
1212929	-2016	1"1/4	1 5/8-12	1	61,0	21,0	57,2	27,8	13,0
1212930	-2020	1"1/4	1 5/8-12	1 1/4	66,0	24,0	66,7	31,8	15,0
1212931	-2024	1"1/4	1 5/8-12	1 1/2	70,0	27,0	79,4	36,5	17,0
1212932	-2420	1"1/2	1 7/8-12	1 1/4	69,0	24,0	66,7	31,8	15,0
1212933	-2424	1"1/2	1 7/8-12	1 1/2	73,0	27,0	79,4	36,5	17,0

Dimensions shown may be changed without prior notice

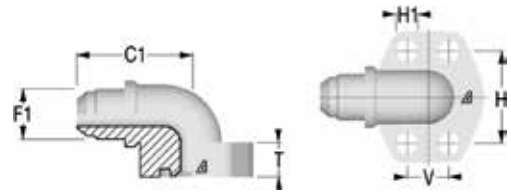
**// R1A25M933W****90° flange SAE J518 code 61 - JIC - Low pressure**

Item Code	Head / Flange	OD1	F1	Flange size	C1	T	H	V	H1
	Dash								
1213085	-0808	1/2"	3/4-16	1/2	40,0	17,0	38,1	17,5	9,0
1213086	-1008	5/8"	7/8-14	1/2	42,0	17,0	38,1	17,5	9,0
1213087	-1012	5/8"	7/8-14	3/4	45,0	20,0	47,6	22,2	11,0
1213088	-1208	3/4"	1 1/16-12	1/2	42,0	20,0	38,1	17,5	9,0
1213089	-1212	3/4"	1 1/16-12	3/4	47,0	20,0	47,6	22,2	11,0
1213090	-1216	3/4"	1 1/16-12	1	50,0	20,0	52,4	26,2	11,0
1213091	-1612	1"	1 5/16-12	3/4	48,0	25,0	47,6	22,2	11,0
1213092	-1616	1"	1 5/16-12	1	51,0	25,0	52,4	26,2	11,0
1213093	-1620	1"	1 5/16-12	1 1/4	56,0	25,0	58,7	30,2	11,5
1213094	-2016	1"1/4	1 5/8-12	1	53,0	31,0	52,4	26,2	11,0
1213095	-2020	1"1/4	1 5/8-12	1 1/4	58,0	31,0	58,4	30,2	11,5
1213096	-2024	1"1/4	1 5/8-12	1 1/2	63,0	31,0	69,9	35,7	13,5
1213097	-2420	1"1/2	1 7/8-12	1 1/4	58,0	37,0	58,4	30,2	11,5
1213098	-2424	1"1/2	1 7/8-12	1 1/2	66,0	37,0	69,9	35,7	13,5

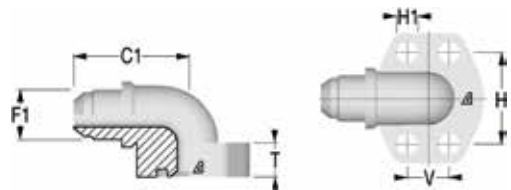
**// R1A25M936W****90° flange SAE J518 code 62 - JIC - High pressure**

Item Code	Head / Flange	OD1	F1	Flange size	C1	T	H	V	H1
	Dash								
1213111	-0808	1/2"	3/4-16	1/2	40,0	17,0	40,5	18,2	9,0
1213112	-1008	5/8"	7/8-14	1/2	42,0	17,0	40,5	18,2	9,0
1213113	-1012	5/8"	7/8-14	3/4	49,0	20,0	50,8	23,8	11,0
1213114	-1208	3/4"	1 1/16-12	1/2	42,0	20,0	40,5	18,2	9,0
1213115	-1212	3/4"	1 1/16-12	3/4	51,0	20,0	50,8	23,8	11,0
1213116	-1216	3/4"	1 1/16-12	1	55,0	25,0	57,2	27,8	13,0
1213117	-1612	1"	1 5/16-12	3/4	52,0	25,0	50,8	23,8	11,0
1213118	-1616	1"	1 5/16-12	1	56,0	25,0	57,2	27,8	13,0
1213119	-1620	1"	1 5/16-12	1 1/4	56,0	31,0	66,7	31,8	15,0
1213120	-2016	1"1/4	1 5/8-12	1	58,0	31,0	57,2	27,8	13,0
1213121	-2020	1"1/4	1 5/8-12	1 1/4	63,0	31,0	66,7	31,8	15,0
1213122	-2024	1"1/4	1 5/8-12	1 1/2	67,0	37,0	79,4	36,5	17,0
1213123	-2420	1"1/2	1 7/8-12	1 1/4	63,0	37,0	66,7	31,8	15,0
1213124	-2424	1"1/2	1 7/8-12	1 1/2	70,0	37,0	79,4	36,5	17,0

**// R1A25M9334**

**90° adjustable split flange SAE J518 code 61 - JIC - Low pressure**

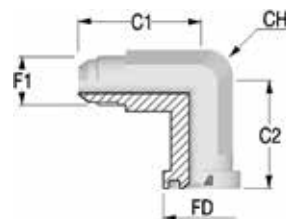

Item Code	Head / Flange	OD1	F1	Flange size	C1	C2	FD	CH
	Dash	in			mm	mm		
1213099	-0808	1/2"	3/4-16	1/2	48,0	42,0	30,2	22,0
1213100	-1008	5/8"	7/8-14	1/2	50,0	44,0	30,2	22,0
1213101	-1012	5/8"	7/8-14	3/4	64,0	53,0	38,1	22,0
1213102	-1212	3/4"	1 1/16-12	3/4	64,0	53,0	38,1	27,0
1213103	-1216	3/4"	1 1/16-12	1	65,0	60,0	44,5	27,0
1213104	-1612	1"	1 5/16-12	3/4	64,0	53,0	38,1	34,0
1213105	-1616	1"	1 5/16-12	1	65,0	60,0	44,5	34,0
1213106	-1620	1"	1 5/16-12	1 1/4	64,0	55,0	50,8	34,0
1213107	-2016	1 1/4"	1 5/8-12	1	65,0	60,0	44,5	42,0
1213108	-2020	1 1/4"	1 5/8-12	1 1/4	64,0	55,0	50,8	42,0
1213109	-2024	1 1/4"	1 5/8-12	1 1/2	78,0	66,0	60,3	42,0
1213110	-2424	1 1/2"	1 7/8-12	1 1/2	78,0	66,0	60,3	50,0

**// R1A25M9364**

**90° adjustable split flange SAE J518 code 62 - JIC - High pressure**

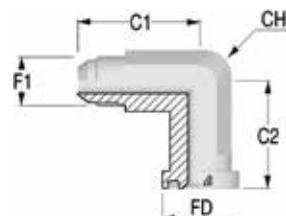

Item Code	Head / Flange	OD1	F1	Flange size	C1	C2	FD	CH
	Dash	in			mm	mm		
1213125	-0808	1/2"	3/4-16	1/2	49,0	43,0	31,8	22,0
1213126	-1008	5/8"	7/8-14	1/2	50,0	44,0	31,8	22,0
1213127	-1012	5/8"	7/8-14	3/4	64,0	53,0	41,3	22,0
1213128	-1212	3/4"	1 1/16-12	3/4	64,0	53,0	41,3	27,0
1213129	-1216	3/4"	1 1/16-12	1	65,0	60,0	47,6	27,0
1213130	-1612	1"	1 5/16-12	3/4	64,0	53,0	41,3	34,0
1213131	-1616	1"	1 5/16-12	1	65,0	60,0	47,6	34,0
1213132	-1620	1"	1 5/16-12	1 1/4	64,0	55,0	54,0	34,0
1213133	-2016	1 1/4"	1 5/8-12	1	65,0	60,0	47,6	42,0
1213134	-2020	1 1/4"	1 5/8-12	1 1/4	64,0	55,0	54,0	42,0
1213135	-2024	1 1/4"	1 5/8-12	1 1/2	78,0	66,0	63,5	42,0
1213136	-2424	1 1/2"	1 7/8-12	1 1/2	78,0	66,0	63,5	50,0



## // ORFS ADAPTERS

// MALE UNION .....	238
// MALE / FEMALE UNION .....	240
// BULKHEAD .....	242
// PLUG.....	245
// BSPP.....	246

// METRIC.....	251 252
// SAE UNF .....	257
// ACCESSORIES .....	262
// FLANGES .....	263

# // MALE UNION

## // R1A2451245

### Straight union ORFS Male

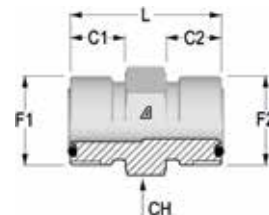

Item Code	Head 1 / Head 2	OD1	F1	F2	C1	C2	CH	L
	Dash							
1207586	-0404	1/4"	9/16-18	9/16-18	10,0	10,0	17,0	27,0
1208173	-0604	3/8"	11/16-16	9/16-18	11,0	10,0	19,0	30,0
1207587	-0606	3/8"	11/16-16	11/16-16	11,0	11,0	19,0	31,0
1208174	-0806	1/2"	13/16-16	11/16-16	13,0	11,0	22,0	33,5
1207579	-0808	1/2"	13/16-16	13/16-16	13,0	13,0	22,0	35,5
1208175	-1008	5/8"	1-14	13/16-16	15,5	13,0	27,0	40,0
1207588	-1010	5/8"	1-14	1-14	15,5	15,5	27,0	42,5
1208176	-1210	3/4"	1 3/16-12	1-14	17,0	15,5	32,0	45,5
1207589	-1212	3/4"	1 3/16-12	1 3/16-12	17,0	17,0	32,0	47,0
1208177	-1612	1"	1 7/16-12	13/16-16	17,5	17,0	41,0	49,5
1207590	-1616	1"	1 7/16-12	1 7/16-12	17,5	17,5	41,0	49,5
1208179	-2016	1"1/4	1 11/16-12	1 7/16-12	17,5	17,5	46,0	51,5
1208180	-2020	1"1/4	1 11/16-12	1 11/16-12	17,5	17,5	46,0	51,5
1211533	-2424	1"1/2	2-12	2-12	17,5	17,5	55,0	53,0

## // R1A2459245

### 90° union ORFS Male

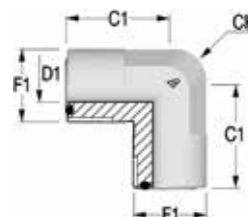

Item Code	Head 1 / Head 2	OD1	F1	C1	CH
	Dash				
1207045	-0404	1/4"	9/16-18	21,5	14,0
1208128	-0606	3/8"	11/16-16	25,0	17,0
1207578	-0808	1/2"	13/16-16	28,0	19,0
1208129	-1010	5/8"	1-14	33,5	27,0
1208130	-1212	3/4"	1 3/16-12	37,5	27,0
1208131	-1616	1"	1 7/16-12	42,0	36,0
1208132	-2020	1"1/4	1 11/16-12	45,0	41,0
1211560	-2424	1"1/2	2-12	49,0	48,0

Dimensions shown may be changed without prior notice

**// R1A245T245**

**Branch Tee union ORFS Male**

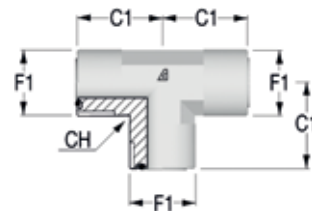

Item Code	Head 1 / Head 2	OD1	F1	C1	CH
	Dash	in		mm	mm
1207600	-0404	1/4"	9/16-18	21,5	14,0
1207601	-0606	3/8"	11/16-16	25,0	17,0
1207572	-0808	1/2"	13/16-16	28,0	19,0
1207571	-1010	5/8"	1-14	33,5	27,0
1208205	-1212	3/4"	1 3/16-12	37,5	27,0
1207602	-1616	1"	1 7/16-12	42,0	36,0
1208206	-2020	1 1/4"	1 11/16-12	45,0	41,0
1211520	-2424	1 1/2"	2-12	49,0	48,0

**// R1A245X245**

**Cross union ORFS Male**

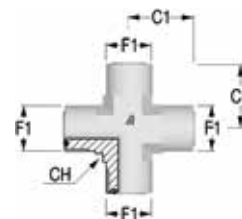

Item Code	Head 1 / Head 2	OD1	F1	C1	CH
	Dash	in		mm	mm
1212531	-0404	1/4"	9/16-18	21,5	14,0
1212532	-0606	3/8"	11/16-16	25,0	17,0
1212533	-0808	1/2"	13/16-16	28,0	19,0
1212534	-1010	5/8"	1-14	33,5	27,0
1212535	-1212	3/4"	1 3/16-12	37,5	27,0
1212536	-1616	1"	1 7/16-12	42,0	36,0
1212537	-2020	1 1/4"	1 11/16-12	45,0	41,0
1212538	-2424	1 1/2"	2-12	49,0	48,0



## // MALE / FEMALE UNION

### // R1A2431245

Straight union ORFS Female - ORFS Male

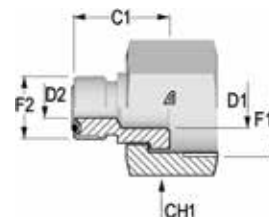

Item Code	Head 1 / Head 2	OD1	F1	F2	C1	CH1
	Dash	in				
1212498	-0604	3/8"	11/16-16	9/16-18	19,5	22,0
1208210	-0804	1/2"	13/16-16	9/16-18	22,0	24,0
1208347	-0806	1/2"	13/16-16	11/16-16	23,0	24,0
1207033	-1004	5/8"	1-14	9/16-18	23,0	30,0
1212518	-1006	5/8"	1-14	11/16-16	24,0	30,0
1207660	-1008	5/8"	1-14	13/16-16	26,0	30,0
1212519	-1204	3/4"	1 3/16-12	9/16-18	25,0	36,0
1208211	-1206	3/4"	1 3/16-12	11/16-16	26,0	36,0
1208212	-1208	3/4"	1 3/16-12	13/16-16	28,0	36,0
1214621	-1210	3/4"	1 3/16-12	1-14	30,5	36,0
1208213	-1608	1"	1 7/16-12	13/16-16	29,5	41,0
1207661	-1610	1"	1 7/16-12	1-14	32,0	41,0
1212499	-1612	1"	1 7/16-12	1 3/16-12	33,5	41,0
1208214	-2012	1 1/4"	1 11/16-12	13/16-16	33,5	50,0
1208037	-2016	1 1/4"	1 11/16-12	1 7/16-12	38,5	50,0
1211497	-2416	1 1/2"	2-12	1 7/16-12	34,0	60,0
1211498	-2420	1 1/2"	2-12	1 11/16-12	34,0	60,0

### // R1A2454241

45° union ORFS Male - ORFS Female

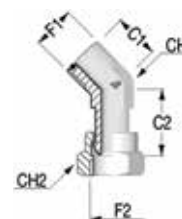

Item Code	Head 1 / Head 2	OD1	F1	C1	C2	CH	CH2
	Dash	in					
1212613	-0404	1/4"	9/16-18	16,0	26,5	14,0	17,0
1212614	-0606	3/8"	11/16-16	19,0	25,0	17,0	22,0
1212615	-0808	1/2"	13/16-16	20,5	30,0	19,0	24,0
1212616	-1010	5/8"	1-14	23,5	40,4	27,0	30,0
1211542	-1212	3/4"	1 3/16-12	26,0	41,0	27,0	36,0
1212617	-1616	1"	1 7/16-12	30,0	45,0	36,0	41,0
1212618	-2020	1 1/4"	1 11/16-12	32,0	45,0	41,0	50,0
1212619	-2424	1 1/2"	2-12	37,0	47,0	48,0	60,0

Dimensions shown may be changed without prior notice

## // R1A2459241

## 90° union ORFS Male - ORFS Female

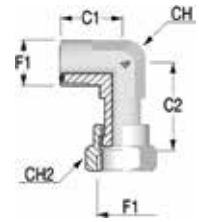

Item Code	Head 1 / Head 2	OD1 in	F1	C1	C2	CH	CH2
	Dash			mm	mm	mm	mm
1208021	-0404	1/4"	9/16-18	21,5	26,5	14,0	17,0
1207593	-0606	3/8"	11/16-16	25,0	29,0	17,0	22,0
1207569	-0808	1/2"	13/16-16	28,0	38,0	19,0	24,0
1206968	-1010	5/8"	1-14	33,5	41,5	27,0	30,0
1207594	-1212	3/4"	1 3/16-12	37,5	46,5	27,0	36,0
1207595	-1616	1"	1 7/16-12	41,5	53,5	36,0	41,0
1208126	-2020	1*1/4	1 11/16-12	44,5	58,0	41,0	50,0
1211559	-2424	1*1/2	2-12	49,0	61,0	48,0	60,0

## // R1A245T241

## Branch Tee union ORFS Male - ORFS Female

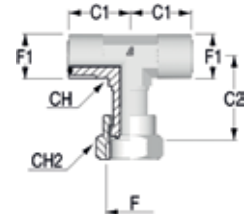

Item Code	Head 1 / Head 2	OD1 in	F1	C1	C2	CH	CH2
	Dash			mm	mm	mm	mm
1208200	-0404	1/4"	9/16-18	21,5	21,5	14,0	17,0
1208033	-0606	3/8"	11/16-16	25,0	25,0	17,0	22,0
1207570	-0808	1/2"	13/16-16	28,0	28,0	19,0	24,0
1208201	-1010	5/8"	1-14	33,5	33,5	27,0	30,0
1208202	-1212	3/4"	1 3/16-12	37,5	37,5	27,0	36,0
1208203	-1616	1"	1 7/16-12	41,5	41,5	36,0	41,0
1208204	-2020	1*1/4	1 11/16-12	44,5	44,5	41,0	50,0
1211519	-2424	1*1/2	2-12	49,0	49,0	48,0	60,0

## // R1A245L241

## Run Tee union ORFS Male - ORFS Female

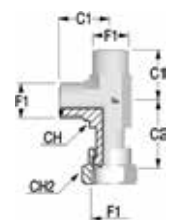

Item Code	Head 1 / Head 2	OD1 in	F1	C1	C2	CH	CH2
	Dash			mm	mm	mm	mm
1207597	-0404	1/4"	9/16-18	21,5	26,5	14,0	17,0
1207573	-0606	3/8"	11/16-16	25,0	29,0	17,0	22,0
1207598	-0808	1/2"	13/16-16	28,0	38,0	19,0	24,0
1207032	-1010	5/8"	1-14	33,5	41,5	27,0	30,0
1207559	-1212	3/4"	1 3/16-12	37,5	46,5	27,0	36,0
1207599	-1616	1"	1 7/16-12	41,5	53,5	36,0	41,0
1208209	-2020	1*1/4	1 11/16-12	44,5	58,0	41,0	50,0
1211508	-2424	1*1/2	2-12	49,0	61,0	48,0	60,0

241

ADAPTERS

# // BULKHEAD

## // R1A245124T

**Straight union ORFS Bulkhead**

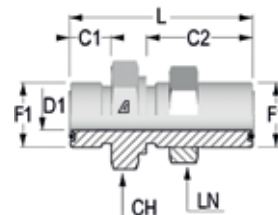

Item Code	Head 1 / Head 2	OD1	F1	C1	C2	CH	LN	L
	Dash							
1208184	-0404	1/4"	9/16-18	10,0	31,5	22,0	22,0	48,0
1207035	-0606	3/8"	11/16-16	11,0	34,0	27,0	27,0	53,0
1208185	-0808	1/2"	13/16-16	13,0	36,5	30,0	30,0	58,0
1239974	-0812	1/2"	13/16-16	13,0	41,5	41,0	41,0	65,0
1206967	-1010	5/8"	1-14	15,5	40,5	36,0	36,0	66,5
1208187	-1212	3/4"	1 3/16-12	17,0	41,5	41,0	41,0	69,0
1208188	-1616	1"	1 7/16-12	17,5	42,0	46,0	46,0	70,0
1208189	-2020	1 1/4"	1 11/16-12	17,5	42,0	50,0	50,0	70,0
1211532	-2424	1 1/2"	2-12	17,5	42,0	60,0	60,0	70,0

## // R1A245424T

**45° union ORFS Bulkhead**

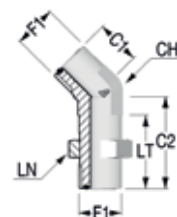

Item Code	Head 1 / Head 2	OD1	F1	C1	C2	CH	LN	LT
	Dash							
1212605	-0404	1/4"	9/16-18	16,0	44,0	14,0	22,0	31,5
1212606	-0606	3/8"	11/16-16	19,0	48,5	17,0	27,0	34,0
1212607	-0808	1/2"	13/16-16	20,5	51,0	19,0	30,0	36,5
1212608	-1010	5/8"	1-14	23,5	56,5	27,0	36,0	40,5
1212609	-1212	3/4"	1 3/16-12	26,0	60,5	27,0	41,0	41,5
1212610	-1616	1"	1 7/16-12	30,0	65,0	36,0	46,0	42,0
1212612	-2424	1 1/2"	2-12	37,0	67,0	48,0	60,0	42,0

Dimensions shown may be changed without prior notice

## // R1A245924T

## 90° union ORFS Bulkhead

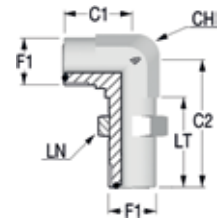

Item Code	Head 1 / Head 2	OD1 in	F1	C1	C2	CH	LN	LT
	Dash			mm	mm	mm	mm	mm
1210753	-0404	1/4"	9/16-18	22,5	47,0	14,0	22,0	31,5
1210754	-0606	3/8"	11/16-16	26,0	52,0	17,0	27,0	34,0
1210755	-0808	1/2"	13/16-16	29,0	55,5	19,0	30,0	36,5
1207560	-1010	5/8"	1-14	34,5	63,0	27,0	36,0	40,5
1208157	-1212	3/4"	1 3/16-12	38,5	67,0	27,0	41,0	41,5
1211557	-1616	1"	1 7/16-12	42,5	71,0	36,0	46,0	42,0
1208158	-2020	1 1/4"	1 11/16-12	45,5	75,5	41,0	50,0	42,0
1211558	-2424	1 1/2"	2-12	49,5	79,5	48,0	60,0	42,0

## // R1A245T24T

## Branch Tee union ORFS Bulkhead

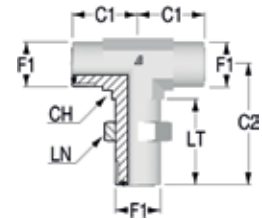

Item Code	Head 1 / Head 2	OD1 in	F1	C1	C2	CH	LN	LT
	Dash			mm	mm	mm	mm	mm
1212524	-0404	1/4"	9/16-18	22,5	22,5	14,0	22,0	31,5
1212525	-0606	3/8"	11/16-16	26,0	26,0	17,0	27,0	34,0
1208224	-0808	1/2"	13/16-16	29,0	29,0	19,0	30,0	36,5
1212526	-1010	5/8"	1-14	34,5	34,5	27,0	36,0	40,5
1212527	-1212	3/4"	1 3/16-12	38,5	38,5	27,0	41,0	41,5
1212528	-1616	1"	1 7/16-12	42,5	42,5	36,0	46,0	42,0
1212529	-2020	1 1/4"	1 11/16-12	45,5	45,5	41,0	50,0	42,0
1212530	-2424	1 1/2"	2-12	49,5	49,5	48,0	60,0	42,0

## // R1A245L24T

## Run Tee union ORFS Bulkhead

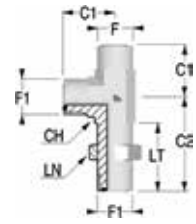

Item Code	Head 1 / Head 2	OD1	F1	C1	C2	CH	LN	LT
	Dash	in		mm	mm	mm	mm	mm
1240057	-0404	1/4"	9/16-18	22,5	47,0	14,0	22,0	35,0
1211502	-0606	3/8"	11/16-16	26,0	52,0	17,0	27,0	39,0
1210797	-0808	1/2"	13/16-16	29,0	55,5	19,0	30,0	40,0
1211503	-1010	5/8"	1-14	34,5	63,0	27,0	36,0	43,5
1211504	-1212	3/4"	1 3/16-12	38,5	67,0	27,0	41,0	44,5
1211505	-1616	1"	1 7/16-12	42,5	71,0	36,0	46,0	46,0
1211506	-2020	1 1/4"	1 11/16-12	45,5	75,5	41,0	50,0	46,5
1211507	-2424	1 1/2"	2-12	49,5	79,5	48,0	60,0	45,0

Dimensions shown may be changed without prior notice

## // PLUG

## // R1A2431000

## Cap ORFS Female

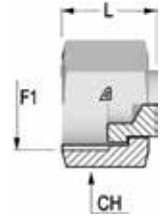

Item Code	Head	OD1	F1	CH	L
	Dash			mm	
1207932	-0400	1/4"	9/16-18	17,0	17,0
1207711	-0600	3/8"	11/16-16	22,0	20,0
1207933	-0800	1/2"	13/16-16	24,0	23,0
1208261	-1000	5/8"	1-14	30,0	27,0
1208260	-1200	3/4"	1 3/16-12	36,0	30,0
1208259	-1600	1"	1 7/16-12	41,0	31,0
1208258	-2000	1 1/4"	1 11/16-12	50,0	31,0
1210844	-2400	1 1/2"	2-12	57,0	31,0

## // R1A2451000

## Plug ORFS Male

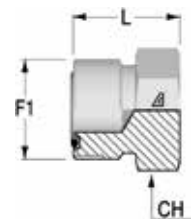

Item Code	Head	OD1	F1	CH	L
	Dash			mm	
1207934	-0400	1/4"	9/16-18	17,0	16,5
1207772	-0600	3/8"	11/16-16	19,0	19,0
1207935	-0800	1/2"	13/16-16	22,0	22,0
1208215	-1000	5/8"	1-14	27,0	26,0
1208216	-1200	3/4"	1 3/16-12	32,0	27,5
1208217	-1600	1"	1 7/16-12	41,0	28,0
1208218	-2000	1 1/4"	1 11/16-12	46,0	28,0
1210824	-2400	1 1/2"	2-12	55,0	28,0

// BSPP

// R1A245106I

**Straight connector ORFS Male - BSPP cylindric Male with elastomer**

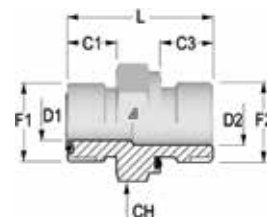

Item Code	Head 1 / Head 2	OD1 in	F1	F2	C1 mm	C2 mm	CH mm	L mm
	Dash							
1207990	-0402	1/4"	9/16-18	1/8-28	10,0	8,0	17,0	25,5
1206956	-0404	1/4"	9/16-18	1/4-19	10,0	12,0	19,0	30,5
1206957	-0406	1/4"	9/16-18	3/8-19	10,0	12,0	22,0	31,5
1208017	-0408	1/4"	9/16-18	1/2-14	10,0	14,0	27,0	35,5
1207575	-0604	3/8"	11/16-16	1/4-19	11,0	12,0	19,0	31,5
1207574	-0606	3/8"	11/16-16	3/8-19	11,0	12,0	22,0	33,5
1207996	-0608	3/8"	11/16-16	1/2-14	11,0	14,0	27,0	37,0
1207998	-0804	1/2"	13/16-16	1/4-19	13,0	12,0	22,0	39,5
1207576	-0806	1/2"	13/16-16	3/8-19	13,0	12,0	22,0	34,5
1206958	-0808	1/2"	13/16-16	1/2-14	13,0	14,0	27,0	38,5
1208022	-0812	1/2"	13/16-16	3/4-14	13,0	16,0	32,0	42,0
1207999	-1006	5/8"	1-14	3/8-19	15,5	12,0	27,0	43,0
1208010	-1008	5/8"	1-14	1/2-14	15,5	14,0	27,0	41,0
1207959	-1012	5/8"	1-14	3/4-14	15,5	16,0	32,0	44,5
1208000	-1208	3/4"	1 3/16-12	1/2-14	17,0	14,0	32,0	48,5
1206955	-1212	3/4"	1 3/16-12	3/4-14	17,0	16,0	32,0	46,0
1211527	-1216	3/4"	1 3/16-12	1-11	17,0	18,0	41,0	49,5
1208003	-1612	1"	1 7/16-12	3/4-14	17,5	16,0	41,0	51,0
1207577	-1616	1"	1 7/16-12	1-11	17,5	18,0	41,0	49,0
1207979	-1620	1"	1 7/16-12	1 1/4-11	17,5	20,0	50,0	54,0
1208034	-2016	1"1/4	1 11/16-12	1-11	17,5	18,0	46,0	57,5
1208018	-2020	1"1/4	1 11/16-12	1 1/4-11	17,5	20,0	50,0	54,0
1211528	-2024	1"1/4	1 11/16-12	1 1/2-11	17,5	22,0	55,0	57,5
1211529	-2424	1"1/2	2-12	1 1/2-11	17,5	22,0	55,0	57,5

Dimensions shown may be changed without prior notice

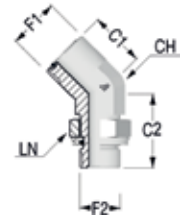
**// R1A245406N****45° adjustable elbow connector ORFS Male - BSPP cylindric  
Male with O-Ring and retaining ring**

Item Code	Head 1 / Head 2	OD1	F1	F2	C1	C2	CH	LN
	Dash	in						
1210800	-0402	1/4"	9/16-18	1/8-28	16,0	28,0	14,0	14,0
1210801	-0404	1/4"	9/16-18	1/4-19	17,5	31,0	14,0	19,0
1210802	-0604	3/8"	11/16-16	1/4-19	19,0	32,0	19,0	19,0
1210803	-0606	3/8"	11/16-16	3/8-19	19,0	33,0	19,0	22,0
1210804	-0608	3/8"	11/16-16	1/2-14	19,5	43,0	27,0	27,0
1210805	-0806	1/2"	13/16-16	3/8-19	20,5	33,5	19,0	22,0
1212604	-0808	1/2"	13/16-16	1/2-14	22,0	42,0	27,0	27,0
1210806	-1008	5/8"	1-14	1/2-14	23,5	42,0	27,0	27,0
1210807	-1012	5/8"	1-14	3/4-14	24,5	46,5	30,0	32,0
1210733	-1212	3/4"	1 3/16-12	3/4-14	26,0	50,0	30,0	36,0
1211539	-1216	3/4"	1 3/16-12	1-11	29,5	52,5	36,0	41,0
1207720	-1616	1"	1 7/16-12	1-11	30,0	52,5	36,0	41,0
1211540	-2020	1"1/4	1 11/16-12	1 1/4-11	32,0	53,5	41,0	50,0
1211541	-2424	1"1/2	2-12	1 1/2-11	37,0	53,5	48,0	55,0



**// R1A245906N**

**90° adjustable elbow connector ORFS Male - BSPP cylindric Male with O-Ring and retaining ring**

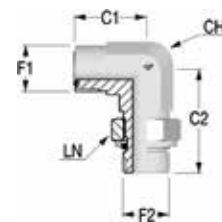

Item Code	Head 1 / Head 2	OD1	F1	F2	C1	C2	CH	LN
	Dash							
1210739	-0402	1/4"	9/16-18	1/8-28	21,5	30,0	14,0	14,0
1207721	-0404	1/4"	9/16-18	1/4-19	23,5	35,0	14,0	19,0
1207581	-0406	1/4"	9/16-18	3/8-19	25,0	38,0	19,0	22,0
1207722	-0604	3/8"	11/16-16	1/4-19	25,0	36,0	19,0	19,0
1207568	-0606	3/8"	11/16-16	3/8-19	26,5	38,0	19,0	22,0
1207567	-0608	3/8"	11/16-16	1/2-14	29,5	48,0	27,0	27,0
1207723	-0804	1/2"	13/16-16	1/4-19	28,0	35,0	19,0	19,0
1207724	-0806	1/2"	13/16-16	3/8-19	28,0	38,0	19,0	22,0
1207725	-0808	1/2"	13/16-16	1/2-14	31,0	48,0	27,0	27,0
1208118	-1006	5/8"	1-14	3/8-19	33,5	43,0	27,0	22,0
1207034	-1008	5/8"	1-14	1/2-14	33,5	48,0	27,0	27,0
1210741	-1012	5/8"	1-14	3/4-14	36,0	51,5	30,0	32,0
1208029	-1208	3/4"	1 3/16-12	1/2-14	37,5	49,5	30,0	27,0
1207557	-1212	3/4"	1 3/16-12	3/4-14	37,5	51,5	30,0	36,0
1208119	-1216	3/4"	1 3/16-12	1-11	41,5	58,0	36,0	41,0
1210714	-1612	1"	1 7/16-12	3/4-14	42,0	56,0	36,0	32,0
1208121	-1616	1"	1 7/16-12	1-11	42,0	58,0	36,0	41,0
1211552	-1620	1"	1 7/16-12	1 1/4-11	45,0	60,5	41,0	50,0
1211553	-2016	1 1/4"	1 11/16-12	1-11	45,0	60,0	41,0	41,0
1211554	-2020	1 1/4"	1 11/16-12	1 1/4-11	45,0	60,5	41,0	50,0
1211555	-2024	1 1/4"	1 11/16-12	1 1/2-11	49,0	64,5	48,0	55,0
1211556	-2424	1 1/2"	2-12	1 1/2-11	49,0	64,5	48,0	55,0

Dimensions shown may be changed without prior notice

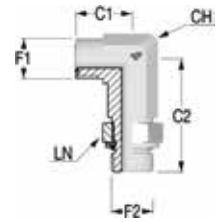
**// R1A245906Y****90° adjustable long elbow connector ORFS Male - BSPP  
cylindric Male with O-Ring and retaining ring**

Item Code	Head 1 / Head 2	OD1 in	F1	F2	C1	C2	CH	LN
	Dash				mm	mm	mm	mm
1212620	-0404	1/4"	9/16-18	1/4-19	23,5	59,0	14,0	19,0
1212621	-0406	1/4"	9/16-18	3/8-19	25,0	62,0	19,0	22,0
1212622	-0606	3/8"	11/16-16	3/8-19	26,5	67,0	19,0	22,0
1212623	-0608	3/8"	11/16-16	1/2-14	29,5	77,0	27,0	27,0
1212624	-0806	1/2"	13/16-16	3/8-19	28,0	73,0	19,0	22,0
1212625	-0808	1/2"	13/16-16	1/2-14	31,0	82,0	27,0	27,0
1212626	-1008	5/8"	1-14	1/2-14	33,5	87,0	27,0	27,0
1212627	-1012	5/8"	1-14	3/4-14	36,0	90,0	30,0	32,0
1212628	-1212	3/4"	1 3/16-12	3/4-14	37,5	97,0	30,0	36,0
1212629	-1216	3/4"	1 3/16-12	1-11	41,5	104,0	36,0	41,0
1212630	-1616	1"	1 7/16-12	1-11	42,0	112,0	36,0	41,0
1212631	-1620	1"	1 7/16-12	1 1/4-11	45,0	113,0	41,0	50,0
1212632	-2020	1 1/4"	1 11/16-12	1 1/4-11	45,0	123,0	41,0	50,0
1212633	-2024	1 1/4"	1 11/16-12	1 1/2-11	49,0	128,0	48,0	55,0
1212634	-2424	1 1/2"	2-12	1 1/2-11	49,0	137,0	48,0	55,0

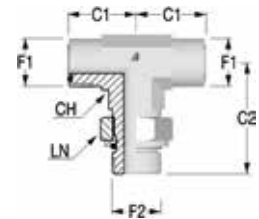
**// R1A245T06N****Branch Tee adjustable elbow connector ORFS Male - BSPP  
cylindric Male with O-Ring and retaining ring**

Item Code	Head 1 / Head 2	OD1 in	F1	F2	C1	C2	CH	LN
	Dash				mm	mm	mm	mm
1210825	-0402	1/4"	9/16-18	9/16-18	21,5	21,5	14,0	14,0
1210826	-0404	1/4"	9/16-18	9/16-18	23,5	23,5	14,0	19,0
1210827	-0604	3/8"	11/16-16	11/16-16	25,0	25,0	19,0	19,0
1210828	-0606	3/8"	11/16-16	11/16-16	26,5	26,5	19,0	22,0
1210829	-0806	1/2"	13/16-16	13/16-16	28,0	28,0	19,0	22,0
1212523	-0808	1/2"	13/16-16	13/16-16	31,0	31,0	27,0	27,0
1207726	-1008	5/8"	1-14	1-14	33,5	33,5	27,0	27,0
1210830	-1012	5/8"	1-14	1-14	36,0	36,0	30,0	32,0
1207558	-1212	3/4"	1 3/16-12	1 3/16-12	37,5	37,5	30,0	36,0
1211516	-1616	1"	1 7/16-12	1 7/16-12	42,0	42,0	36,0	41,0
1211517	-2020	1 1/4"	1 11/16-12	1 11/16-12	45,0	45,0	41,0	50,0
1211518	-2424	1 1/2"	2-12	2-12	49,0	49,0	48,0	55,0

## // R1A245L06N

**Run Tee adjustable elbow connector ORFS Male - BSPP  
cylindric Male with O-Ring and retaining ring**

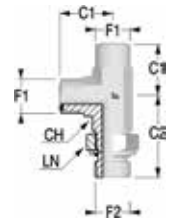

Item Code	Head 1 / Head 2	OD1	F1	F2	C1	C2	CH	LN
	Dash	in						
1210789	-0402	1/4"	9/16-18	1/8-28	21,5	30,0	14,0	14,0
1210791	-0604	3/8"	11/16-16	1/4-19	25,0	36,0	19,0	19,0
1210792	-0606	3/8"	11/16-16	3/8-19	26,5	38,0	19,0	22,0
1211499	-0806	1/2"	13/16-16	3/8-19	28,0	38,0	19,0	22,0
1210793	-0808	1/2"	13/16-16	1/2-14	31,0	48,0	27,0	27,0
1210794	-1008	5/8"	1-14	1/2-14	33,5	48,0	27,0	27,0
1210795	-1012	5/8"	1-14	3/4-14	36,0	51,5	30,0	32,0
1210796	-1212	3/4"	1 3/16-12	3/4-14	37,5	51,5	30,0	36,0
1208208	-1616	1"	1 7/16-12	1-11	42,0	58,0	36,0	41,0
1211500	-2020	1"1/4	1 11/16-12	1 1/4-11	45,0	60,5	41,0	50,0
1211501	-2424	1"1/2	2-12	1 1/2-11	49,0	64,5	48,0	55,0

Dimensions shown may be changed without prior notice

// METRIC

// R1A2451525

Straight connector ORFS Male - Metric Male with O-Ring

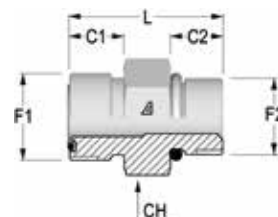

Item Code	Head 1 / Head 2	OD1	F1	F2	C1	C2	CH	L
	Dash							
1216267	-0410	1/4"	9/16-18	M10X1.0	10,0	9,0	17,0	27,0
1216268	-0412	1/4"	9/16-18	M12X1.5	10,0	11,0	17,0	28,5
1208019	-0414	1/4"	9/16-18	M14X1.5	10,0	11,0	19,0	29,5
1207957	-0614	3/8"	11/16-16	M14X1.5	11,0	11,0	22,0	32,0
1208032	-0616	3/8"	11/16-16	M16X1.5	11,0	12,5	22,0	33,5
1216270	-0618	3/8"	11/16-16	M18X1.5	11,0	13,5	24,0	36,0
1207956	-0814	1/2"	13/16-16	M14X1.5	13,0	11,0	22,0	35,0
1216272	-0816	1/2"	13/16-16	M16X1.5	13,0	12,5	22,0	36,5
1208040	-0818	1/2"	13/16-16	M18X1.5	13,0	13,5	24,0	38,0
1211538	-0822	1/2"	13/16-16	M22X1.5	13,0	15,0	27,0	38,5
1208020	-1022	5/8"	1-14	M22X1.5	15,5	15,0	27,0	42,0
1216274	-1027	5/8"	1-14	M27X2	15,5	18,5	32,0	47,0
1216276	-1227	3/4"	1 3/16-12	M27X2	17,0	18,5	32,0	48,5
1216277	-1233	3/4"	1 3/16-12	M33X2.0	17,0	18,5	41,0	51,5
1216278	-1633	1"	1 7/16-12	M33X2.0	17,5	18,5	41,0	52,0
1216279	-1642	1"	1 7/16-12	M42X2	17,5	18,5	50,0	54,5
1216280	-2042	1"1/4	1 11/16-12	M42X2	17,5	18,5	50,0	54,5
1216281	-2048	1"1/4	1 11/16-12	M48X2.0	17,5	18,5	55,0	55,5
1216282	-2448	1"1/2	2-12	M48X2.0	17,5	18,5	55,0	57,0

## // METRIC

## // R1A2451525

## Straight connector ORFS Male - Metric Male with O-Ring

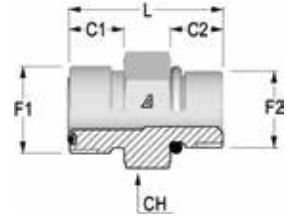

Item Code	Head 1 / Head 2	OD1 in	F1	F2	C1	C2	CH mm	L mm
	Dash				mm	mm		
1216267	-0410	1/4"	9/16-18	M10X1.0	10,0	9,0	17,0	27,0
1216268	-0412	1/4"	9/16-18	M12X1.5	10,0	11,0	17,0	28,5
1208019	-0414	1/4"	9/16-18	M14X1.5	10,0	11,0	19,0	29,5
1207957	-0614	3/8"	11/16-16	M14X1.5	11,0	11,0	22,0	32,0
1208032	-0616	3/8"	11/16-16	M16X1.5	11,0	12,5	22,0	33,5
1216270	-0618	3/8"	11/16-16	M18X1.5	11,0	13,5	24,0	36,0
1207956	-0814	1/2"	13/16-16	M14X1.5	13,0	11,0	22,0	35,0
1216272	-0816	1/2"	13/16-16	M16X1.5	13,0	12,5	22,0	36,5
1208040	-0818	1/2"	13/16-16	M18X1.5	13,0	13,5	24,0	38,0
1211538	-0822	1/2"	13/16-16	M22X1.5	13,0	15,0	27,0	38,5
1208020	-1022	5/8"	1-14	M22X1.5	15,5	15,0	27,0	42,0
1216274	-1027	5/8"	1-14	M27X2	15,5	18,5	32,0	47,0
1216276	-1227	3/4"	1 3/16-12	M27X2	17,0	18,5	32,0	48,5
1216277	-1233	3/4"	1 3/16-12	M33X2.0	17,0	18,5	41,0	51,5
1216278	-1633	1"	1 7/16-12	M33X2.0	17,5	18,5	41,0	52,0
1216279	-1642	1"	1 7/16-12	M42X2	17,5	18,5	50,0	54,5
1216280	-2042	1 1/4"	1 11/16-12	M42X2	17,5	18,5	50,0	54,5
1216281	-2048	1 1/4"	1 11/16-12	M48X2.0	17,5	18,5	55,0	55,5
1216282	-2448	1 1/2"	2-12	M48X2.0	17,5	18,5	55,0	57,0

Dimensions shown may be changed without prior notice

## // R1A245152I

## Straight connector ORFS Male - Metric Male with elastomer

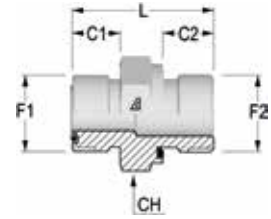

Item Code	Head 1 / Head 2	OD1 in	F1	F2	C1	C2	CH mm	L mm
	Dash				mm	mm		
1206959	-0410	1/4"	9/16-18	M10X1.0	10,0	8,0	17,0	25,0
1206960	-0412	1/4"	9/16-18	M12X1.5	10,0	12,0	17,0	29,5
1208035	-0414	1/4"	9/16-18	M14X1.5	10,0	12,0	19,0	30,5
1208036	-0614	3/8"	11/16-16	M14X1.5	11,0	12,0	22,0	32,0
1206961	-0616	3/8"	11/16-16	M16X1.5	11,0	12,0	22,0	32,0
1212592	-0814	1/2"	13/16-16	M14X1.5	13,0	12,0	22,0	34,0
1216283	-0816	1/2"	13/16-16	M16X1.5	13,0	12,0	22,0	34,0
1206962	-0818	1/2"	13/16-16	M18X1.5	13,0	12,0	24,0	36,5
1212593	-0822	1/2"	13/16-16	M22X1.5	13,0	14,0	27,0	38,5
1208191	-1022	5/8"	1-14	M22X1.5	15,5	14,0	27,0	41,0
1212594	-1222	3/4"	1 3/16-12	M22X1.5	17,0	14,0	32,0	44,0
1208192	-1227	3/4"	1 3/16-12	M27X2	17,0	16,0	32,0	46,0
1211535	-1633	1"	1 7/16-12	M33X2.0	17,5	18,0	41,0	50,0
1212597	-1642	1"	1 7/16-12	M42X2	17,5	20,0	50,0	54,0
1211536	-2042	1"1/4	1 11/16-12	M42X2	17,5	20,0	50,0	54,0
1211537	-2448	1"1/2	2-12	M48X2.0	17,5	22,0	55,0	57,5

**// R1A245452Q**

**45° adjustable elbow connector ORFS Male - Metric Male with O-Ring and retaining ring**

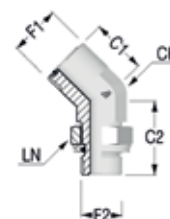

Item Code	Head 1 / Head 2	OD1 in	F1	F2	C1	C2	CH mm	LN mm
	Dash				mm	mm		
1210736	-0412	1/4"	9/16-18	M12X1.5	16,0	30,0	14,0	17,0
1208115	-0616	3/8"	11/16-16	M16X1.5	19,0	33,5	17,0	22,0
1210737	-0818	1/2"	13/16-16	M18X1.5	20,5	37,0	19,0	24,0
1210738	-1022	5/8"	1-14	M22X1.5	23,5	44,0	27,0	27,0
1211548	-1227	3/4"	1 3/16-12	M27X2	26,0	50,5	27,0	32,0
1211549	-1633	1"	1 7/16-12	M33X2.0	30,0	52,5	36,0	41,0
1211550	-2042	1 1/4"	1 11/16-12	M42X2	32,0	54,0	41,0	50,0
1211551	-2448	1 1/2"	2-12	M48X2.0	37,0	56,5	48,0	55,0

**// R1A245952Q**

**90° adjustable elbow connector ORFS Male - Metric Male with O-Ring and retaining ring**

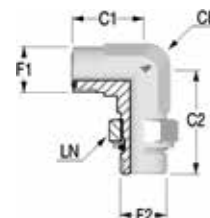

Item Code	Head 1 / Head 2	OD1 in	F1	F2	C1	C2	CH mm	LN mm
	Dash				mm	mm		
1210758	-0410	1/4"	9/16-18	M10X1.0	21,5	32,5	14,0	14,0
1208159	-0412	1/4"	9/16-18	M12X1.5	21,5	33,0	14,0	17,0
1212692	-0612	3/8"	11/16-16	M12X1.5	25,0	35,5	17,0	17,0
1208042	-0614	3/8"	11/16-16	M14X1.5	25,0	35,5	17,0	19,0
1208043	-0616	3/8"	11/16-16	M16X1.5	25,0	37,5	17,0	22,0
1210759	-0818	1/2"	13/16-16	M18X1.5	28,0	41,0	19,0	24,0
1210760	-0822	1/2"	13/16-16	M22X1.5	31,0	49,0	19,0	27,0
1210761	-1022	5/8"	1-14	M22X1.5	33,5	49,0	27,0	27,0
1210762	-1027	5/8"	1-14	M27X2	33,5	55,0	27,0	32,0
1210763	-1227	3/4"	1 3/16-12	M27X2	37,5	55,5	27,0	32,0
1210764	-1233	3/4"	1 3/16-12	M33X2.0	37,5	59,5	36,0	41,0
1212693	-1627	1"	1 7/16-12	M27X2	41,5	59,5	36,0	32,0
1211568	-1633	1"	1 7/16-12	M33X2.0	41,5	59,5	36,0	41,0
1211569	-1642	1"	1 7/16-12	M42X2	41,5	62,0	41,0	50,0
1211570	-2042	1 1/4"	1 11/16-12	M42X2	44,5	63,0	41,0	50,0
1211571	-2048	1 1/4"	1 11/16-12	M48X2.0	44,5	71,5	48,0	55,0
1211572	-2448	1 1/2"	2-12	M48X2.0	49,0	71,5	48,0	55,0

Dimensions shown may be changed without prior notice

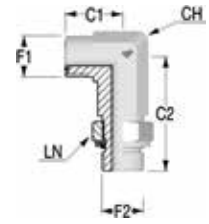
**// R1A245952Y****90° adjustable long elbow connector ORFS Male - Metric Male with O-Ring and retaining ring**

Item Code	Head 1 / Head 2	OD1	F1	F2	C1	C2	CH	LN
	Dash	in						
1212694	-0412	1/4"	9/16-18	M12X1.5	21,5	56,5	14,0	17,0
1212695	-0616	3/8"	11/16-16	M16X1.5	25,0	67,0	17,0	22,0
1212696	-0818	1/2"	13/16-16	M18X1.5	28,0	75,0	19,0	24,0
1212697	-1022	5/8"	1-14	M22X1.5	33,5	89,0	27,0	27,0
1212698	-1227	3/4"	1 3/16-12	M27X2	37,5	100,0	27,0	32,0
1212699	-1633	1"	1 7/16-12	M33X2.0	41,5	113,0	36,0	41,0
1212700	-2042	1 1/4"	1 11/16-12	M42X2	44,5	125,0	41,0	50,0
1212701	-2448	1 1/2"	2-12	M48X2.0	49,0	139,0	48,0	55,0

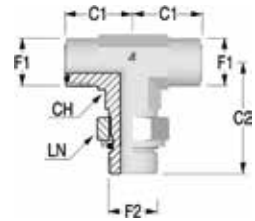
**// R1A245T52Q****Branch Tee adjustable elbow connector ORFS Male - Metric Male with O-Ring and retaining ring**

Item Code	Head 1 / Head 2	OD1	F1	F2	C1	C2	CH	LN
	Dash	in						
1210784	-0412	1/4"	9/16-18	9/16-18	21,5	21,5	14,0	17,0
1210785	-0616	3/8"	11/16-16	11/16-16	25,0	25,0	17,0	22,0
1210786	-0818	1/2"	13/16-16	13/16-16	28,0	28,0	19,0	24,0
1210787	-1022	5/8"	1-14	1-14	33,5	33,5	27,0	27,0
1210788	-1227	3/4"	1 3/16-12	1 3/16-12	37,5	37,5	27,0	32,0
1211524	-1633	1"	1 7/16-12	1 7/16-12	41,5	41,5	36,0	41,0
1211525	-2042	1 1/4"	1 11/16-12	1 11/16-12	44,5	44,5	41,0	50,0
1211526	-2448	1 1/2"	2-12	2-12	49,0	49,0	48,0	55,0



## // R1A245L52Q

Run Tee adjustable elbow connector ORFS Male - Metric Male  
with O-Ring and retaining ring

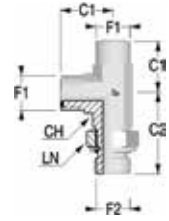

Item Code	Head 1 / Head 2	OD1	F1	F2	C1	C2	CH	LN
	Dash	in						
1210820	-0412	1/4"	9/16-18	M12X1.5	21,5	33,0	14,0	17,0
1210821	-0616	3/8"	11/16-16	M16X1.5	25,0	37,5	17,0	22,0
1210822	-0818	1/2"	13/16-16	M18X1.5	28,0	41,0	19,0	24,0
1210709	-1022	5/8"	1-14	M22X1.5	33,5	49,0	27,0	27,0
1210823	-1227	3/4"	1 3/16-12	M27X2	37,5	55,5	27,0	32,0
1211513	-1633	1"	1 7/16-12	M33X2.0	41,5	59,5	36,0	41,0
1211514	-2042	1"1/4	1 11/16-12	M42X2	44,5	63,0	41,0	50,0
1211515	-2448	1"1/2	2-12	M48X2.0	49,0	71,5	48,0	55,0

Dimensions shown may be changed without prior notice

## // SAE UNF

## // R1A2451305

Straight connector ORFS Male - SAE UNF/UN Male with O-Ring

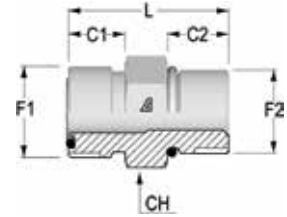

Item Code	Head 1 / Head 2	OD1 in	F1	F2	C1	C2	CH mm	L mm
	Dash				mm	mm		
1206963	-0404	1/4"	9/16-18	7/16-20	10,0	11,0	17,0	29,0
1206964	-0406	1/4"	9/16-18	9/16-18	10,0	12,0	19,0	30,5
1212564	-0604	3/8"	11/16-16	7/16-20	11,0	11,0	19,0	34,0
1207972	-0606	3/8"	11/16-16	9/16-18	11,0	12,0	22,0	32,0
1210723	-0608	3/8"	11/16-16	3/4-16	11,0	14,0	22,0	35,0
1208012	-0806	1/2"	13/16-16	9/16-18	13,0	12,0	22,0	37,5
1208013	-0808	1/2"	13/16-16	3/4-16	13,0	14,0	22,0	36,5
1207973	-0810	1/2"	13/16-16	7/8-14	13,0	16,0	27,0	40,5
1212565	-0812	1/2"	13/16-16	1 1/16-12	13,0	18,5	32,0	44,5
1208014	-1008	5/8"	1-14	3/4-16	15,5	14,0	27,0	45,0
1206965	-1010	5/8"	1-14	7/8-14	15,5	16,0	27,0	43,0
1207968	-1012	5/8"	1-14	1 1/16-12	15,5	18,5	32,0	47,0
1212566	-1210	3/4"	1 3/16-12	7/8-14	17,0	16,0	32,0	50,5
1207592	-1212	3/4"	1 3/16-12	1 1/16-12	17,0	18,5	32,0	48,5
1207561	-1216	3/4"	1 3/16-12	1 5/16-12	17,0	18,5	41,0	50,0
1212567	-1220	3/4"	1 3/16-12	1 5/8-12	17,0	18,5	46,0	50,5
1210721	-1612	1"	1 7/16-12	1 1/16-12	17,5	18,5	41,0	54,0
1208015	-1616	1"	1 7/16-12	1 5/16-12	17,5	18,5	41,0	50,5
1210777	-1620	1"	1 7/16-12	1 5/8-12	17,5	18,5	46,0	52,0
1212568	-2016	1 1/4"	1 11/16-12	1 5/16-12	17,5	18,5	46,0	58,0
1210778	-2020	1 1/4"	1 11/16-12	1 5/8-12	17,5	18,5	46,0	52,0
1211534	-2424	1 1/2"	2-12	1 7/8-12	17,5	18,5	55,0	54,0

## // R1A245130J

Long connector ORFS Male - SAE UNF/UN Male with O-Ring

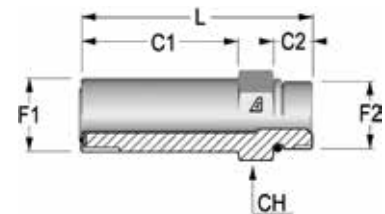

Item Code	Head 1 / Head 2	OD1 in	F1	F2	C1	C2	CH mm	L mm
	Dash				mm	mm		
1212556	-0404	1/4"	9/16-18	7/16-20	34,0	9,0	17,0	52,5
1212557	-0606	3/8"	11/16-16	9/16-18	37,0	10,0	22,0	58,0
1212558	-0808	1/2"	13/16-16	3/4-16	44,0	11,0	22,0	68,0
1212559	-1010	5/8"	1-14	7/8-14	52,0	12,5	27,0	79,5
1212560	-1212	3/4"	1 3/16-12	1 1/16-12	64,0	15,0	32,0	95,5
1212561	-1616	1"	1 7/16-12	1 5/16-12	72,5	15,0	41,0	105,0
1212562	-2020	1 1/4"	1 11/16-12	1 5/8-12	86,0	15,0	46,0	121,0
1212563	-2424	1 1/2"	2-12	1 7/8-12	97,0	15,0	55,0	133,5

**// R1A2454305**

**45° adjustable elbow connector ORFS Male - SAE UNF/UN Male with O-Ring**

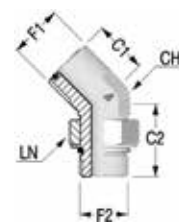

Item Code	Head 1 / Head 2	OD1	F1	F2	C1	C2	CH	LN
	Dash	in			mm	mm	mm	mm
1210808	-0404	1/4"	9/16-18	7/16-20	16,0	30,0	14,0	16,0
1210809	-0406	1/4"	9/16-18	9/16-18	17,5	33,0	14,0	19,0
1210810	-0604	3/8"	11/16-16	7/16-20	19,0	31,0	17,0	16,0
1210722	-0606	3/8"	11/16-16	9/16-18	19,0	33,0	17,0	19,0
1207936	-0608	3/8"	11/16-16	3/4-16	19,0	36,5	19,0	24,0
1210811	-0806	1/2"	13/16-16	9/16-18	20,5	32,5	19,0	19,0
1210812	-0808	1/2"	13/16-16	3/4-16	20,5	36,5	19,0	24,0
1210813	-0810	1/2"	13/16-16	7/8-14	21,0	45,0	22,0	27,0
1211543	-1008	5/8"	1-14	3/4-16	23,5	40,5	27,0	24,0
1210814	-1010	5/8"	1-14	7/8-14	23,5	45,0	27,0	27,0
1210815	-1012	5/8"	1-14	1 1/16-12	24,5	50,0	27,0	32,0
1210816	-1210	3/4"	1 3/16-12	7/8-14	26,0	46,0	30,0	27,0
1207975	-1212	3/4"	1 3/16-12	1 1/16-12	26,0	44,0	27,0	32,0
1211544	-1216	3/4"	1 3/16-12	1 5/16-12	29,5	52,5	36,0	41,0
1207974	-1612	1"	1 7/16-12	1 1/16-12	30,0	51,5	33,0	32,0
1210817	-1616	1"	1 7/16-12	1 5/16-12	30,0	52,5	36,0	41,0
1211545	-1620	1"	1 7/16-12	1 5/8-12	32,0	53,5	41,0	50,0
1211546	-2020	1 1/4"	1 11/16-12	1 5/8-12	32,0	48,5	41,0	50,0
1211547	-2424	1 1/2"	2-12	1 7/8-12	33,5	48,5	48,0	55,0

Dimensions shown may be changed without prior notice

## // R1A2459305

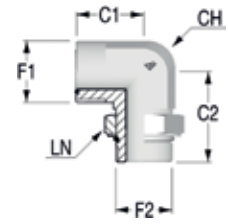
**90° adjustable elbow connector ORFS Male - SAE UNF/UN Male with O-Ring**

Item Code	Head 1 / Head 2	OD1 in	F1	F2	C1	C2	CH	LN
	Dash				mm	mm	mm	mm
1207980	-0404	1/4"	9/16-18	7/16-20	22,5	32,5	14,0	16,0
1207976	-0406	1/4"	9/16-18	9/16-18	23,5	37,0	14,0	19,0
1208016	-0604	3/8"	11/16-16	7/16-20	25,0	35,0	17,0	17,0
1207497	-0606	3/8"	11/16-16	9/16-18	25,0	37,0	17,0	19,0
1210724	-0608	3/8"	11/16-16	3/4-16	26,5	40,5	19,0	24,0
1210725	-0806	1/2"	13/16-16	9/16-18	28,0	36,5	19,0	19,0
1207596	-0808	1/2"	13/16-16	3/4-16	28,0	40,5	19,0	24,0
1207970	-0810	1/2"	13/16-16	7/8-14	31,0	50,0	22,0	27,0
1210726	-1008	5/8"	1-14	3/4-16	33,5	46,0	27,0	24,0
1207971	-1010	5/8"	1-14	7/8-14	33,5	50,0	27,0	27,0
1207969	-1012	5/8"	1-14	1 1/16-12	36,0	55,0	27,0	32,0
1210756	-1210	3/4"	1 3/16-12	7/8-14	37,5	51,0	30,0	27,0
1207977	-1212	3/4"	1 3/16-12	1 1/16-12	37,5	55,0	30,0	32,0
1210711	-1216	3/4"	1 3/16-12	1 5/16-12	41,5	60,0	36,0	41,0
1207978	-1612	1"	1 7/16-12	1 1/16-12	42,0	59,0	33,0	32,0
1210757	-1616	1"	1 7/16-12	1 5/16-12	42,0	60,0	36,0	41,0
1211561	-1620	1"	1 7/16-12	1 5/8-12	45,0	62,0	41,0	50,0
1211562	-2016	1 1/4"	1 11/16-12	1 5/16-12	45,0	62,0	41,0	41,0
1211563	-2020	1 1/4"	1 11/16-12	1 5/8-12	44,5	62,0	41,0	50,0
1211564	-2024	1 1/4"	1 11/16-12	1 7/8-12	49,0	66,0	48,0	55,0
1211565	-2424	1 1/2"	2-12	1 7/8-12	49,0	66,0	48,0	55,0

**// R1A245930J**

**90° adjustable long elbow connector ORFS Male - SAE UNF/UN Male with O-Ring**

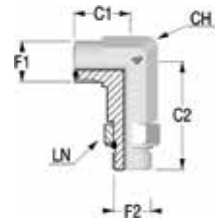

Item Code	Head 1 / Head 2	OD1	F1	F2	C1	C2	CH	LN
	Dash							
1212635	-0404	1/4"	9/16-18	7/16-20	21,5	56,5	14,0	16,0
1212636	-0406	1/4"	9/16-18	9/16-18	23,5	66,0	14,0	19,0
1212637	-0606	3/8"	11/16-16	9/16-18	25,0	66,0	17,0	19,0
1212638	-0608	3/8"	11/16-16	3/4-16	26,5	75,0	19,0	24,0
1212639	-0808	1/2"	13/16-16	3/4-16	28,0	75,0	19,0	24,0
1212640	-0810	1/2"	13/16-16	7/8-14	31,0	89,0	22,0	27,0
1212641	-1010	5/8"	1-14	7/8-14	33,5	89,0	27,0	27,0
1212642	-1012	5/8"	1-14	1 1/16-12	36,0	101,0	27,0	32,0
1212643	-1212	3/4"	1 3/16-12	1 1/16-12	37,5	101,0	30,0	32,0
1212644	-1216	3/4"	1 3/16-12	1 5/16-12	41,5	114,0	36,0	41,0
1212645	-1616	1"	1 7/16-12	1 5/8-12	42,0	114,0	36,0	41,0
1212646	-1620	1"	1 7/16-12	1 5/8-12	45,0	126,0	41,0	50,0
1212647	-2020	1 1/4"	1 11/16-12	1 5/8-12	45,0	126,0	41,0	50,0
1212648	-2024	1 1/4"	1 11/16-12	1 7/8-12	49,0	139,0	48,0	55,0
1212649	-2424	1 1/2"	2-12	1 7/8-12	49,0	139,0	48,0	55,0

**// R1A245T305**

**Branch Tee adjustable elbow connector ORFS Male - SAE UNF/UN Male with O-Ring**

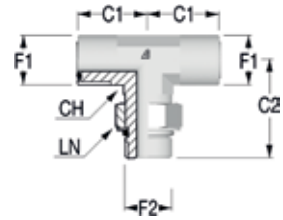

Item Code	Head 1 / Head 2	OD1	F1	F2	C1	C2	CH	LN
	Dash							
1210720	-0404	1/4"	9/16-18	9/16-18	21,5	21,5	14,0	16,0
1210780	-0606	3/8"	11/16-16	11/16-16	25,0	25,0	17,0	19,0
1210781	-0808	1/2"	13/16-16	13/16-16	28,0	28,0	19,0	24,0
1210782	-1010	5/8"	1-14	1-14	33,5	33,5	27,0	27,0
1210783	-1212	3/4"	1 3/16-12	1 3/16-12	37,5	37,5	30,0	32,0
1211521	-1616	1"	1 7/16-12	1 7/16-12	42,0	42,0	36,0	41,0
1211522	-2020	1 1/4"	1 11/16-12	1 11/16-12	45,0	45,0	41,0	50,0
1211523	-2424	1 1/2"	2-12	2-12	49,0	49,0	48,0	55,0

Dimensions shown may be changed without prior notice

## // R1A245L305

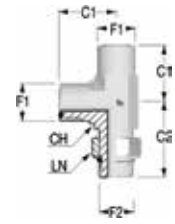
**Run Tee adjustable elbow connector ORFS Male - SAE UNF/UN Male with O-Ring**

Item Code	Head 1 / Head 2	OD1 in	F1	F2	C1 mm	C2 mm	CH mm	LN mm
	Dash							
1210798	-0404	1/4"	9/16-18	7/16-20	21,5	32,5	14,0	16,0
1210799	-0606	3/8"	11/16-16	9/16-18	25,0	37,0	17,0	19,0
1210818	-0808	1/2"	13/16-16	3/4-16	28,0	40,5	19,0	24,0
1210819	-1010	5/8"	1-14	7/8-14	33,5	50,0	27,0	27,0
1211509	-1212	3/4"	1 3/16-12	1 1/16-12	37,5	55,0	30,0	32,0
1211510	-1616	1"	1 7/16-12	1 5/16-12	42,0	60,0	36,0	41,0
1211511	-2020	1 1/4"	1 11/16-12	1 5/8-12	45,0	62,0	41,0	50,0
1211512	-2424	1 1/2"	2-12	1 7/8-12	49,0	66,0	48,0	55,0

## // R1A2411305

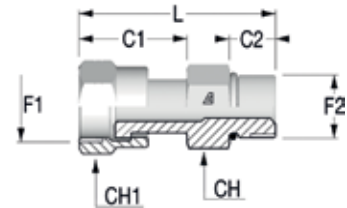
**Straight connector ORFS Female - SAE UNF/UN Male with O-Ring**

Item Code	Head 1 / Head 2	OD1 in	F1	F2	C1 mm	C2 mm	CH mm	CH1 mm	L mm
	Dash/mm								
1212508	-0404	1/4"	9/16-18	7/16-20	24,2	11,0	17,0	19,0	45,0
1212509	-0606	3/8"	11/16-16	9/16-18	27,5	12,0	19,0	22,0	50,0
1212510	-0808	1/2"	13/16-16	3/4-16	33,0	14,0	22,0	24,0	60,0
1208302	-1008	5/8"	1-14	3/4-16	33,0	14,0	24,0	30,0	52,0
1212511	-1010	5/8"	1-14	7/8-14	37,5	16,0	27,0	30,0	67,0
1212512	-1212	3/4"	1 3/16-12	1 1/16-12	41,5	18,5	32,0	36,0	73,5
1212513	-1616	1"	1 7/16-12	1 5/16-12	43,8	18,5	41,0	41,0	82,0
1212514	-2020	1 1/4"	1 11/16-12	1 5/8-12	43,8	18,5	50,0	50,0	82,0
1212515	-2424	1 1/2"	2-12	1 7/8-12	47,5	18,5	55,0	60,0	81,0

## // ACCESSORIES

## // HX0D2403

## Nut ORFS

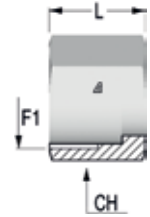

Item Code	Head	OD1 mm	F1	CH	L mm
	Dash			mm	
1223385	-0400	6	9/16-18	17,0	14,50
1221423	-0600	8	11/16-16	22,0	17,00
1209980	-0800	12	13/16-16	24,0	21,00
1209992	-1000	14	1-14	30,0	23,50
1210042	-1200	18	1 3/16-12	36,0	26,00
1217528	-1600	22	1 7/16-12	41,0	28,00
1217529	-2000	28	1 11/16-12	50,0	28,00
1217530	-2400	35	2-12	57,0	28,00

Dimensions shown may be changed without prior notice

## // FLANGES

## // R1A245133W

Straight flange SAE J518 code 61 - ORFS Male - Low pressure

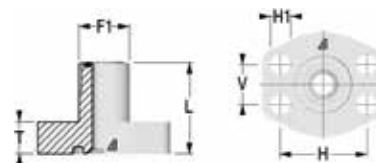

Item Code	Head / Flange	OD1	F1	Flange Size	L	T	H	V	H1
	Dash				in	mm	mm	mm	mm
1212569	-0608	3/8"	11/16-16	1/2	37,0	14,0	38,1	17,5	9,0
1212570	-0808	1/2"	13/16-16	1/2	39,0	14,0	38,1	17,5	9,0
1212571	-1008	5/8"	1-14	1/2	40,0	14,0	38,1	17,5	9,0
1212572	-1012	5/8"	1-14	3/4	44,0	15,0	47,6	22,2	11,0
1212573	-1212	3/4"	1 3/16-12	3/4	45,0	15,0	47,6	22,2	11,0
1212574	-1216	3/4"	1 3/16-12	1	48,0	17,0	52,4	26,2	11,0
1212575	-1616	1"	1 7/16-12	1	49,0	17,0	52,4	26,2	11,0
1212576	-1620	1"	1 7/16-12	1 1/4	55,0	21,0	58,7	30,2	11,5
1212577	-2020	1"1/4	1 11/16-12	1 1/4	55,0	21,0	58,7	30,2	11,5
1212578	-2024	1"1/4	1 11/16-12	1 1/2	59,0	24,0	69,9	35,7	13,5
1212579	-2424	1"1/2	2-12	1 1/2	61,0	24,0	69,9	35,7	13,5

## // R1A245136W

Straight flange SAE J518 code 62 - ORFS Male - High pressure

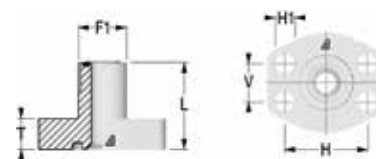

Item Code	Head / Flange	OD1	F1	Flange Size	L	T	H	V	H1
	Dash				in	mm	mm	mm	mm
1212580	-0608	3/8"	11/16-16	1/2	37,0	15,0	40,5	18,2	9,0
1212581	-0808	1/2"	13/16-16	1/2	39,0	15,0	40,5	18,2	9,0
1212582	-1008	5/8"	1-14	1/2	40,0	15,0	40,5	18,2	9,0
1212583	-1012	5/8"	1-14	3/4	44,0	17,0	50,8	23,8	11,0
1212584	-1212	3/4"	1 3/16-12	3/4	45,0	17,0	50,8	23,8	11,0
1212585	-1216	3/4"	1 3/16-12	1	48,0	21,0	57,2	27,8	13,0
1212586	-1616	1"	1 7/16-12	1	49,0	21,0	57,2	27,8	13,0
1212587	-1620	1"	1 7/16-12	1 1/4	55,0	24,0	66,7	31,8	15,0
1212588	-2020	1"1/4	1 11/16-12	1 1/4	55,0	24,0	66,7	31,8	15,0
1212589	-2024	1"1/4	1 11/16-12	1 1/2	59,0	27,0	79,4	36,5	17,0
1212590	-2424	1"1/2	2-12	1 1/2	61,0	27,0	79,4	36,5	17,0



**// R1A245933W**

**90° flange SAE J518 code 61 - ORFS Male - Low pressure**

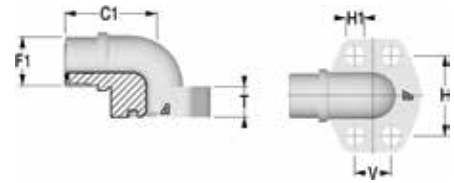

Item Code	Head / Flange	OD1 in	F1	Flange size	C1	T	H	V	H1
	Dash				mm	mm	mm	mm	mm
1212650	-0608	3/8"	11/16-16	1/2	37,0	17,0	38,1	17,5	9,0
1212651	-0808	1/2"	13/16-16	1/2	39,0	17,0	38,1	17,5	9,0
1212652	-1008	5/8"	1-14	1/2	40,0	20,0	38,1	17,5	9,0
1212653	-1012	5/8"	1-14	3/4	44,0	20,0	47,6	22,2	11,0
1212654	-1212	3/4"	1 3/16-12	3/4	45,0	25,0	47,6	22,2	11,0
1212655	-1216	3/4"	1 3/16-12	1	48,0	25,0	52,4	26,2	11,0
1212656	-1616	1"	1 7/16-12	1	49,0	31,0	52,4	26,2	11,0
1212657	-1620	1"	1 7/16-12	1 1/4	55,0	31,0	58,7	30,2	11,5
1212658	-2020	1"1/4	1 11/16-12	1 1/4	55,0	31,0	58,7	30,2	11,5
1212659	-2024	1"1/4	1 11/16-12	1 1/2	59,0	31,0	69,9	35,7	13,5
1212660	-2424	1"1/2	2-12	1 1/2	61,0	37,0	69,9	35,7	13,5

**// R1A245936W**

**90° flange SAE J518 code 62 - ORFS Male - High pressure**

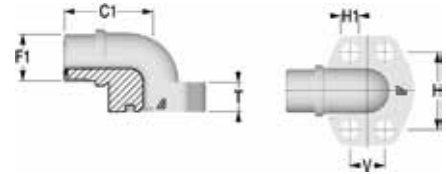

Item Code	Head / Flange	OD1 in	F1	Flange size	C1	T	H	V	H1
	Dash				mm	mm	mm	mm	mm
1212670	-0608	3/8"	11/16-16	1/2	37,0	17,0	40,5	18,2	9,0
1212671	-0808	1/2"	13/16-16	1/2	39,0	17,0	40,5	18,2	9,0
1212672	-1008	5/8"	1-14	1/2	40,0	20,0	40,5	18,2	9,0
1212673	-1012	5/8"	1-14	3/4	44,0	20,0	50,8	23,8	11,0
1212674	-1212	3/4"	1 3/16-12	3/4	45,0	25,0	50,8	23,8	11,0
1212675	-1216	3/4"	1 3/16-12	1	48,0	25,0	57,2	27,8	13,0
1212676	-1616	1"	1 7/16-12	1	49,0	31,0	57,2	27,8	13,0
1212677	-1620	1"	1 7/16-12	1 1/4	55,0	31,0	66,7	31,8	15,0
1212678	-2020	1"1/4	1 11/16-12	1 1/4	55,0	31,0	66,7	31,8	15,0
1212679	-2024	1"1/4	1 11/16-12	1 1/2	59,0	37,0	79,4	36,5	17,0
1212680	-2424	1"1/2	2-12	1 1/2	61,0	37,0	79,4	36,5	17,0

Dimensions shown may be changed without prior notice

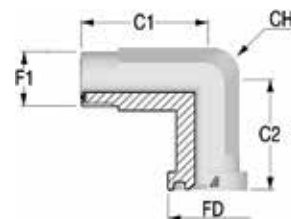
**// R1A2459334****90° adjustable flange SAE J518 code 61 - ORFS Male - Low pressure**

Item Code	Head / Flange	OD1	F1	Flange size	C1	C2	FD	CH
	Dash	in			mm	mm		
1212662	-0808	1/2"	13/16-16	1/2	48,0	42,0	30,2	22,0
1212663	-1008	5/8"	1-14	1/2	50,0	44,0	30,2	22,0
1212664	-1212	3/4"	1 3/16-12	3/4	64,0	53,0	38,1	27,0
1212665	-1616	1"	1 7/16-12	1	65,0	60,0	44,4	34,0
1212666	-1620	1"	1 7/16-12	1 1/4	64,0	55,0	50,8	42,0
1212667	-2020	1 1/4"	1 11/16-12	1 1/4	64,0	55,0	50,8	42,0
1212668	-2024	1 1/4"	1 11/16-12	1 1/2	78,0	66,0	60,3	50,0
1212669	-2424	1 1/2"	2-12	1 1/2	78,0	66,0	60,3	50,0

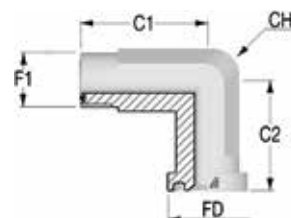
**// R1A2459364****90° adjustable flange SAE J518 code 62 - ORFS Male - High pressure**

Item Code	Head / Flange	OD1	F1	Flange size	C1	C2	FD	CH
	Dash	in			mm	mm		
1212681	-0608	3/8"	11/16-16	1/2	50,0	44,0	31,8	22,0
1212682	-0808	1/2"	13/16-16	1/2	43,0	49,0	31,8	22,0
1212683	-1008	5/8"	1-14	1/2	50,0	44,0	31,8	22,0
1212684	-1012	5/8"	1-14	3/4	64,0	53,0	41,3	27,0
1212685	-1212	3/4"	1 3/16-12	3/4	64,0	53,0	41,3	27,0
1212686	-1216	3/4"	1 3/16-12	1	62,0	60,0	47,6	34,0
1212687	-1616	1"	1 7/16-12	1	62,0	60,0	47,6	34,0
1212688	-1620	1"	1 7/16-12	1 1/4	72,0	70,0	54,0	42,0
1212689	-2020	1 1/4"	1 11/16-12	1 1/4	72,0	70,0	54,0	42,0
1212690	-2024	1 1/4"	1 11/16-12	1 1/2	84,0	80,0	63,5	50,0
1212691	-2424	1 1/2"	2-12	1 1/2	84,0	80,0	63,5	50,0



## // BSP ADAPTERS

// MALE UNION .....	267	// PLUG.....	275
// MALE / FEMALE UNION .....	269	// BSPP.....	276
// FEMALE UNION .....	271	// FLANGES .....	279
// BULKHEAD .....	273		

Dimensions shown may be changed without prior notice

## // MALE UNION

## // R1A05M105M

## Straight union BSP 60° Male

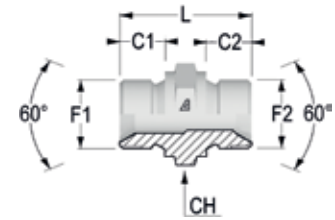

Item Code	Head 1 / Head 2	OD1 in	F1	F2	C1	C2	CH mm	L mm
	Dash				mm	mm		
1203778	-0202	1/8"	1/8-28	1/8-28	8,0	8,0	14,0	25,0
1207670	-0204	1/8"	1/8-28	1/4-19	8,0	11,0	19,0	27,5
1212029	-0206	1/8"	1/8-28	3/8-19	8,0	12,0	22,0	30,0
1212030	-0208	1/8"	1/8-28	1/2-14	8,0	14,0	27,0	33,0
1203775	-0404	1/4"	1/4-19	1/4-19	11,0	11,0	19,0	31,0
1207671	-0406	1/4"	1/4-19	3/8-19	11,0	12,0	22,0	33,5
1207672	-0408	1/4"	1/4-19	1/2-14	11,0	14,0	27,0	36,0
1208335	-0412	1/4"	1/4-19	3/4-14	11,0	16,0	32,0	39,5
1203798	-0606	3/8"	3/8-19	3/8-19	12,0	12,0	22,0	35,0
1207673	-0608	3/8"	3/8-19	1/2-14	12,0	14,0	27,0	37,5
1212031	-0610	3/8"	3/8-19	5/8-14	12,0	16,0	30,0	40,5
1207701	-0612	3/8"	3/8-19	3/4-14	12,0	16,0	32,0	41,0
1212032	-0616	3/8"	3/8-19	1-11	12,0	18,0	41,0	46,0
1203766	-0808	1/2"	1/2-14	1/2-14	14,0	14,0	27,0	40,0
1212033	-0810	1/2"	1/2-14	5/8-14	14,0	16,0	30,0	43,0
1207674	-0812	1/2"	1/2-14	3/4-14	14,0	16,0	32,0	43,5
1212034	-0816	1/2"	1/2-14	1-11	14,0	18,0	41,0	48,0
1212035	-0820	1/2"	1/2-14	1 1/4-11	14,0	20,0	50,0	52,0
1212036	-0824	1/2"	1/2-14	1 1/2-11	14,0	22,0	55,0	56,0
1203803	-1010	5/8"	5/8-14	5/8-14	16,0	16,0	30,0	45,0
1208252	-1012	5/8"	5/8-14	3/4-14	16,0	16,0	32,0	45,5
1205572	-1016	5/8"	5/8-14	1-11	16,0	18,0	41,0	50,0
1212037	-1020	5/8"	5/8-14	1 1/4-11	16,0	20,0	50,0	54,0
1203789	-1212	3/4"	3/4-14	3/4-14	16,0	16,0	32,0	45,5
1207675	-1216	3/4"	3/4-14	1-11	16,0	18,0	41,0	50,0
1208293	-1220	3/4"	3/4-14	1 1/4-11	16,0	20,0	50,0	54,0
1212038	-1224	3/4"	3/4-14	1 1/2-11	16,0	22,0	55,0	58,0
1203747	-1616	1"	1-11	1-11	18,0	18,0	41,0	52,0
1207676	-1620	1"	1-11	1 1/4-11	18,0	20,0	50,0	56,0
1207677	-1624	1"	1-11	1 1/2-11	18,0	22,0	55,0	60,0
1203757	-2020	1 1/4"	1 1/4-11	1 1/4-11	20,0	20,0	50,0	58,0
1208195	-2024	1 1/4"	1 1/4-11	1 1/2-11	20,0	22,0	55,0	62,0
1212040	-2032	1 1/4"	1 1/4-11	2-11	20,0	24,0	70,0	64,5
1203751	-2424	1 1/2"	1 1/2-11	1 1/2-11	22,0	22,0	55,0	64,0
1205940	-2432	1 1/2"	1 1/2-11	2-11	22,0	24,0	70,0	66,5
1203780	-3232	2"	2-11	2-11	24,0	24,0	70,0	69,0

**// R1A05M905M**

**90° union BSP 60° Male**

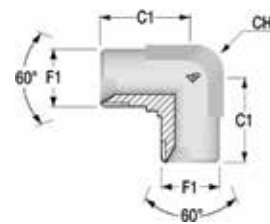

Item Code	Head 1 / Head 2	OD1	F1	C1	CH
	Dash	in		mm	mm
1207905	-0202	1/8"	1/8-28	20,0	12,0
1207505	-0404	1/4"	1/4-19	26,0	14,0
1206438	-0606	3/8"	3/8-19	30,0	17,0
1207542	-0808	1/2"	1/2-14	35,0	22,0
1212187	-1010	5/8"	5/8-14	38,0	22,0
1203905	-1212	3/4"	3/4-14	42,0	27,0
1208198	-1616	1"	1-11	45,5	33,0
1208199	-2020	1 1/4"	1 1/4-11	52,0	41,0
1210968	-2424	1 1/2"	1 1/2-11	60,0	48,0

**// R1A05MT05M**

**Branch Tee union BSP 60° Male**

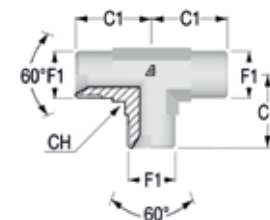

Item Code	Head 1 / Head 2	OD1	F1	C1	CH
	Dash	in		mm	mm
1211959	-0202	1/8"	1/8-28	20,0	12,0
1203955	-0404	1/4"	1/4-19	26,0	14,0
1203956	-0606	3/8"	3/8-19	30,0	17,0
1206940	-0808	1/2"	1/2-14	35,0	22,0
1211960	-1010	5/8"	5/8-14	38,0	22,0
1207236	-1212	3/4"	3/4-14	42,0	27,0
1206450	-1616	1"	1-11	47,0	33,0
1208144	-2020	1 1/4"	1 1/4-11	52,0	41,0
1208145	-2424	1 1/2"	1 1/2-11	60,0	48,0

**// R1A05MX05M**

**Cross union BSP 60° Male**

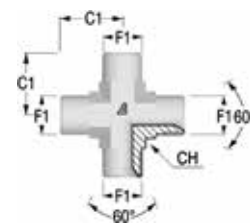

Item Code	Head 1 / Head 2	OD1	F1	C1	CH
	Dash	in		mm	mm
1212021	-0202	1/8"	1/8-28	20,0	12,0
1212022	-0404	1/4"	1/4-19	26,0	14,0
1212023	-0606	3/8"	3/8-19	30,0	17,0
1206941	-0808	1/2"	1/2-14	35,0	22,0
1212024	-1010	5/8"	5/8-14	38,0	22,0
1212025	-1212	3/4"	3/4-14	42,0	27,0
1212026	-1616	1"	1-11	47,0	33,0
1212027	-2020	1 1/4"	1 1/4-11	52,0	41,0
1212028	-2424	1 1/2"	1 1/2-11	60,0	48,0

Dimensions shown may be changed without prior notice

## // MALE / FEMALE UNION

## // R1A05M1051

Straight union BSP 60° Male - Female

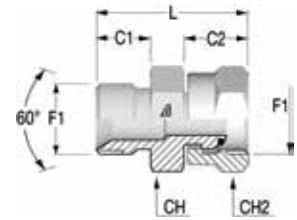

Item Code	Head 1 / Head 2	OD1	F1	C1	C2	CH	CH2	L
	Dash	in		mm	mm	mm	mm	mm
1216217	-0202	1/8"	1/8-28	8,0	13,5	14,0	14,0	29,5
1207697	-0404	1/4"	1/4-19	11,0	15,5	19,0	19,0	30,0
1207698	-0606	3/8"	3/8-19	13,0	17,7	22,0	22,0	33,5
1207699	-0808	1/2"	1/2-14	16,0	19,0	27,0	27,0	40,0
1207700	-1212	3/4"	3/4-14	17,0	22,0	32,0	32,0	42,0
1207686	-1616	1"	1-11	19,0	25,5	41,0	38,0	48,0
1207783	-2020	1"1/4	1 1/4-11	20,0	31,1	50,0	50,0	54,0
1207784	-2424	1"1/2	1 1/2-11	22,0	35,0	55,0	55,0	58,0

## // R1A05M4051

45° union BSP 60° Male - Female

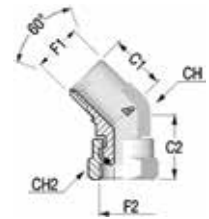

Item Code	Head 1 / Head 2	OD1	F1	C1	C2	CH	CH2
	Dash	in		mm	mm	mm	mm
1212126	-0202	1/8"	1/8-28	16,0	21,0	12,0	14,0
1212145	-0404	1/4"	1/4-19	21,0	25,5	14,0	19,0
1212146	-0606	3/8"	3/8-19	24,0	31,2	17,0	22,0
1207907	-0808	1/2"	1/2-14	27,0	35,5	22,0	27,0
1207786	-1212	3/4"	3/4-14	32,0	39,0	27,0	32,0
1210963	-1616	1"	1-11	35,0	42,5	33,0	38,0
1212148	-2020	1"1/4	1 1/4-11	37,0	44,1	41,0	50,0
1212149	-2424	1"1/2	1 1/2-11	46,0	59,2	48,0	55,0

**// R1A05M9051**

**90° union BSP 60° Male - Female**

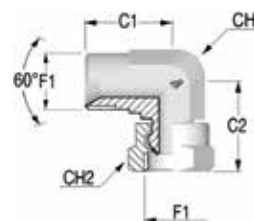

Item Code	Head 1 / Head 2	OD1 in	F1	C1	C2	CH	CH2
	Dash			mm	mm	mm	mm
1218490	-0202	1/8"	1/8-28	22,0	27,0	12,0	14,0
1207702	-0404	1/4"	1/4-19	26,0	30,5	14,0	19,0
1207703	-0606	3/8"	3/8-19	30,0	36,2	17,0	22,0
1207704	-0808	1/2"	1/2-14	35,0	41,5	22,0	27,0
1212219	-1010	5/8"	5/8-14	38,0	47,7	22,0	27,0
1207946	-1212	3/4"	3/4-14	42,0	51,0	27,0	32,0
1207947	-1616	1"	1-11	47,0	54,5	33,0	38,0
1207948	-2020	1 1/4"	1 1/4-11	52,0	59,1	41,0	50,0
1208137	-2424	1 1/2"	1 1/2-11	60,0	73,2	48,0	55,0

**// R1A05ML051**

**Run Tee union BSP 60° Male - Female**

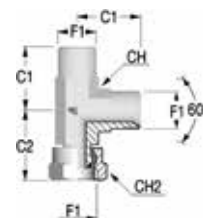

Item Code	Head 1 / Head 2	OD1 in	F1	C1	C2	CH	CH2
	Dash			mm	mm	mm	mm
1211908	-0202	1/8"	1/8-28	22,0	27,0	12,0	14,0
1207787	-0404	1/4"	1/4-19	26,0	30,5	14,0	19,0
1207788	-0606	3/8"	3/8-19	30,0	36,2	17,0	22,0
1207789	-0808	1/2"	1/2-14	35,0	41,5	22,0	27,0
1207790	-1212	3/4"	3/4-14	42,0	51,0	27,0	32,0
1207791	-1616	1"	1-11	47,0	54,5	33,0	38,0
1210946	-2020	1 1/4"	1 1/4-11	52,0	59,1	41,0	50,0
1211921	-2424	1 1/2"	1 1/2-11	60,0	73,2	48,0	55,0

**// R1A05MT051**

**Branch Tee union BSP 60° Male - Female**

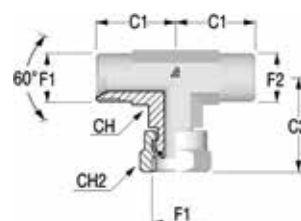

Item Code	Head 1 / Head 2	OD1 in	F1	C1	C2	CH	CH2
	Dash			mm	mm	mm	mm
1211970	-0202	1/8"	1/8-28	22,0	22,0	12,0	14,0
1207705	-0404	1/4"	1/4-19	26,0	26,0	14,0	19,0
1207706	-0606	3/8"	3/8-19	30,0	30,0	17,0	22,0
1207707	-0808	1/2"	1/2-14	35,0	35,0	22,0	27,0
1211982	-1010	5/8"	5/8-14	38,0	38,0	22,0	27,0
1207708	-1212	3/4"	3/4-14	42,0	42,0	27,0	32,0
1207709	-1616	1"	1-11	47,0	47,0	33,0	38,0
1210950	-2020	1 1/4"	1 1/4-11	52,0	52,0	41,0	50,0
1211983	-2424	1 1/2"	1 1/2-11	60,0	60,0	48,0	55,0

Dimensions shown may be changed without prior notice

## // FEMALE UNION

## // R1A0511051

Straight union BSP 60° Female

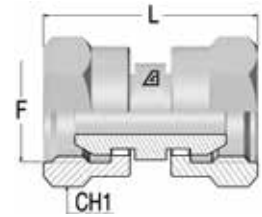

Item Code	Head 1 / Head 2	OD1	F1	F2	CH1	CH2	L
	Dash	in			mm	mm	
1205935	-0404	1/4"	1/4-19	1/4-19	19,0	19,0	30,0
1205934	-0606	3/8"	3/8-19	3/8-19	22,0	22,0	39,0
1205936	-0808	1/2"	1/2-14	1/2-14	27,0	27,0	44,0
1207901	-1212	3/4"	3/4-14	3/4-14	32,0	32,0	50,0
1203738	-1616	1"	1-11	1-11	38,0	38,0	56,0

## // R1A0519051

90° union BSP 60° Female

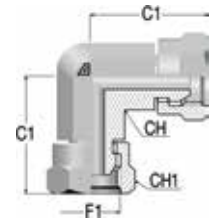

Item Code	Head 1 / Head 2	OD1	F1	C1	CH	CH1
	Dash	in		mm	mm	mm
1224079	-0404	1/4"	1/4-19	30,0	14,0	19,0
1224080	-0606	3/8"	3/8-19	39,0	17,0	22,0
1208320	-0808	1/2"	1/2-14	44,0	22,0	27,0
1224081	-1212	3/4"	3/4-14	50,0	27,0	32,0
1224082	-1616	1"	1-11	56,0	33,0	38,0



**// R1A051T051**

**Branch Tee union BSP 60° Female**

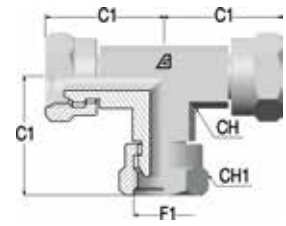

Item Code	Head 1 / Head 2	OD1	F1	C1	CH	CH1
	Dash	in		mm	mm	mm
1218501	-0404	1/4"	1/4-19	30,0	14,0	19,0
1218502	-0606	3/8"	3/8-19	39,0	17,0	22,0
1218503	-0808	1/2"	1/2-14	44,0	22,0	27,0
1206665	-1212	3/4"	3/4-14	50,0	27,0	32,0
1218505	-1616	1"	1-11	56,0	33,0	38,0

**// R1A06AT06A**

**Branch Tee union BSP solid Female**

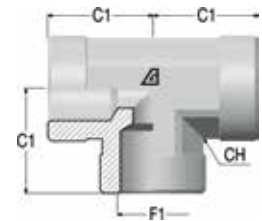

Item Code	Head 1 / Head 2	OD1	F1	C1	CH
	Dash	in		mm	mm

Dimensions shown may be changed without prior notice

## // BULKHEAD

## // R1A05M105T

## Straight union BSP 60° Bulkhead

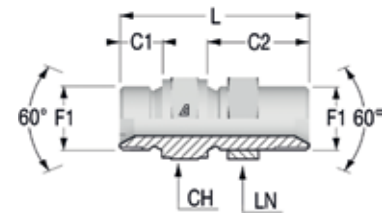

Item Code	Head 1 / Head 2	OD1	F1	C1	C2	CH	LN	L
	Dash							
1212042	-0202	1/8"	1/8-28	9,5	25,0	14,0	14,0	40,5
1207678	-0404	1/4"	1/4-19	13,0	29,0	19,0	19,0	47,0
1207679	-0606	3/8"	3/8-19	14,5	31,0	22,0	22,0	51,5
1207680	-0808	1/2"	1/2-14	17,0	34,0	27,0	27,0	57,0
1207681	-1010	5/8"	5/8-14	19,0	37,0	30,0	32,0	63,0
1207682	-1212	3/4"	3/4-14	19,0	37,0	32,0	32,0	63,5
1207683	-1616	1"	1-11	21,0	41,0	41,0	41,0	72,0
1207684	-2020	1"1/4	1 1/4-11	23,0	45,0	50,0	50,0	80,0
1210955	-2424	1"1/2	1 1/2-11	25,0	49,0	55,0	55,0	88,0

## // R1A05M905T

## 90° elbow connector BSP 60° Bulkhead

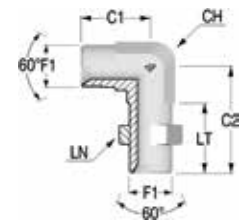

Item Code	Head 1 / Head 2	OD1	F1	C1	C2	CH	LN	LT
	Dash							
1212188	-0202	1/8"	1/8-28	20,0	37,0	12,0	14,0	25,0
1210969	-0404	1/4"	1/4-19	26,0	44,0	14,0	19,0	29,0
1210970	-0606	3/8"	3/8-19	30,0	49,0	17,0	22,0	31,0
1210971	-0808	1/2"	1/2-14	35,0	55,0	22,0	27,0	34,0
1212189	-1010	5/8"	5/8-14	38,0	59,0	22,0	32,0	37,0
1210972	-1212	3/4"	3/4-14	42,0	63,0	27,0	32,0	37,0
1210973	-1616	1"	1-11	47,0	69,0	33,0	41,0	41,0
1210974	-2020	1"1/4	1 1/4-11	52,0	77,0	41,0	50,0	45,0
1210975	-2424	1"1/2	1 1/2-11	60,0	87,0	48,0	55,0	49,0

**// R1A05ML05T**

**Run Tee union BSP 60° Bulkhead**

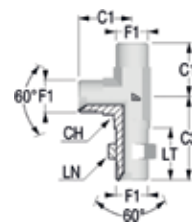

Item Code	Head 1 / Head 2	OD1	F1	C1	C2	CH	LN	LT
	Dash			in				
1211899	-0202	1/8"	1/8-28	20,0	37,0	12,0	14,0	25,0
1211900	-0404	1/4"	1/4-19	26,0	44,0	14,0	19,0	29,0
1211901	-0606	3/8"	3/8-19	30,0	49,0	17,0	22,0	31,0
1211902	-0808	1/2"	1/2-14	35,0	55,0	22,0	27,0	34,0
1211903	-1010	5/8"	5/8-14	38,0	59,0	22,0	32,0	37,0
1211904	-1212	3/4"	3/4-14	42,0	63,0	27,0	32,0	37,0
1211905	-1616	1"	1-11	47,0	69,0	33,0	41,0	41,0
1211906	-2020	1 1/4"	1 1/4-11	52,0	77,0	41,0	50,0	45,0
1211907	-2424	1 1/2"	1 1/2-11	60,0	87,0	48,0	55,0	49,0

**// R1A05MT05T**

**Branch Tee union BSP 60° Bulkhead**

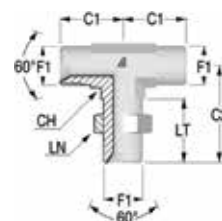

Item Code	Head 1 / Head 2	OD1	F1	C1	C2	CH	LN	LT
	Dash			in				
1211961	-0202	1/8"	1/8-28	20,0	20,0	12,0	14,0	25,0
1211962	-0404	1/4"	1/4-19	26,0	26,0	14,0	19,0	29,0
1211963	-0606	3/8"	3/8-19	30,0	30,0	17,0	22,0	31,0
1211964	-0808	1/2"	1/2-14	35,0	35,0	22,0	27,0	34,0
1211965	-1010	5/8"	5/8-14	38,0	38,0	22,0	32,0	37,0
1211966	-1212	3/4"	3/4-14	42,0	42,0	27,0	32,0	37,0
1211967	-1616	1"	1-11	47,0	47,0	33,0	41,0	41,0
1211968	-2020	1 1/4"	1 1/4-11	52,0	52,0	41,0	50,0	45,0
1211969	-2424	1 1/2"	1 1/2-11	60,0	60,0	48,0	55,0	49,0

Dimensions shown may be changed without prior notice

## // PLUG

## // R1A0531000

## Cap BSP 60° Female

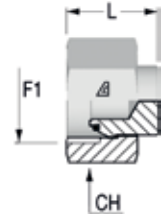

Item Code	Head	OD1	F1	CH	L
	Dash			mm	
1207690	-0400	1/4"	1/4-19	19,0	19,0
1207691	-0600	3/8"	3/8-19	22,0	21,0
1207692	-0800	1/2"	1/2-14	27,0	24,0
1207693	-1000	5/8"	5/8-14	27,0	26,0
1207694	-1200	3/4"	3/4-14	32,0	30,0
1207695	-1600	1"	1-11	38,0	32,0
1207696	-2000	1"1/4	1 1/4-11	50,0	32,0
1210712	-2400	1"1/2	1 1/2-11	55,0	38,0

## // R1A05M1000

## Plug BSP 60° Male

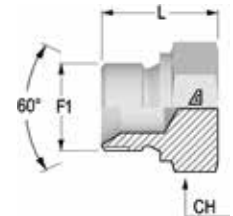

Item Code	Head	OD1	F1	CH	L
	Dash			mm	
1207662	-0200	1/8"	1/8-28	14,0	14,5
1207663	-0400	1/4"	1/4-19	19,0	19,0
1207664	-0600	3/8"	3/8-19	22,0	20,5
1207665	-0800	1/2"	1/2-14	27,0	24,0
1210952	-1000	5/8"	5/8-14	27,0	24,0
1207666	-1200	3/4"	3/4-14	32,0	26,5
1207667	-1600	1"	1-11	41,0	30,0
1207668	-2000	1"1/4	1 1/4-11	50,0	39,0
1207669	-2400	1"1/2	1 1/2-11	55,0	41,0

// BSPP

// R1A05M106N

**Straight connector BSP 60° Male - BSPP cylindric Male with O-Ring and retaining ring**

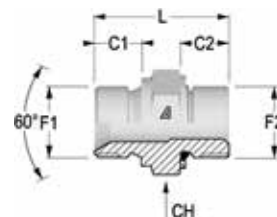

Item Code	Head 1 / Head 2	OD1	F1	F2	C1	C2	CH	L
	Dash							
1212043	-0202	1/8"	1/8-28	1/8-28	9,5	7,5	14,0	21,5
1212044	-0204	1/8"	1/8-28	1/4-19	9,5	11,0	19,0	28,0
1212045	-0404	1/4"	1/4-19	1/4-19	13,0	11,0	19,0	28,0
1212046	-0406	1/4"	1/4-19	3/8-19	13,0	11,0	22,0	31,0
1212047	-0604	3/8"	3/8-19	1/4-19	14,5	11,0	22,0	33,0
1212048	-0606	3/8"	3/8-19	3/8-19	14,5	11,0	22,0	34,0
1212049	-0608	3/8"	3/8-19	1/2-14	14,5	14,5	27,0	38,0
1212050	-0806	1/2"	1/2-14	3/8-19	17,0	11,0	27,0	35,0
1212051	-0808	1/2"	1/2-14	1/2-14	17,0	14,5	27,0	40,0
1212052	-0812	1/2"	1/2-14	3/4-14	17,0	14,5	32,0	40,0
1212053	-1008	5/8"	5/8-14	1/2-14	19,0	14,5	27,0	38,5
1236668	-1208	3/4"	3/4-14	1/2-14	19,0	14,5	32,0	44,0
1212055	-1212	3/4"	3/4-14	3/4-14	19,0	14,5	32,0	46,0
1212056	-1216	3/4"	3/4-14	1-11	19,0	18,5	41,0	52,0
1212057	-1612	1"	1-11	3/4-14	21,0	14,5	41,0	49,0
1212058	-1616	1"	1-11	1-11	21,0	18,5	41,0	55,0
1212059	-1620	1"	1-11	1 1/4-11	21,0	18,5	50,0	60,0
1212060	-2020	1 1/4"	1 1/4-11	1 1/4-11	23,0	18,5	50,0	62,5
1212061	-2424	1 1/2"	1 1/2-11	1 1/2-11	25,0	18,5	55,0	63,0

// R1A05M406N

**45° adjustable elbow connector BSP 60° Male - BSPP cylindric Male with O-Ring and retaining ring**

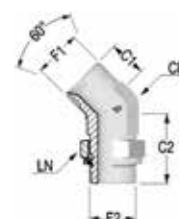

Item Code	Head 1 / Head 2	OD1	F1	F2	C1	C2	CH	LN
	Dash							
1212127	-0202	1/8"	1/8-28	1/8-28	22,0	27,0	12,0	14,0
1212128	-0204	1/8"	1/8-28	1/4-19	24,0	31,5	14,0	19,0
1210962	-0404	1/4"	1/4-19	1/4-19	27,0	31,5	14,0	19,0
1212129	-0406	1/4"	1/4-19	3/8-19	28,0	37,0	17,0	22,0
1212130	-0604	3/8"	3/8-19	1/4-19	29,0	35,0	17,0	19,0
1212131	-0606	3/8"	3/8-19	3/8-19	29,0	37,0	17,0	22,0
1212132	-0608	3/8"	3/8-19	1/2-14	32,0	43,0	19,0	27,0
1212133	-0806	1/2"	1/2-14	3/8-19	34,0	40,0	19,0	22,0
1212134	-0808	1/2"	1/2-14	1/2-14	34,0	43,0	22,0	27,0
1212135	-0810	1/2"	1/2-14	5/8-14	39,0	50,0	27,0	32,0
1212136	-1008	5/8"	5/8-14	1/2-14	37,0	43,0	22,0	27,0
1212137	-1208	3/4"	3/4-14	1/2-14	41,0	46,0	27,0	27,0
1212138	-1212	3/4"	3/4-14	3/4-14	41,0	50,0	27,0	32,0
1212139	-1216	3/4"	3/4-14	1-11	43,0	53,0	33,0	41,0
1212140	-1612	1"	1-11	3/4-14	46,0	52,0	33,0	32,0
1212141	-1616	1"	1-11	1-11	46,0	53,0	33,0	41,0
1212142	-1620	1"	1-11	1 1/4-11	50,0	58,0	41,0	50,0
1212143	-2020	1 1/4"	1 1/4-11	1 1/4-11	51,0	58,0	41,0	50,0
1212144	-2424	1 1/2"	1 1/2-11	1 1/2-11	59,0	67,0	48,0	55,0

Dimensions shown may be changed without prior notice

## // R1A05M906N

90° adjustable elbow connector BSP 60° Male - BSPP cylindric Male with O-Ring and retaining ring

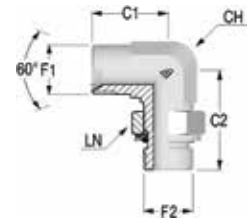

Item Code	Head 1 / Head 2	OD1	F1	F2	C1	C2	CH	LN
	Dash							
1212191	-0202	1/8"	1/8-28	1/8-28	22,0	27,0	12,0	14,0
1212192	-0204	1/8"	1/8-28	1/4-19	24,0	31,5	14,0	19,0
1208135	-0404	1/4"	1/4-19	1/4-19	27,0	31,5	14,0	19,0
1212193	-0406	1/4"	1/4-19	3/8-19	28,0	37,0	17,0	22,0
1212194	-0604	3/8"	3/8-19	1/4-19	29,0	35,0	17,0	19,0
1207949	-0606	3/8"	3/8-19	3/8-19	29,0	37,0	17,0	22,0
1212195	-0608	3/8"	3/8-19	1/2-14	32,0	43,0	19,0	27,0
1212196	-0806	1/2"	1/2-14	3/8-19	34,0	40,0	19,0	22,0
1207950	-0808	1/2"	1/2-14	1/2-14	34,0	43,0	22,0	27,0
1212199	-1208	3/4"	3/4-14	1/2-14	41,0	46,0	27,0	27,0
1208136	-1212	3/4"	3/4-14	3/4-14	41,0	50,0	27,0	32,0
1212200	-1216	3/4"	3/4-14	1-11	43,0	53,0	33,0	41,0
1212201	-1612	1"	1-11	3/4-14	46,0	52,0	33,0	32,0
1210745	-1616	1"	1-11	1-11	46,0	53,0	33,0	41,0
1212202	-1620	1"	1-11	1 1/4-11	50,0	58,0	41,0	50,0
1210976	-2020	1 1/4"	1 1/4-11	1 1/4-11	51,0	58,0	41,0	50,0
1210977	-2424	1 1/2"	1 1/2-11	1 1/2-11	59,0	67,0	48,0	55,0

## // R1A05ML06N

Run Tee adjustable elbow connector BSP 60° Male - BSPP cylindric Male with O-Ring and retaining ring

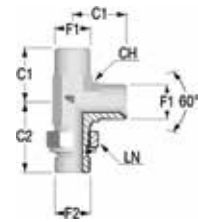

Item Code	Head 1 / Head 2	OD1	F1	F2	C1	C2	CH	LN
	Dash							
1211909	-0202	1/8"	1/8-28	1/8-28	22,0	27,0	12,0	14,0
1211910	-0204	1/8"	1/8-28	1/4-19	24,0	31,5	14,0	19,0
1210746	-0404	1/4"	1/4-19	1/4-19	27,0	31,5	14,0	19,0
1211911	-0406	1/4"	1/4-19	3/8-19	28,0	37,0	17,0	22,0
1211912	-0604	3/8"	3/8-19	1/4-19	29,0	35,0	17,0	19,0
1208140	-0606	3/8"	3/8-19	3/8-19	29,0	37,0	17,0	22,0
1211913	-0608	3/8"	3/8-19	1/2-14	32,0	43,0	19,0	27,0
1211914	-0806	1/2"	1/2-14	3/8-19	34,0	40,0	19,0	22,0
1208141	-0808	1/2"	1/2-14	1/2-14	34,0	43,0	22,0	27,0
1211915	-0810	1/2"	1/2-14	5/8-14	39,0	50,0	27,0	32,0
1211916	-1008	5/8"	5/8-14	1/2-14	37,0	43,0	22,0	27,0
1211917	-1208	3/4"	3/4-14	1/2-14	41,0	46,0	27,0	27,0
1210715	-1212	3/4"	3/4-14	3/4-14	41,0	50,0	27,0	32,0
1211918	-1216	3/4"	3/4-14	1-11	43,0	53,0	33,0	41,0
1211919	-1612	1"	1-11	3/4-14	46,0	52,0	33,0	32,0
1210942	-1616	1"	1-11	1-11	46,0	53,0	33,0	41,0
1210943	-1620	1"	1-11	1 1/4-11	50,0	58,0	41,0	50,0
1210944	-2020	1 1/4"	1 1/4-11	1 1/4-11	51,0	58,0	41,0	50,0
1210945	-2424	1 1/2"	1 1/2-11	1 1/2-11	59,0	67,0	48,0	55,0

**// R1A05MT06N**

**Branch Tee adjustable elbow connector BSP 60° Male - BSPP  
cylindric Male with O-Ring and retaining ring**

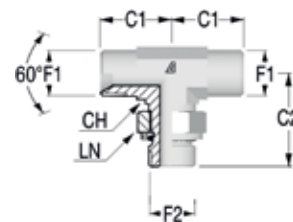

Item Code	Head 1 / Head 2	OD1 in	F1	F2	C1	C2	CH	LN
	Dash				mm	mm	mm	mm
1211971	-0202	1/8"	1/8-28	1/8-28	22,0	22,0	12,0	14,0
1211972	-0204	1/8"	1/8-28	1/8-28	24,0	24,0	14,0	19,0
1208147	-0404	1/4"	1/4-19	1/4-19	27,0	27,0	14,0	19,0
1211973	-0406	1/4"	1/4-19	1/4-19	28,0	28,0	17,0	22,0
1211974	-0604	3/8"	3/8-19	3/8-19	29,0	29,0	17,0	19,0
1210749	-0606	3/8"	3/8-19	3/8-19	29,0	29,0	17,0	22,0
1211976	-0806	1/2"	1/2-14	1/2-14	34,0	34,0	19,0	22,0
1210713	-0808	1/2"	1/2-14	1/2-14	34,0	34,0	22,0	27,0
1211978	-1008	5/8"	5/8-14	5/8-14	37,0	37,0	22,0	27,0
1211979	-1208	3/4"	3/4-14	3/4-14	41,0	41,0	27,0	27,0
1210750	-1212	3/4"	3/4-14	3/4-14	41,0	41,0	27,0	32,0
1211980	-1216	3/4"	3/4-14	3/4-14	43,0	43,0	33,0	41,0
1211981	-1612	1"	1-11	1-11	46,0	46,0	33,0	32,0
1210947	-1616	1"	1-11	1-11	46,0	46,0	33,0	41,0
1207710	-1620	1"	1-11	1-11	50,0	50,0	41,0	50,0
1210948	-2020	1"1/4	1 1/4-11	1 1/4-11	51,0	51,0	41,0	50,0
1210949	-2424	1"1/2	1 1/2-11	1 1/2-11	59,0	59,0	48,0	55,0

Dimensions shown may be changed without prior notice

## // FLANGES

## // R1A05M133W

Straight flange SAE J518 code 61 - BSP - Low pressure

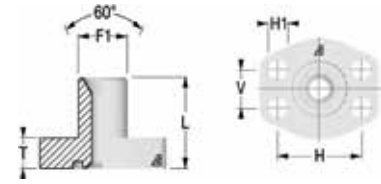

Item Code	Head / Flange	OD1	F1	Flange Size	L	T	H	V	H1
	Dash				in	mm	mm	mm	mm
1212081	-0608	3/8"	3/8-19	1/2	37,0	14,0	38,1	17,5	9,0
1212082	-0808	1/2"	1/2-14	1/2	39,0	14,0	38,1	17,5	9,0
1212083	-0812	1/2"	1/2-14	3/4	42,0	15,0	47,6	22,2	11,0
1212084	-1208	3/4"	3/4-14	1/2	42,0	14,0	38,1	17,5	9,0
1212085	-1212	3/4"	3/4-14	3/4	45,0	15,0	47,6	22,2	11,0
1212086	-1216	3/4"	3/4-14	1	47,0	17,0	52,4	26,2	11,0
1212087	-1612	1"	1-11	3/4	47,0	15,0	47,6	22,2	11,0
1212088	-1616	1"	1-11	1	53,0	21,0	58,7	30,2	11,5
1212089	-2016	1"1/4	1 1/4-11	1	49,0	17,0	52,4	26,2	11,0
1212090	-2020	1"1/4	1 1/4-11	1 1/4	53,0	21,0	58,7	30,2	11,5
1212091	-2024	1"1/4	1 1/4-11	1 1/2	59,0	24,0	69,9	35,7	13,5
1212092	-2420	1"1/2	1 1/2-11	1 1/4	55,0	21,0	58,7	30,2	11,5
1212093	-2424	1"1/2	1 1/2-11	1 1/2	61,0	24,0	69,9	35,7	13,5

## // R1A05M136W

Straight flange SAE J518 code 62 - BSP - High pressure

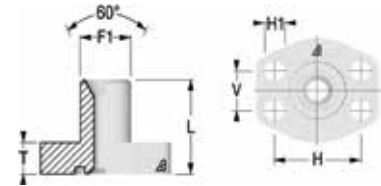

Item Code	Head / Flange	OD1	F1	Flange Size	L	T	H	V	H1
	Dash				in	mm	mm	mm	mm
1212094	-0608	3/8"	3/8-19	1/2	37,0	14,0	38,1	17,5	9,0
1212095	-0808	1/2"	1/2-14	1/2	39,0	14,0	38,1	17,5	9,0
1212096	-0812	1/2"	1/2-14	3/4	42,0	15,0	47,6	22,2	11,0
1212097	-1208	3/4"	3/4-14	1/2	42,0	14,0	38,1	17,5	9,0
1212098	-1212	3/4"	3/4-14	3/4	45,0	15,0	47,6	22,2	11,0
1212099	-1216	3/4"	3/4-14	1	47,0	17,0	52,4	26,2	11,0
1212100	-1612	1"	1-11	3/4	47,0	15,0	47,6	22,2	11,0
1212101	-1616	1"	1-11	1	49,0	17,0	52,4	26,2	11,0
1212102	-1620	1"	1-11	1 1/4	53,0	21,0	58,7	30,2	11,5
1212103	-2016	1"1/4	1 1/4-11	1	49,0	17,0	52,4	26,2	11,0
1212104	-2020	1"1/4	1 1/4-11	1 1/4	53,0	21,0	58,7	30,2	11,5
1212105	-2024	1"1/4	1 1/4-11	1 1/2	59,0	24,0	69,9	35,7	13,5
1212106	-2420	1"1/2	1 1/2-11	1 1/4	55,0	21,0	58,7	30,2	11,5
1212107	-2424	1"1/2	1 1/2-11	1 1/2	61,0	24,0	69,9	35,7	13,5



**// R1A05M933W**

**90° flange SAE J518 code 61 - BSP - Low pressure**

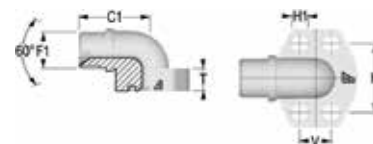

Item Code	Head / Flange	OD1	F1	Flange size	C1	T	H	V	H1
	Dash								
1212252	-0608	3/8"	3/8-19	1/2	37,0	17,0	38,1	17,5	9,0
1212253	-0808	1/2"	1/2-14	1/2	39,0	17,0	38,1	17,5	9,0
1212254	-0812	1/2"	1/2-14	3/4	41,0	20,0	47,6	22,2	11,0
1212255	-1208	3/4"	3/4-14	1/2	40,0	20,0	38,1	17,5	9,0
1212256	-1212	3/4"	3/4-14	3/4	44,0	20,0	47,6	22,2	11,0
1212257	-1216	3/4"	3/4-14	1	47,0	20,0	52,4	26,2	11,0
1212258	-1612	1"	1-11	3/4	45,0	25,0	47,6	22,2	11,0
1212259	-1616	1"	1-11	1	48,0	25,0	52,4	26,2	11,0
1212260	-1620	1"	1-11	1 1/4	54,0	25,0	58,7	30,2	11,5
1212261	-2016	1"1/4	1 1/4-11	1	49,0	31,0	52,4	26,2	11,0
1212262	-2020	1"1/4	1 1/4-11	1 1/4	55,0	31,0	58,7	30,2	11,5
1212263	-2024	1"1/4	1 1/4-11	1 1/2	59,0	31,0	69,9	35,7	13,5
1212264	-2420	1"1/2	1 1/2-11	1 1/4	56,0	37,0	58,7	30,2	11,5
1212265	-2424	1"1/2	1 1/2-11	1 1/2	61,0	37,0	69,9	35,7	13,5

**// R1A05M936W**

**90° flange SAE J518 code 62 - BSP - High pressure**

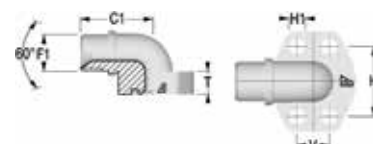

Item Code	Head / Flange	OD1	F1	Flange size	C1	T	H	V	H1
	Dash								
1212278	-0608	3/8"	3/8-19	1/2	37,0	17,0	38,1	17,5	9,0
1212279	-0808	1/2"	1/2-14	1/2	39,0	17,0	38,1	17,5	9,0
1212280	-0812	1/2"	1/2-14	3/4	41,0	20,0	47,6	22,2	11,0
1212281	-1208	3/4"	3/4-14	1/2	40,0	20,0	38,1	17,5	9,0
1212282	-1212	3/4"	3/4-14	3/4	44,0	20,0	47,6	22,2	11,0
1212283	-1216	3/4"	3/4-14	1	47,0	20,0	52,4	26,2	11,0
1212284	-1612	1"	1-11	3/4	45,0	25,0	47,6	22,2	11,0
1212285	-1616	1"	1-11	1	48,0	25,0	52,4	26,2	11,0
1212286	-1620	1"	1-11	1 1/4	54,0	25,0	58,7	30,2	11,5
1212287	-2016	1"1/4	1 1/4-11	1	49,0	31,0	52,4	26,2	11,0
1212288	-2020	1"1/4	1 1/4-11	1 1/4	55,0	31,0	58,7	30,2	11,5
1212289	-2024	1"1/4	1 1/4-11	1 1/2	59,0	31,0	69,9	35,7	13,5
1212290	-2420	1"1/2	1 1/2-11	1 1/4	56,0	37,0	58,7	30,2	11,5
1212291	-2424	1"1/2	1 1/2-11	1 1/2	61,0	37,0	69,9	35,7	13,5

Dimensions shown may be changed without prior notice

## // R1A05M9334

90° adjustable flange SAE J518 code 61 - BSP - Low pressure

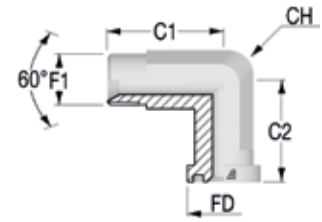

Item Code	Head / Flange	OD1	F1	Flange size	C1	C2	FD	CH
	Dash	in						
1212266	-0608	3/8"	3/8-19	1/2	44,0	50,0	30,2	22,0
1212267	-0808	1/2"	1/2-14	1/2	48,0	42,0	30,2	22,0
1212268	-0812	1/2"	1/2-14	3/4	53,0	64,0	38,1	22,0
1212269	-1212	3/4"	3/4-14	3/4	53,0	64,0	38,1	27,0
1212270	-1216	3/4"	3/4-14	1	60,0	65,0	44,5	27,0
1212271	-1612	1"	1-11	3/4	53,0	64,0	38,1	34,0
1212272	-1616	1"	1-11	1	60,0	65,0	44,5	34,0
1212273	-1620	1"	1-11	1 1/4	55,0	64,0	50,8	34,0
1212274	-2016	1 1/4"	1 1/4-11	1	60,0	65,0	44,5	42,0
1212275	-2020	1 1/4"	1 1/4-11	1 1/4	55,0	64,0	50,8	42,0
1212276	-2024	1 1/4"	1 1/4-11	1 1/2	66,0	78,0	60,3	42,0
1212277	-2424	1 1/2"	1 1/2-11	1 1/2	66,0	78,0	60,3	50,0

## // R1A05M9364

90° adjustable flange SAE J518 code 62 - BSP - High pressure

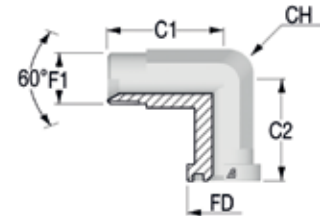

Item Code	Head / Flange	OD1	F1	Flange size	C1	C2	FD	CH
	Dash	in						
1212292	-0608	3/8"	3/8-19	1/2	44,0	50,0	31,8	22,0
1212293	-0808	1/2"	1/2-14	1/2	49,0	43,0	31,8	22,0
1212294	-0812	1/2"	1/2-14	3/4	53,0	64,0	41,3	22,0
1212295	-1212	3/4"	3/4-14	3/4	53,0	64,0	41,3	27,0
1212296	-1216	3/4"	3/4-14	1	60,0	62,0	47,6	27,0
1212297	-1612	1"	1-11	3/4	59,5	54,5	41,3	30,0
1212298	-1616	1"	1-11	1	60,0	62,0	47,6	34,0
1212299	-1620	1"	1-11	1 1/4	70,0	72,0	54,0	34,0
1212300	-2016	1 1/4"	1 1/4-11	1	72,0	70,0	47,6	41,0
1212301	-2020	1 1/4"	1 1/4-11	1 1/4	70,0	72,0	54,0	42,0
1212302	-2024	1 1/4"	1 1/4-11	1 1/2	80,0	84,0	63,5	42,0
1212303	-2424	1 1/2"	1 1/2-11	1 1/2	80,0	84,0	63,5	50,0



## // DIN 24° ADAPTERS

// MALE UNION .....	283	// BSPP.....	310
// MALE / FEMALE UNION .....	287	// BUTT WELD.....	321
// BULKHEAD .....	297	// ACCESSORIES .....	323
// METRIC.....	299	// PLUG.....	325

Dimensions shown may be changed without prior notice

## // MALE UNION

## // R1A11M111M

## Straight union DIN 24° Male - Light series

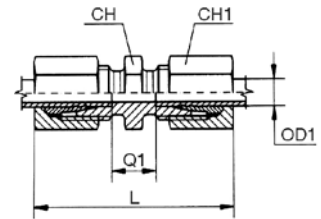

Item Code	Head 1 / Head 2	OD1	Q1	CH	CH1	L
	mm	mm	mm	mm	mm	mm
1205544	-0606	6	10,0	12,0	14,0	39,0
1205546	-0808	8	11,0	14,0	17,0	40,0
1205537	-1010	10	13,0	17,0	19,0	42,0
1204233	-1212	12	14,0	19,0	22,0	43,0
1204234	-1515	15	16,0	24,0	27,0	46,0
1205538	-1818	18	16,0	27,0	32,0	48,0
1205541	-2222	22	20,0	32,0	36,0	52,0
1205708	-2828	28	21,0	41,0	41,0	54,0
1205709	-3535	35	20,0	46,0	50,0	63,0
1205710	-4242	42	21,0	55,0	60,0	66,0

## // R1A12M112M

## Straight union DIN 24° Male - Heavy series

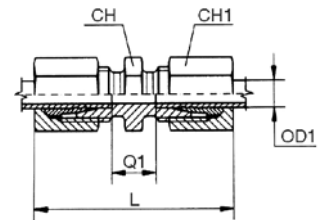

Item Code	Head 1 / Head 2	OD1	Q1	CH	CH1	L
	mm	mm	mm	mm	mm	mm
1206097	-0606	6	16,0	14,0	17,0	45,0
1205687	-0808	8	18,0	17,0	19,0	47,0
1205688	-1010	10	17,0	19,0	22,0	49,0
1205689	-1212	12	19,0	22,0	24,0	51,0
1205690	-1414	14	22,0	24,0	27,0	57,0
1205691	-1616	16	21,0	27,0	30,0	57,0
1205539	-2020	20	23,0	32,0	36,0	66,0
1205542	-2525	25	26,0	41,0	46,0	74,0
1205543	-3030	30	27,0	46,0	50,0	80,0
1205711	-3838	38	29,0	55,0	60,0	90,0

**// R1A11M911M**

**90° union DIN 24° Male - Light series**

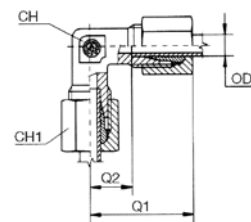

Item Code	Head 1 / Head 2	OD1	Q1	Q2	CH	CH1
	mm	mm	mm	mm	mm	mm
1205692	-0606	6	27,0	12,0	12,0	14,0
1205693	-0808	8	29,0	14,0	12,0	17,0
1205694	-1010	10	30,0	15,0	14,0	19,0
1204062	-1212	12	32,0	17,0	17,0	22,0
1204064	-1515	15	36,0	21,0	19,0	27,0
1205695	-1818	18	40,0	23,5	24,0	32,0
1205696	-2222	22	44,0	27,5	27,0	36,0
1205697	-2828	28	47,0	30,5	36,0	41,0
1205707	-3535	35	56,0	34,5	41,0	50,0
1206043	-4242	42	63,0	40,0	50,0	60,0

**// R1A12M912M**

**90° union DIN 24° Male - Heavy series**

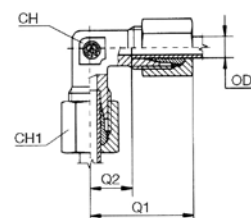

Item Code	Head 1 / Head 2	OD1	Q1	Q2	CH	CH1
	mm	mm	mm	mm	mm	mm
1205698	-0606	6	31,0	16,0	12,0	17,0
1205699	-0808	8	32,0	17,0	14,0	19,0
1205700	-1010	10	34,0	17,5	17,0	22,0
1205701	-1212	12	38,0	21,5	17,0	24,0
1205702	-1414	14	40,0	22,0	19,0	27,0
1205703	-1616	16	43,0	24,5	24,0	30,0
1205704	-2020	20	48,0	26,5	27,0	36,0
1242137	-2525	25	54,0	30,0	36,0	46,0
1205706	-3030	30	62,0	35,5	41,0	50,0
1207042	-3838	38	72,0	41,0	50,0	60,0

Dimensions shown may be changed without prior notice

## // R1A11MT11M

## Branch Tee union DIN 24° Male - Light series

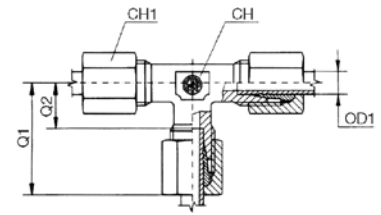

Item Code	Head 1 / Head 2	OD1	Q1	Q2	CH	CH1
	mm	mm	mm	mm	mm	mm
1204218	-0606	6	27,0	12,0	12,0	14,0
1204219	-0808	8	29,0	14,0	12,0	17,0
1204215	-1010	10	30,0	15,0	14,0	19,0
1204216	-1212	12	32,0	17,0	17,0	22,0
1204217	-1515	15	36,0	21,0	19,0	27,0
1205712	-1818	18	40,0	23,5	24,0	32,0
1205713	-2222	22	44,0	27,5	27,0	36,0
1205714	-2828	28	47,0	30,5	36,0	41,0
1205715	-3535	35	56,0	34,5	41,0	50,0
1206042	-4242	42	63,0	40,0	50,0	60,0

## // R1A12MT12M

## Branch Tee union DIN 24° Male - Heavy series

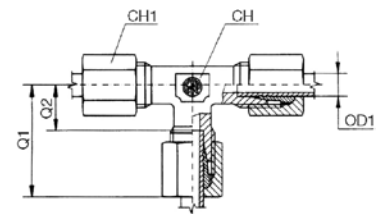

Item Code	Head 1 / Head 2	OD1	Q1	Q2	CH	CH1
	mm	mm	mm	mm	mm	mm
1205716	-0606	6	31,0	16,0	12,0	17,0
1205717	-0808	8	32,0	17,0	14,0	19,0
1205718	-1010	10	34,0	17,5	17,0	22,0
1205719	-1212	12	38,0	21,5	17,0	24,0
1205720	-1414	14	40,0	22,0	19,0	27,0
1205616	-1616	16	43,0	24,5	24,0	30,0
1205721	-2020	20	48,0	26,5	27,0	36,0
1205722	-2525	25	54,0	30,0	36,0	46,0
1205723	-3030	30	62,0	35,5	41,0	50,0
1205724	-3838	38	72,0	41,0	50,0	60,0

**// R1A11MX11M**

**Cross union DIN 24° Male - Light series**

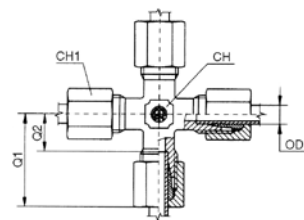

Item Code	Head 1 / Head 2	OD1	Q1	Q2	CH	CH1
	mm	mm	mm	mm	mm	mm
1205725	-0606	6	27,0	12,0	12,0	14,0
1205726	-0808	8	29,0	14,0	12,0	17,0
1205727	-1010	10	30,0	15,0	14,0	19,0
1205755	-1212	12	32,0	17,0	17,0	22,0
1205728	-1515	15	36,0	21,0	19,0	27,0
1205729	-1818	18	40,0	23,5	24,0	32,0
1205730	-2222	22	44,0	27,5	27,0	36,0
1211083	-2828	28	47,0	30,5	36,0	41,0
1211084	-3535	35	56,0	34,5	41,0	50,0
1211085	-4242	42	63,0	40,0	50,0	60,0

**// R1A12MX12M**

**Cross union DIN 24° Male - Heavy series**

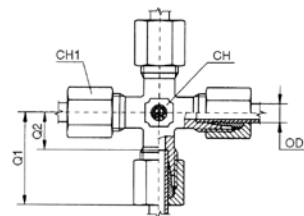

Item Code	Head 1 / Head 2	OD1	Q1	Q2	CH	CH1
	mm	mm	mm	mm	mm	mm
1206376	-0606	6	31,0	16,0	12,0	17,0
1206356	-0808	8	32,0	17,0	14,0	19,0
1206308	-1010	10	34,0	17,5	17,0	22,0
1206128	-1212	12	38,0	21,5	17,0	24,0
1206241	-1414	14	40,0	22,0	19,0	27,0
1206242	-1616	16	43,0	24,5	24,0	30,0
1206570	-2020	20	48,0	26,5	27,0	36,0
1206571	-2525	25	54,0	30,0	36,0	46,0
1208138	-3030	30	62,0	35,5	41,0	50,0
1211263	-3838	38	72,0	41,0	50,0	60,0

Dimensions shown may be changed without prior notice

## // MALE / FEMALE UNION

## // R1A11M1113

## Reducers DIN 24° pre-assembled - Light series

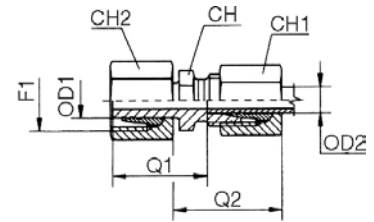

Item Code	Head 1 / Head 2	OD1 mm	OD2 mm	F1	Q1 mm	Q2 mm	CH mm	CH1 mm	CH2 mm
	mm								
1205622	-0806	8	6	M14X1.5	29,5	30,0	14,0	14,0	17,0
1205623	-1006	10	6	M16X1.5	29,5	30,0	14,0	14,0	19,0
1205624	-1008	10	8	M16X1.5	29,5	30,0	17,0	17,0	19,0
1205617	-1206	12	6	M18X1.5	29,5	30,0	14,0	14,0	22,0
1205618	-1208	12	8	M18X1.5	29,5	30,0	17,0	17,0	22,0
1205619	-1210	12	10	M18X1.5	31,0	31,0	17,0	19,0	22,0
1205621	-1506	15	6	M22X1.5	29,5	29,0	17,0	14,0	27,0
1205620	-1508	15	8	M22X1.5	29,5	29,0	17,0	17,0	27,0
1205625	-1510	15	10	M22X1.5	31,0	30,0	17,0	19,0	27,0
1205626	-1512	15	12	M22X1.5	31,0	30,0	19,0	22,0	27,0
1205627	-1806	18	6	M26X1.5	30,5	29,0	19,0	14,0	32,0
1205628	-1808	18	8	M26X1.5	30,5	29,0	19,0	17,0	32,0
1205629	-1810	18	10	M26X1.5	32,0	30,0	19,0	19,0	32,0
1205630	-1812	18	12	M26X1.5	32,0	30,0	19,0	22,0	32,0
1205631	-1815	18	15	M26X1.5	32,5	32,0	24,0	27,0	32,0
1207824	-2206	22	6	M30X2	33,5	32,0	24,0	14,0	36,0
1206843	-2208	22	8	M30X2	33,5	32,0	24,0	17,0	36,0
1206562	-2210	22	10	M30X2	35,0	33,0	24,0	19,0	36,0
1205632	-2212	22	12	M30X2	35,0	33,0	24,0	22,0	36,0
1205633	-2215	22	15	M30X2	35,5	35,0	24,0	27,0	36,0
1205634	-2218	22	18	M30X2	35,0	35,0	27,0	32,0	36,0
1207825	-2806	28	6	M36X2	34,5	33,0	32,0	14,0	41,0
1207826	-2808	28	8	M36X2	34,5	33,0	32,0	17,0	41,0
1207827	-2810	28	10	M36X2	36,0	34,0	32,0	19,0	41,0
1205635	-2812	28	12	M36X2	36,0	34,0	32,0	22,0	41,0
1205636	-2815	28	15	M36X2	36,5	35,0	32,0	27,0	41,0
1205637	-2818	28	18	M36X2	36,0	36,0	32,0	32,0	41,0
1205638	-2822	28	22	M36X2	36,0	38,0	32,0	36,0	41,0
1210999	-3506	35	6	M45X2	40,5	34,0	36,0	14,0	50,0
1211000	-3508	35	8	M45X2	40,5	34,0	36,0	17,0	50,0
1211001	-3510	35	10	M45X2	42,0	35,0	36,0	19,0	50,0
1211002	-3512	35	12	M45X2	42,0	35,0	36,0	22,0	50,0
1211003	-3515	35	15	M45X2	42,5	36,0	36,0	27,0	50,0
1208154	-3518	35	18	M45X2	42,0	37,0	36,0	32,0	50,0
1205639	-3522	35	22	M45X2	44,0	39,0	36,0	36,0	50,0
1205640	-3528	35	28	M45X2	44,0	39,0	41,0	41,0	50,0
1211004	-4210	42	10	M52X2	44,0	36,0	46,0	19,0	60,0
1211005	-4212	42	12	M52X2	43,0	36,0	46,0	22,0	60,0
1211006	-4215	42	15	M52X2	44,5	37,0	46,0	27,0	60,0
1207828	-4218	42	18	M52X2	44,0	38,0	46,0	32,0	60,0
1205641	-4222	42	22	M52X2	46,0	40,0	46,0	36,0	60,0



// R1A12M1123

Reducers DIN 24° pre-assembled - Heavy series

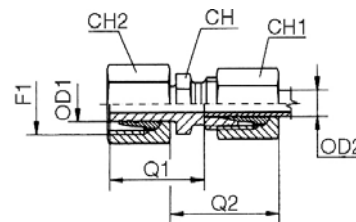

Item Code	Head 1 / Head 2	OD1	OD2	F1	Q1	Q2	CH	CH1	CH2
	mm	mm	mm		mm	mm	mm	mm	mm
1205644	-0806	8	6	M16X1.5	31,0	31,0	17,0	17,0	19,0
1205645	-1006	10	6	M18X1.5	32,0	31,0	17,0	17,0	22,0
1205646	-1008	10	8	M18X1.5	32,0	31,0	17,0	19,0	22,0
1205647	-1206	12	6	M20X1.5	33,0	32,0	17,0	17,0	24,0
1205648	-1208	12	8	M20X1.5	33,0	32,0	17,0	19,0	24,0
1205649	-1210	12	10	M20X1.5	32,5	33,0	19,0	22,0	24,0
1206338	-1406	14	6	M22X1.5	37,0	34,0	17,0	17,0	27,0
1205650	-1408	14	8	M22X1.5	37,0	34,0	17,0	19,0	27,0
1205651	-1410	14	10	M22X1.5	36,5	35,0	19,0	22,0	27,0
1205652	-1412	14	12	M22X1.5	36,5	35,0	22,0	24,0	27,0
1206340	-1606	16	6	M24X1.5	37,0	34,0	17,0	17,0	30,0
1205653	-1608	16	8	M24X1.5	37,0	34,0	17,0	19,0	30,0
1205654	-1610	16	10	M24X1.5	36,5	35,0	19,0	22,0	30,0
1205656	-1614	16	14	M24X1.5	38,0	38,0	24,0	27,0	30,0
1207857	-2006	20	6	M30X2	43,0	36,0	22,0	17,0	36,0
1206362	-2008	20	8	M30X2	43,0	36,0	22,0	19,0	36,0
1205657	-2010	20	10	M30X2	42,5	37,0	22,0	22,0	36,0
1205658	-2012	20	12	M30X2	42,5	37,0	22,0	24,0	36,0
1205659	-2014	20	14	M30X2	44,0	40,0	24,0	27,0	36,0
1205660	-2016	20	16	M30X2	43,5	40,0	27,0	30,0	36,0
1211188	-2506	25	6	M36X2	47,0	38,0	27,0	17,0	46,0
1206884	-2508	25	8	M36X2	47,0	38,0	27,0	19,0	46,0
1205661	-2510	25	10	M36X2	46,5	39,0	27,0	22,0	46,0
1205662	-2512	25	12	M36X2	46,5	39,0	27,0	24,0	46,0
1206339	-2514	25	14	M36X2	48,0	42,0	27,0	27,0	46,0
1205663	-2516	25	16	M36X2	47,5	42,0	27,0	30,0	46,0
1205664	-2520	25	20	M36X2	47,5	45,0	32,0	36,0	46,0
1211189	-3006	30	6	M42X2	49,0	37,0	32,0	17,0	50,0
1211190	-3008	30	8	M42X2	49,0	37,0	32,0	19,0	50,0
1211191	-3010	30	10	M42X2	48,5	38,0	32,0	22,0	50,0
1206563	-3012	30	12	M42X2	48,5	38,0	32,0	24,0	50,0
1206846	-3014	30	14	M42X2	50,0	41,0	32,0	27,0	50,0
1205665	-3016	30	16	M42X2	49,5	41,0	32,0	30,0	50,0
1205666	-3020	30	20	M42X2	49,5	45,0	32,0	36,0	50,0
1205667	-3025	30	25	M42X2	50,0	48,0	41,0	46,0	50,0
1211195	-3814	38	14	M52X2	57,0	42,0	41,0	27,0	60,0
1207858	-3816	38	16	M52X2	56,5	42,0	41,0	30,0	60,0
1205668	-3820	38	20	M52X2	56,5	46,0	41,0	36,0	60,0
1205669	-3825	38	25	M52X2	57,0	49,0	41,0	46,0	60,0

Dimensions shown may be changed without prior notice

## // R1A11M1152

## Reducers DIN 24° with O-Ring - Light series

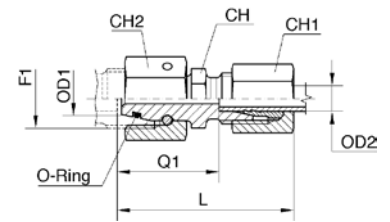

Item Code	Head 1 / Head 2	OD1 mm	OD2 mm	F1	Q1 mm	CH mm	CH1 mm	CH2 mm	L mm
	mm								
1211354	-0806	8	6	M14X1.5	23,5	12,0	14,0	17,0	38,0
1211355	-1006	10	6	M16X1.5	25,0	14,0	14,0	19,0	40,0
1211356	-1008	10	8	M16X1.5	25,0	14,0	17,0	19,0	40,0
1211357	-1206	12	6	M18X1.5	25,0	17,0	14,0	22,0	40,0
1208070	-1208	12	8	M18X1.5	25,0	17,0	17,0	22,0	40,0
1211358	-1210	12	10	M18X1.5	26,0	17,0	19,0	22,0	41,0
1211359	-1506	15	6	M22X1.5	28,5	19,0	14,0	27,0	43,0
1208071	-1508	15	8	M22X1.5	28,5	19,0	17,0	27,0	43,0
1208072	-1510	15	10	M22X1.5	29,5	19,0	19,0	27,0	44,0
1211360	-1512	15	12	M22X1.5	29,5	19,0	22,0	27,0	44,0
1211361	-1806	18	6	M26X1.5	28,0	24,0	14,0	32,0	43,0
1211362	-1808	18	8	M26X1.5	28,0	24,0	17,0	32,0	43,0
1211363	-1810	18	10	M26X1.5	29,0	24,0	19,0	32,0	44,0
1208073	-1812	18	12	M26X1.5	29,0	24,0	22,0	32,0	44,0
1211364	-1815	18	15	M26X1.5	30,0	24,0	27,0	32,0	45,0
1211365	-2206	22	6	M30X2	32,0	27,0	14,0	36,0	47,0
1211366	-2208	22	8	M30X2	32,0	27,0	17,0	36,0	47,0
1211367	-2212	22	12	M30X2	33,0	27,0	22,0	36,0	48,0
1211368	-2215	22	15	M30X2	34,0	27,0	27,0	36,0	49,0
1211369	-2218	22	18	M30X2	33,5	27,0	32,0	36,0	50,0
1211371	-2806	28	6	M36X2	34,0	32,0	14,0	41,0	49,0
1211372	-2808	28	8	M36X2	34,0	32,0	17,0	41,0	49,0
1211373	-2810	28	10	M36X2	35,0	32,0	19,0	41,0	50,0
1211374	-2812	28	12	M36X2	35,0	32,0	22,0	41,0	50,0
1211375	-2815	28	15	M36X2	36,0	32,0	27,0	41,0	51,0
1208082	-2818	28	18	M36X2	36,5	32,0	32,0	41,0	52,0
1211376	-2822	28	22	M36X2	37,5	32,0	36,0	41,0	54,0
1211377	-3515	35	15	M45X2	39,0	41,0	27,0	50,0	54,0
1211378	-3518	35	18	M45X2	38,5	41,0	32,0	50,0	55,0
1208083	-3522	35	22	M45X2	40,5	41,0	36,0	50,0	57,0
1211379	-4218	42	18	M52X2	42,0	50,0	32,0	60,0	58,0
1211380	-4222	42	22	M52X2	44,0	50,0	36,0	60,0	60,0
1211381	-4228	42	28	M52X2	44,0	50,0	41,0	60,0	61,0
1211382	-4235	42	35	M52X2	43,0	50,0	50,0	60,0	65,0

**// R1A12M1162**

**Reducers DIN 24° with O-Ring - Heavy series**

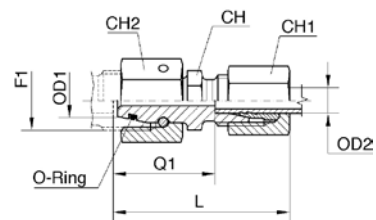

Item Code	Head 1 / Head 2	OD1 mm	OD2 mm	F1	Q1 mm	CH mm	CH1 mm	CH2 mm	L mm
	mm								
1211411	-0806	8	6	M16X1.5	27,0	14,0	17,0	19,0	42,0
1211412	-1006	10	6	M18X1.5	27,5	17,0	17,0	22,0	42,0
1211413	-1008	10	8	M18X1.5	27,5	17,0	19,0	22,0	42,0
1211414	-1206	12	6	M20X1.5	29,0	17,0	17,0	24,0	44,0
1211415	-1208	12	8	M20X1.5	29,0	17,0	19,0	24,0	44,0
1211416	-1210	12	10	M20X1.5	29,5	19,0	22,0	24,0	46,0
1211417	-1406	14	6	M22X1.5	31,5	19,0	17,0	27,0	46,0
1211418	-1408	14	8	M22X1.5	31,5	19,0	19,0	27,0	46,0
1211419	-1410	14	10	M22X1.5	31,0	19,0	22,0	27,0	47,0
1211420	-1412	14	12	M22X1.5	31,0	22,0	24,0	27,0	47,0
1207967	-1606	16	6	M24X1.5	32,0	22,0	17,0	30,0	47,0
1211421	-1608	16	8	M24X1.5	32,0	22,0	19,0	30,0	47,0
1208068	-1610	16	10	M24X1.5	31,5	22,0	22,0	30,0	48,0
1242333	-1612	16	12	M24X1.5	31,5	22,0	24,0	30,0	48,0
1211422	-1614	16	14	M24X1.5	33,0	24,0	27,0	30,0	51,0
1211423	-2006	20	6	M30X2	36,0	27,0	17,0	36,0	51,0
1211424	-2008	20	8	M30X2	36,0	27,0	19,0	36,0	51,0
1211425	-2010	20	10	M30X2	35,5	27,0	22,0	36,0	52,0
1208165	-2012	20	12	M30X2	35,5	27,0	24,0	36,0	52,0
1211426	-2014	20	14	M30X2	37,0	27,0	27,0	36,0	55,0
1208166	-2016	20	16	M30X2	36,5	27,0	30,0	36,0	55,0
1211427	-2506	25	6	M36X2	38,5	32,0	17,0	46,0	53,0
1211428	-2508	25	8	M36X2	38,5	32,0	19,0	46,0	53,0
1211429	-2510	25	10	M36X2	38,0	32,0	22,0	46,0	54,0
1211430	-2512	25	12	M36X2	38,0	32,0	24,0	46,0	54,0
1211431	-2514	25	14	M36X2	39,5	32,0	27,0	46,0	57,0
1208167	-2516	25	16	M36X2	39,0	32,0	30,0	46,0	57,0
1211432	-2520	25	20	M36X2	39,0	32,0	36,0	46,0	61,0
1211433	-3006	30	6	M42X2	44,0	41,0	17,0	50,0	59,0
1211434	-3008	30	8	M42X2	44,0	41,0	19,0	50,0	59,0
1211435	-3010	30	10	M42X2	43,5	41,0	22,0	50,0	60,0
1211436	-3012	30	12	M42X2	43,5	41,0	24,0	50,0	60,0
1211437	-3014	30	14	M42X2	45,0	41,0	27,0	50,0	63,0
1211438	-3016	30	16	M42X2	44,5	41,0	30,0	50,0	63,0
1207987	-3020	30	20	M42X2	44,5	41,0	36,0	50,0	66,0
1207963	-3025	30	25	M42X2	45,0	41,0	46,0	50,0	69,0
1211442	-3814	38	14	M52X2	48,5	50,0	27,0	60,0	66,0
1211443	-3816	38	16	M52X2	48,0	50,0	30,0	60,0	66,0
1211444	-3820	38	20	M52X2	48,0	50,0	36,0	60,0	70,0
1211445	-3825	38	25	M52X2	48,5	50,0	46,0	60,0	73,0
1211446	-3830	38	30	M52X2	49,0	50,0	50,0	60,0	76,0

Dimensions shown may be changed without prior notice

## // R1A11M9113

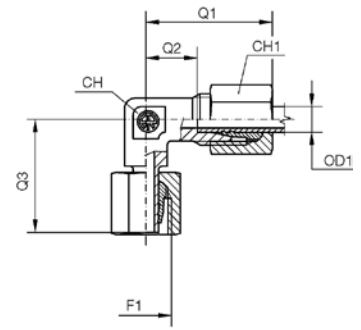
**90° adjustable elbow connector DIN 24° Male - Female pre-assembled - Light series**

Item Code	Head 1 / Head 2	OD1	F1	Q1	Q2	Q3	CH	CH1
	mm							
1206164	-0606	6	M12X1.5	27,0	12,0	26,0	12,0	14,0
1205536	-0808	8	M14X1.5	29,0	14,0	27,5	12,0	17,0
1204070	-1010	10	M16X1.5	30,0	15,0	29,0	14,0	19,0
1242246	-1212	12	M18X1.5	32,0	17,0	29,5	17,0	22,0
1204072	-1515	15	M22X1.5	36,0	21,0	32,5	19,0	27,0
1205756	-1818	18	M26X1.5	40,0	23,5	35,5	24,0	32,0
1205731	-2222	22	M30X2	44,0	27,5	38,5	27,0	36,0
1206045	-2828	28	M36X2	47,0	30,5	41,5	36,0	41,0
1206044	-3535	35	M45X2	56,0	34,5	51,0	41,0	50,0
1205535	-4242	42	M52X2	63,0	40,0	60,0	50,0	60,0

## // R1A12M9123

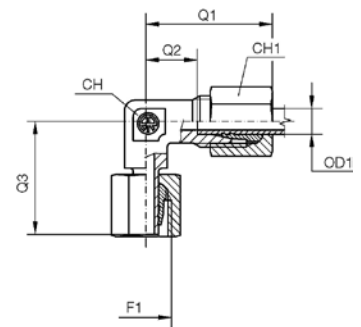
**90° adjustable elbow connector DIN 24° Male - Female pre-assembled - Heavy series**

Item Code	Head 1 / Head 2	OD1	F1	Q1	Q2	Q3	CH	CH1
	mm							
1206278	-0606	6	M14X1.5	31,0	16,0	27,0	12,0	17,0
1205732	-0808	8	M16X1.5	32,0	17,0	27,5	14,0	19,0
1205563	-1010	10	M18X1.5	34,0	17,5	30,0	17,0	22,0
1205757	-1212	12	M20X1.5	38,0	21,5	31,0	17,0	24,0
1205733	-1414	14	M22X1.5	40,0	22,0	35,0	19,0	27,0
1205532	-1616	16	M24X1.5	43,0	24,5	36,5	24,0	30,0
1205533	-2020	20	M30X2	48,0	26,5	44,5	27,0	36,0
1205534	-2525	25	M36X2	54,0	30,0	50,0	36,0	46,0
1205734	-3030	30	M42X2	62,0	35,5	55,0	41,0	50,0
1206412	-3838	38	M52X2	72,0	41,0	64,5	50,0	60,0

**// R1A11M9152**

**90° adjustable elbow connector DIN 24° Male - Female with O-Ring - Light series**

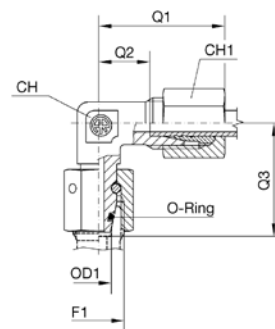

Item Code	Head 1 / Head 2	OD1	F1	Q1	Q2	Q3	CH	CH1
	mm							
1211396	-0606	6	M12X1.5	27,0	12,0	26,0	12,0	14,0
1207070	-0808	8	M14X1.5	29,0	14,0	27,5	12,0	17,0
1206852	-1212	12	M18X1.5	32,0	17,0	29,5	17,0	22,0
1206853	-1515	15	M22X1.5	36,0	21,0	32,5	19,0	27,0
1206854	-1818	18	M26X1.5	40,0	23,5	35,5	24,0	32,0
1206855	-2222	22	M30X2	44,0	27,5	38,5	27,0	36,0
1211397	-2828	28	M36X2	47,0	30,5	41,5	36,0	41,0
1208087	-3535	35	M45X2	56,0	34,5	51,0	41,0	50,0
1211398	-4242	42	M52X2	63,0	40,0	56,0	50,0	60,0

**// R1A12M9162**

**90° adjustable elbow connector DIN 24° Male - Female with O-Ring - Heavy series**

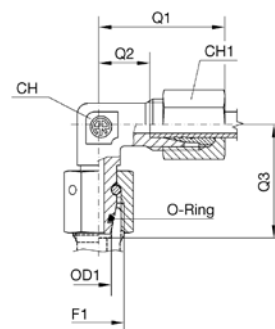

Item Code	Head 1 / Head 2	OD1	F1	Q1	Q2	Q3	CH	CH1
	mm							
1208183	-0606	6	M14X1.5	31,0	16,0	27,0	12,0	17,0
1206824	-0808	8	M16X1.5	32,0	17,0	27,5	14,0	19,0
1211456	-1010	10	M18X1.5	34,0	17,5	30,0	17,0	22,0
1206823	-1212	12	M20X1.5	38,0	21,5	31,0	17,0	24,0
1208186	-1414	14	M22X1.5	40,0	22,0	35,0	19,0	27,0
1207073	-1616	16	M24X1.5	43,0	24,5	36,5	24,0	30,0
1207074	-2020	20	M30X2	48,0	26,5	44,5	27,0	36,0
1241699	-2525	25	M36X2	54,0	30,0	50,0	36,0	46,0
1207076	-3030	30	M42X2	62,0	35,5	55,0	41,0	50,0
1211457	-3838	38	M52X2	72,0	41,0	63,0	50,0	60,0

Dimensions shown may be changed without prior notice

## // R1A11MT113

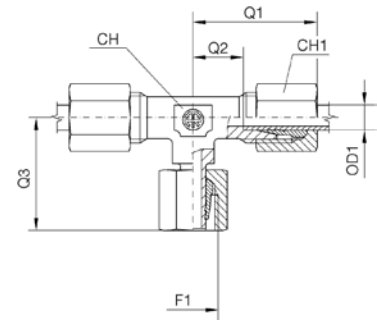
**Branch Tee adjustable elbow connector DIN 24° Male - Female pre-assembled - Light series**

Item Code	Head 1 / Head 2	OD1	F1	Q1	Q2	Q3	CH	CH1
	mm							
1204222	-0606	6	M12X1.5	27,0	12,0	26,0	12,0	14,0
1205477	-0808	8	M14X1.5	29,0	14,0	27,5	12,0	17,0
1205735	-1010	10	M16X1.5	30,0	15,0	29,0	14,0	19,0
1205522	-1212	12	M18X1.5	32,0	17,0	29,5	17,0	22,0
1205676	-1515	15	M22X1.5	36,0	21,0	32,5	19,0	27,0
1205758	-1818	18	M26X1.5	40,0	23,5	35,5	24,0	32,0
1205736	-2222	22	M30X2	44,0	27,5	38,5	27,0	36,0
1206279	-2828	28	M36X2	47,0	30,5	41,5	36,0	41,0
1206584	-3535	35	M45X2	56,0	34,5	51,0	41,0	50,0
1206585	-4242	42	M52X2	63,0	40,0	60,0	50,0	60,0

## // R1A12MT123

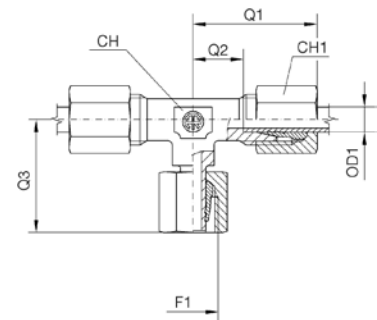
**Branch Tee adjustable elbow connector DIN 24° Male - BSPP Male with O-Ring - Heavy series**

Item Code	Head 1 / Head 2	OD1	F1	Q1	Q2	Q3	CH	CH1
	mm							
1206355	-0606	6	M14X1.5	31,0	16,0	27,0	12,0	17,0
1206373	-0808	8	M16X1.5	32,0	17,0	27,5	14,0	19,0
1205581	-1010	10	M18X1.5	34,0	17,5	30,0	17,0	22,0
1205737	-1212	12	M20X1.5	38,0	21,5	31,0	17,0	24,0
1206280	-1414	14	M22X1.5	40,0	22,0	35,0	19,0	27,0
1205738	-1616	16	M24X1.5	43,0	24,5	36,5	24,0	30,0
1205739	-2020	20	M30X2	48,0	26,5	44,5	27,0	36,0
1206281	-2525	25	M36X2	54,0	30,0	50,0	36,0	46,0
1206297	-3030	30	M42X2	62,0	35,5	55,0	41,0	50,0
1206587	-3838	38	M52X2	72,0	41,0	64,5	50,0	60,0

**// R1A11MT152**

**Branch Tee adjustable elbow connector DIN 24° Male - Female with O-Ring - Light series**

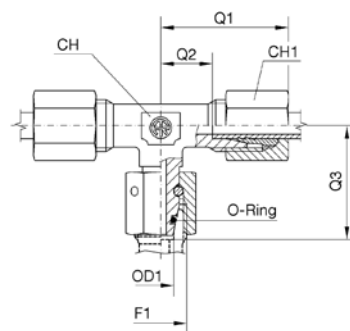

Item Code	Head 1 / Head 2	OD1	F1	Q1	Q2	Q3	CH	CH1
	mm							
1211350	-0606	6	M12X1.5	27,0	12,0	26,0	12,0	14,0
1208058	-0808	8	M14X1.5	29,0	14,0	27,5	12,0	17,0
1206856	-1010	10	M16X1.5	30,0	15,0	29,0	14,0	19,0
1210689	-1212	12	M18X1.5	32,0	17,0	29,5	17,0	22,0
1208059	-1515	15	M22X1.5	36,0	21,0	32,5	19,0	27,0
1208060	-1818	18	M26X1.5	40,0	23,5	35,5	24,0	32,0
1211351	-2222	22	M30X2	44,0	27,5	38,5	27,0	36,0
1211352	-2828	28	M36X2	47,0	30,5	41,5	36,0	41,0
1208061	-3535	35	M45X2	56,0	34,5	51,0	41,0	50,0
1211353	-4242	42	M52X2	63,0	40,0	56,0	50,0	60,0

**// R1A12MT162**

**Branch Tee adjustable elbow connector DIN 24° Male - Female with O-Ring - Heavy series**

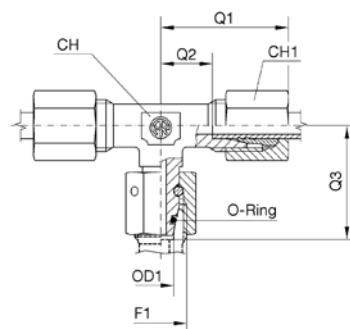

Item Code	Head 1 / Head 2	OD1	F1	Q1	Q2	Q3	CH	CH1
	mm							
1211404	-0606	6	M14X1.5	31,0	16,0	27,0	12,0	17,0
1211405	-0808	8	M16X1.5	32,0	17,0	27,5	14,0	19,0
1208196	-1010	10	M18X1.5	34,0	17,5	30,0	17,0	22,0
1208197	-1212	12	M20X1.5	38,0	21,5	31,0	17,0	24,0
1211406	-1414	14	M22X1.5	40,0	22,0	35,0	19,0	27,0
1207470	-1616	16	M24X1.5	43,0	24,5	36,5	24,0	30,0
1211407	-2020	20	M30X2	48,0	26,5	44,5	27,0	36,0
1211408	-2525	25	M36X2	54,0	30,0	50,0	36,0	46,0
1211409	-3030	30	M42X2	62,0	35,5	55,0	41,0	50,0
1211410	-3838	38	M52X2	72,0	41,0	63,0	50,0	60,0

Dimensions shown may be changed without prior notice

### // R1A11ML113

Run Tee adjustable elbow connector DIN 24° Male - Female pre-assembled - Light series

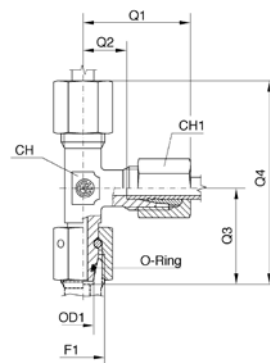

Item Code	Head 1 / Head 2	OD1	F1	Q1	Q2	Q3	CH	CH1
	mm							
1205478	-0606	6	M12X1.5	27,0	12,0	26,0	12,0	14,0
1205479	-0808	8	M14X1.5	29,0	14,0	27,5	12,0	17,0
1205677	-1010	10	M16X1.5	30,0	15,0	29,0	14,0	19,0
1242248	-1212	12	M18X1.5	32,0	17,0	29,5	17,0	22,0
1204221	-1515	15	M22X1.5	36,0	21,0	32,5	19,0	27,0
1205529	-1818	18	M26X1.5	40,0	23,5	35,5	24,0	32,0
1205759	-2222	22	M30X2	44,0	27,5	38,5	27,0	36,0
1206072	-2828	28	M36X2	47,0	30,5	41,5	36,0	41,0
1206129	-3535	35	M45X2	56,0	34,5	51,0	41,0	50,0
1206586	-4242	42	M52X2	63,0	40,0	60,0	50,0	60,0

### // R1A12ML123

Run Tee adjustable elbow connector DIN 24° Male - Female pre-assembled - Heavy series

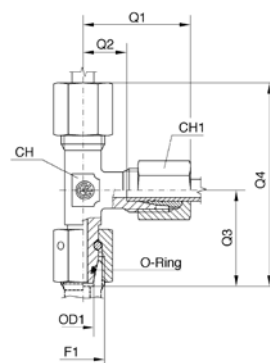

Item Code	Head 1 / Head 2	OD1	F1	Q1	Q2	Q3	CH	CH1
	mm							
1206354	-0606	6	M14X1.5	31,0	16,0	27,0	12,0	17,0
1206367	-0808	8	M16X1.5	32,0	17,0	27,5	14,0	19,0
1205580	-1010	10	M18X1.5	34,0	17,5	30,0	17,0	22,0
1206179	-1212	12	M20X1.5	38,0	21,5	31,0	17,0	24,0
1206130	-1414	14	M22X1.5	40,0	22,0	35,0	19,0	27,0
1206010	-1616	16	M24X1.5	43,0	24,5	36,5	24,0	30,0
1205678	-2020	20	M30X2	48,0	26,5	44,5	27,0	36,0
1206255	-2525	25	M36X2	54,0	30,0	50,0	36,0	46,0
1205574	-3030	30	M42X2	62,0	35,5	55,0	41,0	50,0
1206588	-3838	38	M52X2	72,0	41,0	64,5	50,0	60,0



**// R1A11ML152**

**Run Tee adjustable elbow connector DIN 24° Male - Female with O-Ring - Light series**

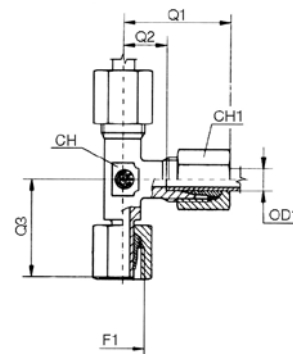

Item Code	Head 1 / Head 2	OD1	F1	Q1	Q2	Q3	CH	CH1
	mm							
1211347	-0606	6	M12X1.5	27,0	12,0	26,0	12,0	14,0
1208088	-0808	8	M14X1.5	29,0	14,0	27,5	12,0	17,0
1206813	-1010	10	M16X1.5	30,0	15,0	29,0	14,0	19,0
1206889	-1212	12	M18X1.5	32,0	17,0	29,5	17,0	22,0
1207522	-1515	15	M22X1.5	36,0	21,0	32,5	19,0	27,0
1208089	-1818	18	M26X1.5	40,0	23,5	35,5	24,0	32,0
1207518	-2222	22	M30X2	44,0	27,5	38,5	27,0	36,0
1208090	-2828	28	M36X2	47,0	30,5	41,5	36,0	41,0
1211348	-3535	35	M45X2	56,0	34,5	51,0	41,0	50,0
1211349	-4242	42	M52X2	63,0	40,0	56,0	50,0	60,0

**// R1A12ML162**

**Run Tee adjustable elbow connector DIN 24° Male - Female with O-Ring - Heavy series**

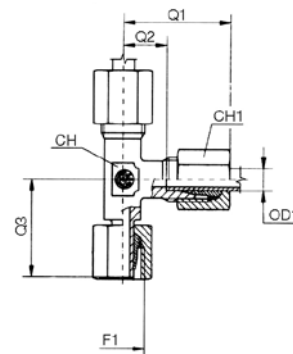

Item Code	Head 1 / Head 2	OD1	F1	Q1	Q2	Q3	CH	CH1
	mm							
1211400	-0606	6	M14X1.5	31,0	16,0	27,0	12,0	17,0
1207087	-0808	8	M16X1.5	32,0	17,0	27,5	14,0	19,0
1211401	-1010	10	M18X1.5	34,0	17,5	30,0	17,0	22,0
1208190	-1212	12	M20X1.5	38,0	21,5	31,0	17,0	24,0
1206883	-1414	14	M22X1.5	40,0	22,0	35,0	19,0	27,0
1211402	-1616	16	M24X1.5	43,0	24,5	36,5	24,0	30,0
1208193	-2020	20	M30X2	48,0	26,5	44,5	27,0	36,0
1207086	-2525	25	M36X2	54,0	30,0	50,0	36,0	46,0
1211403	-3030	30	M42X2	62,0	35,5	55,0	41,0	50,0
1208194	-3838	38	M52X2	72,0	41,0	63,0	50,0	60,0

Dimensions shown may be changed without prior notice

## // BULKHEAD

## // R1A11T111M

## Straight union DIN 24° Bulkhead - Light series

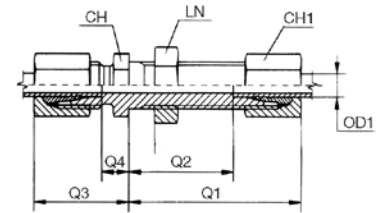

Item Code	Head 1 / Head 2	OD1	F1	Q1	Q2	Q3	Q4	CH	CH1	LN
	mm			mm	mm	mm	mm	mm	mm	mm
1206125	-0606	6	M12X1.5	42,0	27,0	22,0	7,0	17,0	14,0	17,0
1205545	-0808	8	M14X1.5	42,0	27,0	23,0	8,0	19,0	17,0	19,0
1206243	-1010	10	M16X1.5	43,0	28,0	25,0	10,0	22,0	19,0	22,0
1205892	-1212	12	M18X1.5	44,0	29,0	25,0	10,0	24,0	22,0	24,0
1205679	-1515	15	M22X1.5	46,0	31,0	27,0	12,0	27,0	27,0	30,0
1206126	-1818	18	M26X1.5	49,0	32,5	30,0	13,5	32,0	32,0	36,0
1205540	-2222	22	M30X2	51,0	34,5	33,0	16,5	36,0	36,0	41,0
1206071	-2828	28	M36X2	52,0	35,5	35,0	18,5	41,0	41,0	46,0
1206244	-3535	35	M45X2	58,0	36,5	40,0	18,5	50,0	50,0	55,0
1207043	-4242	42	M52X2	59,0	36,0	42,0	19,0	60,0	60,0	65,0

## // R1A12T112M

## Straight union DIN 24° Bulkhead - Heavy series

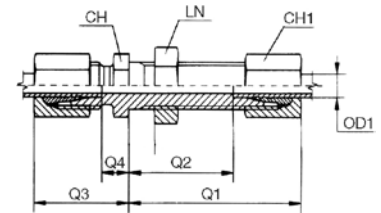

Item Code	Head 1 / Head 2	OD1	F1	Q1	Q2	Q3	Q4	CH	CH1	LN
	mm			mm	mm	mm	mm	mm	mm	mm
1206358	-0606	6	M14X1.5	44,0	29,0	27,0	12,0	19,0	17,0	19,0
1205969	-0808	8	M16X1.5	44,0	29,0	28,0	13,0	22,0	19,0	22,0
1206245	-1010	10	M18X1.5	46,0	29,5	31,0	14,5	24,0	22,0	24,0
1206247	-1212	12	M20X1.5	47,0	30,5	31,0	14,5	27,0	24,0	27,0
1206246	-1414	14	M22X1.5	50,0	32,0	35,0	17,0	30,0	27,0	30,0
1205970	-1616	16	M24X1.5	50,0	31,5	35,0	16,5	32,0	30,0	32,0
1205957	-2020	20	M30X2	55,0	33,5	39,0	17,5	41,0	36,0	41,0
1206127	-2525	25	M36X2	59,0	35,0	44,0	20,0	46,0	46,0	46,0
1205575	-3030	30	M42X2	64,0	37,5	48,0	21,5	50,0	50,0	50,0
1206417	-3838	38	M52X2	68,0	37,0	53,0	22,0	65,0	60,0	65,0

**// R1A11T911M**

**90° union DIN 24° Bulkhead - Light series**

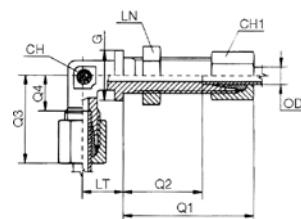

Item Code	Head 1 / Head 2	OD1	F1	Q1	Q2	Q3	Q4	LT	CH	CH1	LN
	mm			mm	mm	mm	mm				
1206248	-0606	6	M12X1.5	42,0	27,0	27,0	12,0	14,0	12,0	14,0	17,0
1206249	-0808	8	M14X1.5	42,0	27,0	29,0	14,0	17,0	12,0	17,0	19,0
1206250	-1010	10	M16X1.5	43,0	28,0	30,0	15,0	18,0	14,0	19,0	22,0
1206251	-1212	12	M18X1.5	44,0	29,0	32,0	17,0	20,0	17,0	22,0	24,0
1205686	-1515	15	M22X1.5	46,0	31,0	36,0	21,0	23,0	19,0	27,0	30,0
1206252	-1818	18	M26X1.5	49,0	32,5	40,0	23,5	24,0	24,0	32,0	36,0
1206253	-2222	22	M30X2	51,0	34,5	44,0	27,5	30,0	27,0	36,0	41,0
1206357	-2828	28	M36X2	52,0	35,5	47,0	30,5	34,0	36,0	41,0	46,0
1206254	-3535	35	M45X2	58,0	36,5	56,0	34,5	39,0	41,0	50,0	55,0
1206820	-4242	42	M52X2	59,0	36,0	63,0	40,0	43,0	50,0	60,0	65,0

**// R1A12T912M**

**90° union DIN 24° Bulkhead - Heavy series**

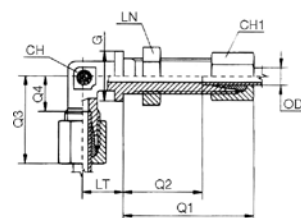

Item Code	Head 1 / Head 2	OD1	F1	Q1	Q2	Q3	Q4	LT	CH	CH1	LN
	mm			mm	mm	mm	mm				
1207147	-0606	6	M14X1.5	44,0	29,0	31,0	16,0	17,0	12,0	17,0	19,0
1206374	-0808	8	M16X1.5	44,0	29,0	32,0	17,0	18,0	14,0	19,0	22,0
1206256	-1010	10	M18X1.5	46,0	29,5	34,0	17,5	20,0	17,0	22,0	24,0
1206260	-1212	12	M20X1.5	47,0	30,5	38,0	21,5	21,0	17,0	24,0	27,0
1206257	-1414	14	M22X1.5	50,0	32,0	40,0	22,0	23,0	19,0	27,0	30,0
1206258	-1616	16	M24X1.5	50,0	31,5	43,0	24,5	24,0	24,0	30,0	32,0
1206259	-2020	20	M30X2	55,0	33,5	48,0	26,5	30,0	27,0	36,0	41,0
1206261	-2525	25	M36X2	59,0	35,0	54,0	30,0	34,0	36,0	46,0	46,0
1207148	-3030	30	M42X2	64,0	37,5	62,0	35,5	39,0	41,0	50,0	50,0
1207149	-3838	38	M52X2	68,0	37,0	72,0	41,0	43,0	50,0	60,0	65,0

Dimensions shown may be changed without prior notice

## // METRIC

## // R1A11M150M

Straight connector DIN 24° Male - Metric cylindric - Light series

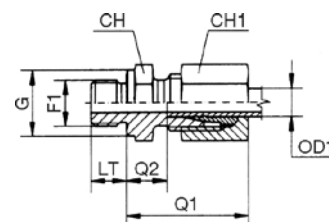

Item Code	Head 1 / Head 2	OD1	F1	Q1	Q2	CH	CH1	LT	G
	mm								
1205809	-0610	6	M10X1.0	23,0	8,5	14,0	14,0	8,0	14,0
1205684	-0812	8	M12X1.5	25,0	10,0	17,0	17,0	12,0	17,0
1205556	-1014	10	M14X1.5	26,0	11,0	19,0	19,0	12,0	19,0
1203520	-1216	12	M16X1.5	27,0	12,5	22,0	22,0	12,0	21,0
1205557	-1518	15	M18X1.5	29,0	14,0	24,0	27,0	14,0	23,0
1206006	-1822	18	M22X1.5	31,0	14,5	27,0	32,0	14,0	27,0
1205812	-2226	22	M26X1.5	33,0	16,5	32,0	36,0	16,0	31,0
1206534	-2833	28	M33X2.0	34,0	17,5	41,0	41,0	18,0	39,0
1208162	-3542	35	M42X2	39,0	17,5	50,0	50,0	20,0	49,0
1207814	-4248	42	M48X2.0	42,0	19,0	55,0	60,0	22,0	55,0

## // R1A12M150M

Straight connector DIN 24° Male - Metric cylindric - Heavy series

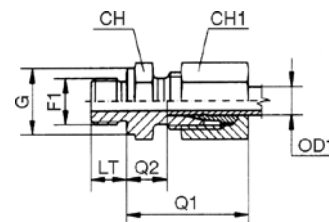

Item Code	Head 1 / Head 2	OD1	F1	Q1	Q2	CH	CH1	LT	G
	mm								
1206225	-0612	6	M12X1.5	28,0	13,0	17,0	17,0	12,0	17,0
1206226	-0814	8	M14X1.5	30,0	15,0	19,0	19,0	12,0	19,0
1205971	-1016	10	M16X1.5	31,0	15,0	22,0	22,0	12,0	21,0
1205813	-1218	12	M18X1.5	33,0	17,0	24,0	24,0	12,0	23,0
1205814	-1420	14	M20X1.5	37,0	19,0	27,0	27,0	14,0	25,0
1205815	-1622	16	M22X1.5	37,0	18,5	27,0	30,0	14,0	27,0
1205816	-2027	20	M27X2	42,0	20,5	32,0	36,0	16,0	32,0
1205817	-2533	25	M33X2.0	47,0	23,0	41,0	46,0	18,0	39,0
1211293	-3042	30	M42X2	50,0	23,5	50,0	50,0	20,0	49,0
1211294	-3848	38	M48X2.0	57,0	26,0	55,0	60,0	22,0	55,0

**// R1A11M950M**

**90° elbow connector DIN 24° Male - Metric cylindric - Light series**

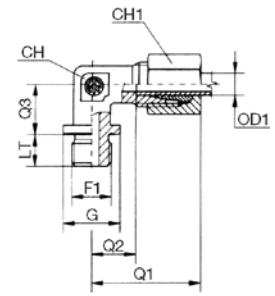

Item Code	Head 1 / Head 2	OD1	F1	Q1	Q2	Q3	CH	CH1	LT	G
	mm									
1211163	-2226	22	M26X1.5	44,0	27,5	26,0	27,0	36,0	16,0	31,0
1211164	-2833	28	M33X2.0	47,0	30,5	30,0	36,0	41,0	18,0	39,0
1211165	-3542	35	M42X2	56,0	34,5	34,0	41,0	50,0	20,0	49,0
1211166	-4248	42	M48X2.0	63,0	40,0	39,0	50,0	60,0	22,0	55,0

**// R1A12M950M**

**90° elbow connector DIN 24° Male - Metric cylindric - Heavy series**

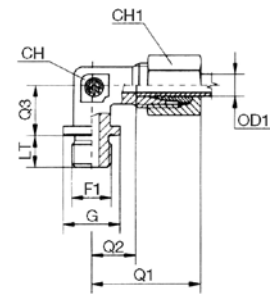

Item Code	Head 1 / Head 2	OD1	F1	Q1	Q2	Q3	CH	CH1	LT	G
	mm									
1211320	-2027	20	M27X2	48,0	26,5	26,0	27,0	36,0	16,0	32,0
1211321	-2533	25	M33X2.0	54,0	31,0	30,0	36,0	46,0	18,0	39,0
1211322	-3042	30	M42X2	62,0	35,5	34,0	41,0	50,0	20,0	49,0
1211323	-3848	38	M48X2.0	72,0	41,0	39,0	50,0	60,0	22,0	55,0

**// R1A11M952Q**

**90° adjustable elbow connector DIN 24° Male - Metric Male with O-Ring and retaining ring - Light series**

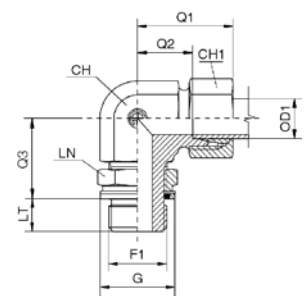

Item Code	Head 1 / Head 2	OD1	F1	Q1	Q2	Q3	CH	CH1	LN	LT	G
	mm										
1242471	-0610	6	M10X1.0	29,0	14,0	20,0	14,0	14,0	14,0	7,5	15,0
1231361	-0812	8	M12X1.5	31,0	16,0	22,5	14,0	17,0	17,0	9,5	18,0
1231362	-1014	10	M14X1.5	32,0	17,0	25,5	19,0	19,0	19,0	9,5	20,0
1242472	-1216	12	M16X1.5	34,0	19,0	26,0	19,0	22,0	22,0	10,0	23,0
1231363	-1518	15	M18X1.5	36,0	21,0	30,0	22,0	27,0	24,0	11,0	25,0
1242473	-1822	18	M22X1.5	40,0	24,0	34,0	27,0	32,0	27,0	11,0	28,0
1237041	-2227	22	M27X2	44,0	28,0	36,0	33,0	36,0	32,0	13,5	33,0
1231364	-2833	28	M33X2.0	47,0	31,0	40,5	41,0	41,0	41,0	13,5	41,0
1231365	-3542	35	M42X2	59,0	38,0	48,5	48,0	50,0	50,0	13,5	51,0
1242474	-4248	42	M48X2.0	61,0	38,0	50,0	48,0	60,0	55,0	15,0	56,0

Dimensions shown may be changed without prior notice

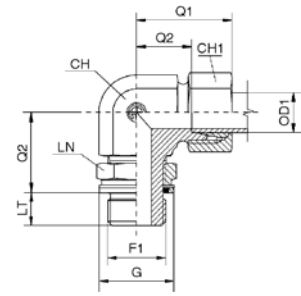
**// R1A12M952Q****90° adjustable elbow connector DIN 24° Male - Metric Male with O-Ring and retaining ring - Heavy series**

Item Code	Head 1 / Head 2	OD1	F1	Q1	Q2	Q3	CH	CH1	LN	LT	G
	mm			mm	mm	mm	mm	mm	mm	mm	
1216243	-0814	8	M14X1.5	33,0	18,0	26,5	19,0	19,0	19,0	9,5	20,0
1242475	-1016	12	M16X1.5	34,0	18,0	27,0	19,0	22,0	22,0	11,0	23,0
1242476	-1218	12	M18X1.5	38,0	22,0	30,5	22,0	24,0	24,0	12,5	25,0
1242477	-1622	16	M22X1.5	43,0	25,0	37,0	27,0	30,0	27,0	13,0	28,0
1211329	-2027	20	M27X2	49,0	28,0	39,5	33,0	36,0	32,0	14,0	33,0
1242478	-2533	25	M33X2.0	54,5	30,5	43,0	41,0	46,0	41,0	14,0	41,0
1242479	-3042	30	M42X2	62,0	36,0	52,0	48,0	50,0	50,0	16,0	51,0
1242480	-3848	38	M48X2.0	65,0	34,0	51,0	48,0	60,0	55,0	18,0	56,0

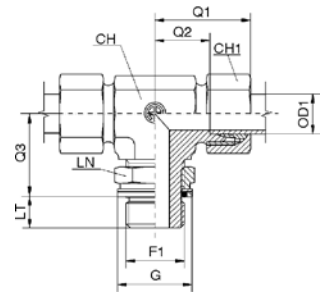
**// R1A11MT52Q****Branch Tee adjustable elbow connector DIN 24° Male - Metric Male with O-Ring and retaining ring - Light series**

Item Code	Head 1 / Head 2	OD1	F1	Q1	Q2	Q3	CH	CH1	LN	LT	G
	mm			mm	mm	mm	mm	mm	mm	mm	
1242481	-0610	6	M10X1.0	29,0	14,0	20,0	14,0	14,0	14,0	7,5	15,0
1242482	-0812	8	M12X1.5	31,0	16,0	22,5	14,0	17,0	17,0	9,5	18,0
1242483	-1014	10	M14X1.5	32,0	17,0	25,5	19,0	19,0	19,0	9,5	20,0
1242484	-1216	12	M16X1.5	34,0	19,0	26,0	19,0	22,0	22,0	10,0	23,0
1242485	-1518	15	M18X1.5	36,0	21,0	30,0	22,0	27,0	24,0	11,0	25,0
1242486	-1822	18	M22X1.5	40,0	24,0	34,0	27,0	32,0	27,0	11,0	28,0
1242487	-2227	22	M27X2	44,0	28,0	36,0	33,0	36,0	32,0	13,5	33,0
1242488	-2833	28	M33X2.0	47,0	31,0	40,5	41,0	41,0	41,0	13,5	41,0
1242489	-3542	35	M42X2	59,0	38,0	48,5	48,0	50,0	50,0	13,5	51,0
1237043	-4248	42	M48X2.0	61,0	38,0	50,0	48,0	60,0	55,0	15,0	56,0

### // R1A12MT52Q

Branch Tee adjustable elbow connector DIN 24° Male - Metric Male with O-Ring and retaining ring - Heavy series

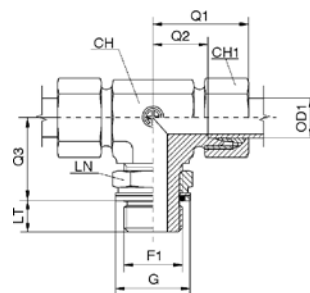

Item Code	Head 1 / Head 2	OD1	F1	Q1	Q2	Q3	CH	CH1	LN	LT	G
	mm										
1242490	-0612	8	M12X1.5	30,5	15,5	23,5	14,0	17,0	17,0	9,5	18,0
1242491	-0814	8	M14X1.5	33,0	18,0	26,5	19,0	19,0	19,0	9,5	20,0
1242492	-1016	10	M16X1.5	34,0	18,0	27,0	19,0	22,0	22,0	11,0	23,0
1242493	-1218	12	M18X1.5	38,0	22,0	30,5	22,0	24,0	24,0	12,5	25,0
1242494	-1622	16	M22X1.5	43,0	25,0	37,0	27,0	30,0	27,0	13,0	28,0
1242495	-2027	20	M27X2	49,0	28,0	39,5	33,0	36,0	32,0	14,0	33,0
1242496	-2533	25	M33X2.0	54,5	30,5	43,0	41,0	46,0	41,0	14,0	41,0
1242497	-3042	30	M42X2	62,0	36,0	52,0	48,0	50,0	50,0	16,0	51,0
1242498	-3848	38	M48X2.0	65,0	34,0	51,0	48,0	60,0	55,0	18,0	56,0

### // R1A11ML52Q

Run Tee adjustable elbow connector DIN 24° Male - Metric Male with O-Ring and retaining ring - Light series

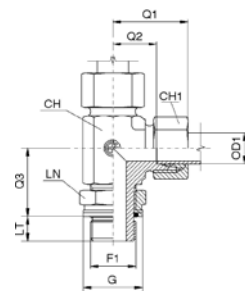

Item Code	Head 1 / Head 2	OD1	F1	Q1	Q2	Q3	CH	CH1	LN	LT	G
	mm										
1242499	-0610	-	M10X1.0	29,0	14,0	20,0	14,0	14,0	14,0	7,5	15,0
1242500	-0812	8	M12X1.5	31,0	16,0	22,5	14,0	17,0	17,0	9,5	18,0
1242501	-1014	10	M14X1.5	32,0	17,0	25,5	19,0	19,0	19,0	9,5	20,0
1242502	-1216	12	M16X1.5	34,0	19,0	26,0	19,0	22,0	22,0	10,0	23,0
1242503	-1518	15	M18X1.5	36,0	21,0	30,0	22,0	27,0	24,0	11,0	25,0
1242504	-1822	18	M22X1.5	40,0	24,0	34,0	27,0	32,0	27,0	11,0	28,0
1242505	-2227	22	M27X2	44,0	28,0	36,0	33,0	36,0	32,0	13,5	33,0
1242506	-2833	28	M33X2.0	47,0	31,0	40,5	41,0	41,0	41,0	13,5	41,0
1242507	-3542	35	M42X2	59,0	38,0	48,5	48,0	50,0	50,0	13,5	51,0
1242508	-4248	42	M48X2.0	61,0	38,0	50,0	48,0	60,0	55,0	15,0	56,0

Dimensions shown may be changed without prior notice

## // R1A12ML52Q

Run Tee adjustable elbow connector DIN 24° Male - Metric Male  
with O-Ring and retaining ring - Heavy series

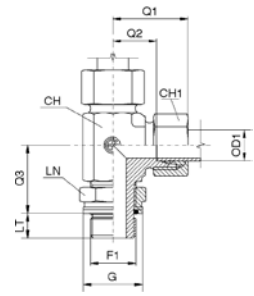

Item Code	Head 1 / Head 2	OD1	F1	Q1	Q2	Q3	CH	CH1	LN	LT	G
	mm			mm	mm	mm	mm	mm	mm	mm	
1242509	-0612	8	M12X1.5	30,5	15,5	23,5	14,0	17,0	17,0	9,5	18,0
1242510	-0814	8	M14X1.5	33,0	18,0	26,5	19,0	19,0	19,0	9,5	20,0
1242511	-1016	10	M16X1.5	34,0	18,0	27,0	19,0	22,0	22,0	11,0	23,0
1242512	-1218	12	M18X1.5	38,0	22,0	30,5	22,0	24,0	24,0	12,5	25,0
1242513	-1622	16	M22X1.5	43,0	25,0	37,0	27,0	30,0	27,0	13,0	28,0
1242514	-2027	20	M27X2	49,0	28,0	39,5	33,0	36,0	32,0	14,0	33,0
1242515	-2533	25	M33X2.0	54,5	30,5	43,0	41,0	46,0	41,0	14,0	41,0
1242516	-3042	30	M42X2	62,0	36,0	52,0	48,0	50,0	50,0	16,0	51,0
1242517	-3848	38	M48X2.0	65,0	34,0	51,0	48,0	60,0	55,0	18,0	56,0

## // R1A11M152I

Straight connector DIN 24° Male - Metric cylindric with  
elastomer - Light series

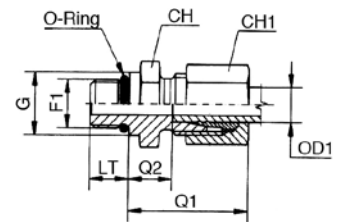

Item Code	Head 1 / Head 2	OD1	F1	Q1	Q2	CH	CH1	LT	G
	mm			mm	mm	mm	mm	mm	mm
1206135	-0610	6	M10X1.0	23,0	8,5	14,0	14,0	8,0	14,0
1206136	-0812	8	M12X1.5	25,0	10,0	17,0	17,0	12,0	17,0
1206137	-1014	10	M14X1.5	26,0	11,0	19,0	19,0	12,0	19,0
1206163	-1216	12	M16X1.5	27,0	12,5	22,0	22,0	12,0	22,0
1206138	-1518	15	M18X1.5	29,0	14,0	24,0	27,0	14,0	24,0
1206085	-1822	18	M22X1.5	31,0	14,5	27,0	32,0	14,0	27,0
1206284	-2226	22	M26X1.5	33,0	16,5	32,0	36,0	16,0	32,0
1207004	-2833	28	M33X2.0	34,0	17,5	41,0	41,0	18,0	40,0
1207005	-3542	35	M42X2	39,0	17,5	50,0	50,0	20,0	50,0



**// R1A12M152I**

**Straight connector DIN 24° Male - Metric cylindric with elastomer - Heavy series**

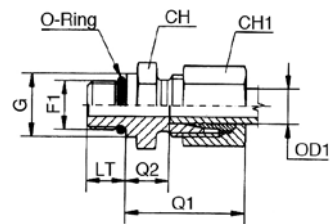

Item Code	Head 1 / Head 2	OD1	F1	Q1	Q2	CH	CH1	LT	G
	mm								
1206285	-0612	6	M12X1.5	28,0	13,0	17,0	17,0	12,0	17,0
1207024	-0814	8	M14X1.5	30,0	15,0	19,0	19,0	12,0	19,0
1206286	-1016	10	M16X1.5	31,0	15,0	22,0	22,0	12,0	22,0
1206162	-1218	12	M18X1.5	33,0	17,0	24,0	24,0	12,0	24,0
1211295	-1420	14	M20X1.5	37,0	19,0	27,0	27,0	14,0	26,0
1206287	-1622	16	M22X1.5	37,0	18,5	27,0	30,0	14,0	27,0
1241127	-2027	20	M27X2	42,0	20,5	32,0	36,0	16,0	32,0
1206061	-2533	25	M33X2.0	47,0	23,0	41,0	46,0	18,0	40,0
1211296	-3042	30	M42X2	50,0	23,5	50,0	50,0	20,0	50,0
1208081	-3848	38	M48X2.0	57,0	26,0	55,0	60,0	22,0	55,0

**// R1A113152I**

**Straight connector DIN 24° Female pre-assembled - Metric cylindric with elastomer - Light series**

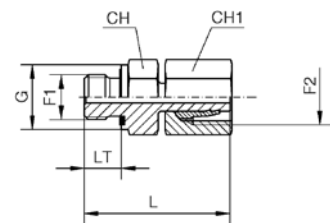

Item Code	Head 1 / Head 2	OD1	F1	F2	LT	CH	CH1	G	L
	mm								
1206979	-0610	6	M12X1.5	M10X1.0	8,0	14,0	14,0	14,0	32,5
1206980	-0812	8	M14X1.5	M12X1.5	12,0	17,0	17,0	17,0	38,5
1206981	-1014	10	M16X1.5	M14X1.5	12,0	19,0	19,0	19,0	39,0
1206288	-1216	12	M18X1.5	M16X1.5	12,0	22,0	22,0	22,0	42,5
1206067	-1518	15	M22X1.5	M18X1.5	12,0	24,0	27,0	24,0	43,5
1206982	-1822	18	M26X1.5	M22X1.5	14,0	27,0	32,0	27,0	45,5
1206983	-2226	22	M30X2	M26X1.5	16,0	32,0	36,0	32,0	48,5
1206984	-2833	28	M36X2	M33X2.0	18,0	41,0	41,0	40,0	53,5
1206985	-3542	35	M45X2	M42X2	20,0	50,0	50,0	50,0	62,5
1206986	-4248	42	M52X2	M48X2.0	22,0	55,0	60,0	55,0	68,5

Dimensions shown may be changed without prior notice

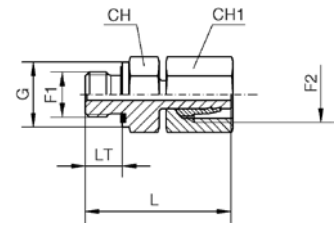
**// R1A123152I****Straight connector DIN 24° Female pre-assembled - Metric cylindric with elastomer - Heavy series**

Item Code	Head 1 / Head 2	OD1	F1	F2	LT	CH	CH1	G	L
	mm								
1207011	-0612	6	M14X1.5	M12X1.5	12,0	17,0	17,0	17,0	39,0
1207012	-0814	8	M16X1.5	M14X1.5	12,0	19,0	19,0	19,0	41,5
1207013	-1016	10	M18X1.5	M16X1.5	12,0	22,0	22,0	22,0	44,0
1207014	-1218	12	M20X1.5	M18X1.5	12,0	24,0	24,0	24,0	46,0
1207015	-1420	14	M22X1.5	M20X1.5	14,0	27,0	27,0	26,0	50,5
1207016	-1622	16	M24X1.5	M22X1.5	14,0	27,0	30,0	27,0	51,0
1207017	-2027	20	M30X2	M27X2	16,0	32,0	36,0	32,0	59,0
1207018	-2533	25	M36X2	M33X2.0	18,0	41,0	46,0	40,0	66,0
1207019	-3042	30	M42X2	M42X2	20,0	50,0	50,0	50,0	71,0
1207020	-3848	38	M52X2	M48X2.0	22,0	55,0	60,0	55,0	82,0

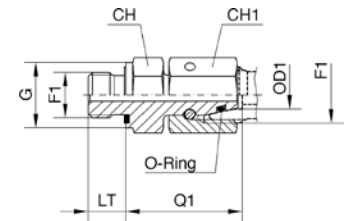
**// R1A152152I****Straight connector DIN 24° Female with O-Ring - Metric cylindric with elastomer - Light series**

Item Code	Head 1 / Head 2	OD1	F1	F2	Q1	LT	CH	CH1	G
	mm								
1211387	-0610	6	M12X1.5	M10X1.0	24,5	8,0	14,0	14,0	14,0
1211388	-0812	8	M14X1.5	M12X1.5	26,5	12,0	17,0	17,0	17,0
1211389	-1014	10	M16X1.5	M14X1.5	27,5	12,0	19,0	19,0	19,0
1211390	-1216	12	M18X1.5	M16X1.5	30,5	12,0	22,0	22,0	22,0
1211391	-1518	15	M22X1.5	M18X1.5	31,5	12,0	24,0	27,0	24,0
1208086	-1822	18	M26X1.5	M22X1.5	31,5	14,0	27,0	32,0	27,0
1211392	-2226	22	M30X2	M26X1.5	32,5	16,0	32,0	36,0	32,0
1211393	-2833	28	M36X2	M33X2.0	35,0	18,0	41,0	41,0	40,0
1211394	-3542	35	M45X2	M42X2	42,5	20,0	50,0	50,0	50,0
1211395	-4248	42	M52X2	M48X2.0	46,5	22,0	55,0	60,0	55,0

**// R1A162152I**

**Straight connector DIN 24° Female with O-Ring - Metric cylindrical with elastomer - Heavy series**

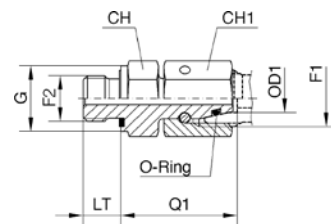

Item Code	Head 1 / Head 2	OD1	F1	F2	Q1	LT	CH	CH1	G
	mm								
1211450	-0612	6	M14X1.5	M12X1.5	27,0	12,0	17,0	17,0	17,0
1211451	-0814	8	M16X1.5	M14X1.5	29,5	12,0	19,0	19,0	19,0
1211452	-1016	10	M18X1.5	M16X1.5	32,0	12,0	22,0	22,0	22,0
1208171	-1218	12	M20X1.5	M18X1.5	34,0	12,0	24,0	24,0	24,0
1208172	-1420	14	M22X1.5	M20X1.5	36,5	14,0	27,0	27,0	26,0
1211453	-1622	16	M24X1.5	M22X1.5	37,0	14,0	27,0	30,0	27,0
1211454	-2027	20	M30X2	M27X2	43,0	16,0	32,0	36,0	32,0
1211455	-2533	25	M36X2	M33X2.0	48,0	18,0	41,0	46,0	40,0
1208178	-3042	30	M42X2	M42X2	51,0	20,0	50,0	50,0	50,0
1208181	-3848	38	M52X2	M48X2.0	60,0	22,0	55,0	60,0	55,0

**// R1A11M962M**

**90° elbow connector DIN 24° Male - Metric conic - Light series**

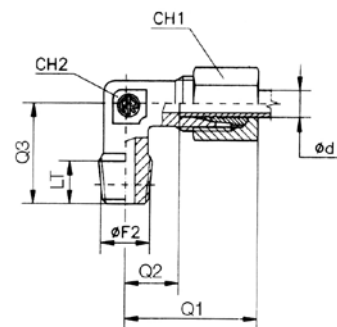

Item Code	Head 1 / Head 2	OD1	F2	Q1	Q2	Q3	CH	CH1	LT
	mm								
1206141	-0610	6	M10X1.0	27,0	12,0	20,0	12,0	14,0	8,0
1206353	-0812	8	M12X1.5	29,0	14,0	26,0	12,0	17,0	12,0
1205818	-1014	10	M14X1.5	30,0	15,0	27,0	14,0	19,0	12,0
1205819	-1216	12	M16X1.5	32,0	17,0	28,0	17,0	22,0	12,0
1206229	-1518	15	M18X1.5	36,0	21,0	34,0	19,0	27,0	14,0
1208106	-1822	18	M22X1.5	40,0	23,5	36,0	24,0	32,0	14,0

Dimensions shown may be changed without prior notice

**// R1A12M962M**

**90° elbow connector DIN 24° Male - Metric conic - Heavy series**

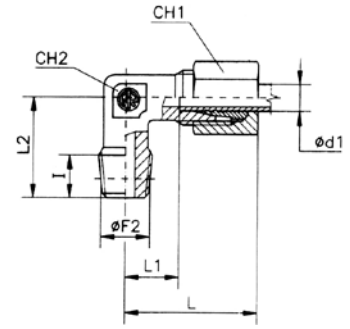

Item Code	Head 1 / Head 2	OD1	F2	Q1	Q2	Q3	CH	CH1	LT
	mm			mm	mm	mm	mm	mm	
1211333	-0612	6	M12X1.5	31,0	16,0	26,0	12,0	17,0	12,0
1211334	-0814	8	M14X1.5	32,0	17,0	27,0	14,0	19,0	12,0
1206142	-1016	10	M16X1.5	34,0	17,5	28,0	17,0	22,0	12,0
1206143	-1218	12	M18X1.5	38,0	21,5	31,0	17,0	24,0	12,0
1211335	-1420	14	M20X1.5	40,0	22,0	32,0	19,0	27,0	14,0
1206720	-1622	16	M22X1.5	43,0	24,5	32,0	24,0	30,0	14,0

**// R1A11M909M**

**Banjo adjustable - Type A - Metric cylindric DIN 24° - Light series**

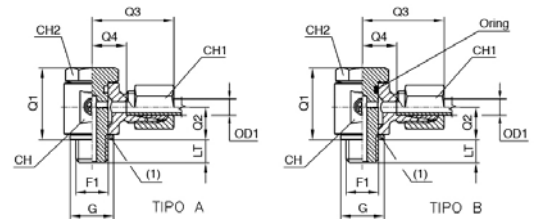

Item Code	Head 1 / Head 2	OD1	F1	Q1	Q2	Q3	Q4	LT	CH	CH1	CH2	G
	mm			mm	mm	mm	mm		mm	mm	mm	
1205882	-0610	6	M10X1.0	27,0	12,5	29,0	13,0	8,0	19,0	14,0	17,0	15,0
1206274	-0812	8	M12X1.5	30,5	15,0	30,5	14,5	12,0	22,0	17,0	19,0	17,0
1231370	-1014	10	M14X1.5	30,5	15,0	32,0	15,5	12,0	22,0	19,0	19,0	18,0
1206581	-1216	12	M16X1.5	38,5	19,0	36,0	19,5	12,0	30,0	22,0	24,0	22,0
1206577	-1518	15	M18X1.5	44,5	21,5	39,0	22,5	14,0	36,0	27,0	24,0	22,0
1206580	-1822	18	M22X1.5	48,0	23,0	40,0	22,0	14,0	36,0	32,0	27,0	26,0
1206579	-2226	22	M26X1.5	56,0	26,0	47,0	28,0	16,0	41,0	36,0	32,0	32,0

**// R1A12M909M**

**Banjo adjustable - Type A - Metric cylindric DIN 24° - Heavy series**

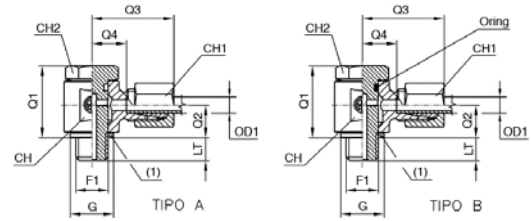

Item Code	Head 1 / Head 2	OD1	F1	Q1	Q2	Q3	Q4	LT	CH	CH1	CH2	G
	mm			mm	mm	mm	mm		mm	mm	mm	
1207056	-0612	6	M12X1.5	30,5	15,0	33,0	16,5	12,0	22,0	17,0	19,0	17,0
1207057	-0814	8	M14X1.5	30,5	15,0	32,5	16,5	12,0	22,0	19,0	19,0	18,0
1208098	-1016	10	M16X1.5	38,5	19,0	38,0	20,0	12,0	30,0	22,0	24,0	22,0
1206456	-1218	12	M18X1.5	37,5	18,0	38,0	20,0	12,0	30,0	24,0	24,0	22,0
1208099	-1420	14	M20X1.5	48,0	23,0	42,5	23,5	14,0	36,0	27,0	27,0	26,0
1206578	-1622	16	M22X1.5	48,0	23,0	43,0	23,0	14,0	36,0	30,0	27,0	26,0
1211301	-2027	20	M27X2	56,0	26,0	51,5	27,0	16,0	41,0	36,0	32,0	32,0

**// R1A11ME50M**

**Banjo adjustable - Type B - Metric cylindric DIN 24° - Light series**

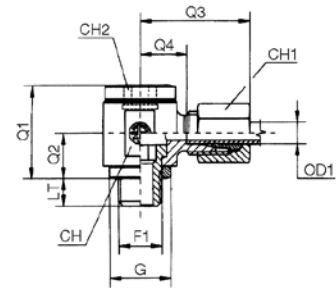

Item Code	Head 1 / Head 2	OD1	F1	Q1	Q2	Q3	Q4	LT	CH	CH1	CH2	G
	mm			mm	mm	mm	mm		mm	mm	mm	
1211010	-0610	6	M10X1.0	24,0	12,0	27,0	12,5	8,0	19,0	14,0	6,0	14,0
1206153	-0812	8	M12X1.5	30,0	15,0	29,0	14,5	12,0	22,0	17,0	6,0	17,0
1206275	-1014	10	M14X1.5	30,0	16,0	30,0	15,5	12,0	22,0	19,0	8,0	19,0
1206276	-1216	12	M16X1.5	37,0	18,0	33,0	18,0	12,0	27,0	22,0	10,0	21,0
1206154	-1518	15	M18X1.5	40,0	20,0	36,0	21,0	12,0	30,0	27,0	12,0	23,0
1207055	-1822	18	M22X1.5	46,0	23,0	38,0	21,5	14,0	36,0	32,0	14,0	27,0
1211011	-2226	22	M26X1.5	51,0	25,0	42,0	26,0	16,0	41,0	36,0	17,0	31,0
1211012	-2833	28	M33X2.0	64,0	32,0	48,0	31,5	18,0	50,0	41,0	22,0	39,0
1211013	-3542	35	M42X2	76,0	37,0	57,0	35,5	20,0	60,0	50,0	27,0	49,0

Dimensions shown may be changed without prior notice

## // R1A12ME50M

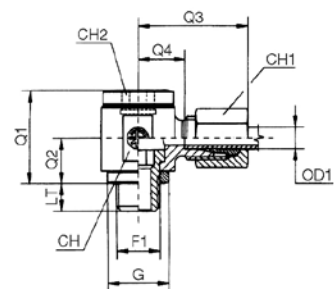
**Banjo adjustable - Type B - Metric cylindric DIN 24° - Heavy series**

Item Code	Head 1 / Head 2	OD1	F1	Q1	Q2	Q3	Q4	LT	CH	CH1	CH2	G
	mm			mm	mm	mm	mm		mm	mm	mm	
1206895	-0612	6	M12X1.5	30,0	15,0	31,0	16,5	12,0	22,0	17,0	6,0	17,0
1207058	-0814	8	M14X1.5	30,0	16,0	31,0	16,5	12,0	22,0	19,0	8,0	19,0
1206155	-1016	10	M16X1.5	37,0	18,0	35,0	18,5	12,0	27,0	22,0	10,0	21,0
1206156	-1218	12	M18X1.5	41,0	20,0	37,0	20,5	12,0	30,0	24,0	12,0	23,0
1206844	-1420	14	M20X1.5	42,0	21,0	41,0	23,0	14,0	32,0	27,0	12,0	25,0
1208221	-1622	16	M22X1.5	46,0	23,0	41,0	22,5	14,0	36,0	30,0	14,0	27,0
1207465	-2027	20	M27X2	58,0	28,0	49,0	27,5	16,0	46,0	36,0	17,0	32,0
1211200	-2533	25	M33X2.0	64,0	32,0	55,0	31,0	18,0	50,0	46,0	22,0	39,0
1208222	-3042	30	M42X2	76,0	37,0	63,0	36,5	20,0	60,0	50,0	27,0	49,0
1206157	-3848	38	M48X2.0	85,0	42,0	72,0	41,0	22,0	70,0	60,0	32,0	55,0

// BSPP

// R1A11M106M

Straight connector DIN 24° Male - BSPP thread cylindric flat - Light series

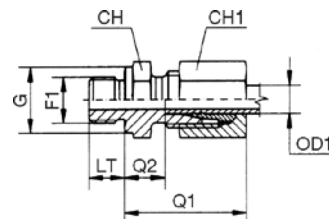

Item Code	Head 1 / Head 2	OD1	F1	Q1	Q2	CH	CH1	LT	G
	mm								
1205740	-0602	6	1/8-28	23,0	8,5	14,0	14,0	8,0	14,0
1204273	-0604	6	1/4-19	25,0	10,0	19,0	14,0	12,0	18,0
1206930	-0606	6	3/8-19	26,0	11,5	22,0	14,0	12,0	22,0
1205528	-0804	8	1/4-19	25,0	10,0	19,0	17,0	12,0	18,0
1204274	-0806	8	3/8-19	26,0	11,5	22,0	17,0	12,0	22,0
1206597	-0808	8	1/2-14	27,0	12,0	27,0	17,0	14,0	26,0
1204262	-1004	10	1/4-19	26,0	11,0	19,0	19,0	12,0	18,0
1204264	-1006	10	3/8-19	27,0	12,5	22,0	19,0	12,0	22,0
1204260	-1008	10	1/2-14	28,0	13,0	27,0	19,0	14,0	26,0
1205549	-1204	12	1/4-19	27,0	12,0	19,0	22,0	12,0	18,0
1204268	-1206	12	3/8-19	27,0	12,5	22,0	22,0	12,0	22,0
1204267	-1208	12	1/2-14	28,0	13,0	27,0	22,0	14,0	26,0
1204271	-1506	15	3/8-19	29,0	13,5	24,0	27,0	12,0	22,0
1204270	-1508	15	1/2-14	29,0	14,0	27,0	27,0	14,0	26,0
1205741	-1808	18	1/2-14	31,0	14,5	27,0	32,0	14,0	26,0
1205742	-1812	18	3/4-14	30,0	14,5	32,0	32,0	16,0	32,0
1205743	-2212	22	3/4-14	33,0	16,5	32,0	36,0	16,0	32,0
1205744	-2816	28	1-11	34,0	17,5	41,0	41,0	18,0	39,0
1205481	-3520	35	1 1/4-11	39,0	17,5	50,0	50,0	20,0	49,0
1206911	-4224	42	1 1/2-11	42,0	19,0	55,0	60,0	22,0	55,0

// R1A12M106M

Straight connector DIN 24° Male - BSPP thread cylindric flat - Heavy series

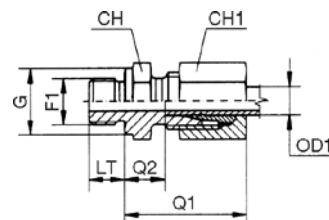

Item Code	Head 1 / Head 2	OD1	F1	Q1	Q2	CH	CH1	LT	G
	mm								
1206096	-0604	6	1/4-19	28,0	13,0	19,0	17,0	12,0	18,0
1205745	-0804	8	1/4-19	30,0	15,0	19,0	19,0	12,0	18,0
1205582	-1006	10	3/8-19	31,0	15,0	22,0	22,0	12,0	22,0
1205746	-1206	12	3/8-19	33,0	17,0	22,0	24,0	12,0	22,0
1206014	-1208	12	1/2-14	34,0	17,5	27,0	24,0	14,0	26,0
1205748	-1408	14	1/2-14	37,0	19,0	27,0	27,0	14,0	26,0
1205750	-1608	16	1/2-14	37,0	18,5	27,0	30,0	14,0	26,0
1205884	-1612	16	3/4-14	39,0	20,5	32,0	30,0	16,0	32,0
1205751	-2012	20	3/4-14	42,0	20,5	32,0	36,0	16,0	32,0
1205752	-2516	25	1-11	47,0	23,0	41,0	46,0	18,0	39,0
1205753	-3020	30	1 1/4-11	50,0	23,5	50,0	50,0	20,0	49,0
1205754	-3824	38	1 1/2-11	57,0	26,0	55,0	60,0	22,0	55,0

Dimensions shown may be changed without prior notice

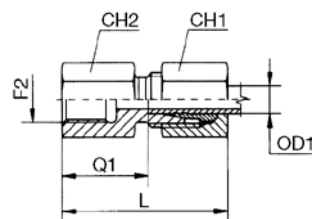
**// R1A11M106F****Straight connector DIN 24° Male - Female BSPP cylindric - Light series**

Item Code	Head 1 / Head 2	OD1 mm	F2	Q1 mm	CH mm	CH1 mm	L mm
	mm/Dash						
1206267	-0602	6	1/8-28	19,0	14,0	14,0	34,0
1205799	-0804	8	1/4-19	24,0	17,0	19,0	39,0
1206996	-0806	8	3/8-19	25,0	17,0	24,0	40,0
1205800	-1004	10	1/4-19	25,0	19,0	19,0	40,0
1205801	-1206	12	3/8-19	26,0	22,0	24,0	41,0
1205802	-1508	15	1/2-14	31,0	27,0	27,0	46,0
1205803	-1808	18	1/2-14	30,5	32,0	27,0	47,0
1205547	-2212	22	3/4-14	35,5	36,0	36,0	52,0
1205804	-2816	28	1-11	38,0	41,0	41,0	55,0
1206998	-3520	35	1 1/4-11	41,0	50,0	55,0	63,0
1208155	-4224	42	1 1/2-11	42,5	60,0	60,0	65,0

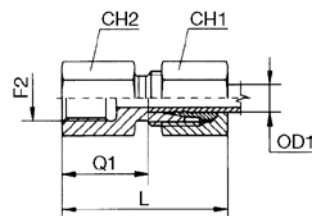
**// R1A12M106F****Straight connector DIN 24° Male - Female BSPP cylindric - Heavy series**

Item Code	Head 1 / Head 2	OD1 mm	F2	Q1 mm	CH mm	CH1 mm	L mm
	mm/Dash						
1206364	-0604	6	1/4-19	26,0	17,0	19,0	41,0
1205805	-0804	8	1/4-19	26,0	19,0	19,0	41,0
1206365	-1206	12	3/8-19	26,5	24,0	24,0	43,0
1205806	-1408	14	1/2-14	32,0	27,0	30,0	50,0
1205807	-1608	16	1/2-14	31,5	30,0	30,0	50,0
1206268	-2012	20	3/4-14	34,5	36,0	36,0	56,0
1205808	-2516	25	1-11	37,5	46,0	41,0	62,0
1207021	-3020	30	1 1/4-11	42,0	50,0	55,0	69,0
1207143	-3824	38	1 1/2-11	43,5	60,0	60,0	74,0



**// R1A11M106I**

**Straight connector DIN 24° Male - BSPP thread cylindric with elastomer - Light series**

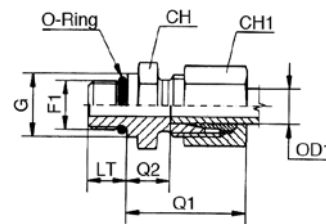

Item Code	Head 1 / Head 2	OD1	F1	Q1	Q2	CH	CH1	LT	G
	mm								
1206131	-0602	6	1/8-28	23,0	8,5	14,0	14,0	8,0	14,0
1205490	-0804	8	1/4-19	25,0	10,0	19,0	17,0	12,0	19,0
1205760	-1004	10	1/4-19	26,0	11,0	19,0	19,0	12,0	19,0
1205488	-1206	12	3/8-19	27,0	12,5	22,0	22,0	12,0	22,0
1205489	-1508	15	1/2-14	29,0	14,0	27,0	27,0	14,0	27,0
1206040	-1808	18	1/2-14	31,0	14,5	27,0	32,0	14,0	27,0
1205761	-2212	22	3/4-14	33,0	16,5	32,0	36,0	16,0	32,0
1206056	-2816	28	1-11	34,0	17,5	41,0	41,0	18,0	40,0
1206283	-3520	35	1 1/4-11	39,0	17,5	50,0	50,0	20,0	50,0
1206039	-4224	42	1 1/2-11	42,0	19,0	55,0	60,0	22,0	55,0

**// R1A12M106I**

**Straight connector DIN 24° Male - BSPP thread cylindric with elastomer - Heavy series**

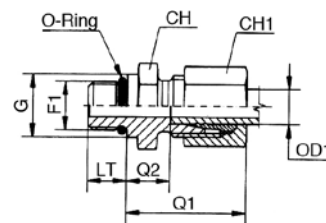

Item Code	Head 1 / Head 2	OD1	F1	Q1	Q2	CH	CH1	LT	G
	mm								
1206133	-0604	6	1/4-19	28,0	13,0	19,0	17,0	12,0	19,0
1206049	-0804	8	1/4-19	30,0	15,0	19,0	19,0	12,0	19,0
1206134	-1006	10	3/8-19	31,0	15,0	22,0	22,0	12,0	22,0
1205901	-1206	12	3/8-19	33,0	17,0	22,0	24,0	12,0	22,0
1205762	-1408	14	1/2-14	37,0	19,0	27,0	27,0	14,0	27,0
1205763	-1608	16	1/2-14	37,0	18,5	27,0	30,0	14,0	27,0
1205764	-2012	20	3/4-14	42,0	20,5	32,0	36,0	16,0	32,0
1206047	-2516	25	1-11	47,0	23,0	41,0	46,0	18,0	40,0
1206416	-3020	30	1 1/4-11	50,0	23,5	50,0	50,0	20,0	50,0
1207842	-3820	38	1 1/4-11	57,0	26,0	55,0	60,0	20,0	50,0

Dimensions shown may be changed without prior notice

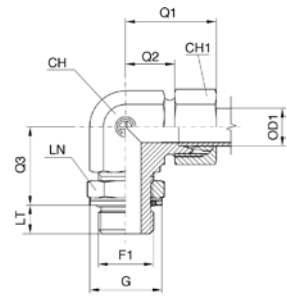
**// R1A11M906N****90° adjustable elbow connector DIN 24° Male - BSPP cylindric  
Male with O-Ring and retaining ring - Light series**

Item Code	Head 1 / Head 2	OD1	F1	Q1	Q2	Q3	CH	CH1	LN	LT	G
	mm/Dash										
1211135	-0602	6	1/8-28	29,0	14,0	20,2	14,0	14,0	14,0	6,3	16,0
1240312	-0804	8	1/4-19	31,0	16,0	22,5	14,0	17,0	19,0	9,5	20,5
1208111	-1004	10	1/4-19	32,0	17,0	24,5	19,0	19,0	19,0	9,5	20,5
1239726	-1206	12	3/8-19	34,0	19,0	27,5	19,0	22,0	22,0	9,5	24,0
1239727	-1508	15	1/2-14	36,0	21,0	30,0	22,0	27,0	27,0	13,0	29,0
1210735	-1808	18	1/2-14	40,0	24,0	36,5	27,0	32,0	27,0	13,0	29,0
1238730	-2212	22	3/4-14	44,0	28,0	37,5	33,0	36,0	36,0	13,0	35,0
1239728	-2816	28	1-11	47,0	31,0	41,0	41,0	41,0	41,0	16,0	44,5
1211136	-3520	35	1 1/4-11	59,0	38,0	49,0	48,0	50,0	50,0	16,0	53,0
1208116	-4224	42	1 1/2-11	61,0	38,0	51,0	48,0	60,0	55,0	16,0	58,5

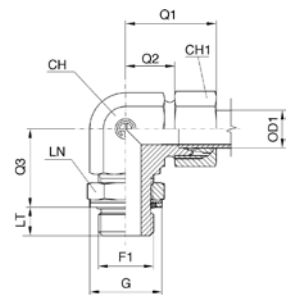
**// R1A12M906N****90° adjustable elbow connector DIN 24° Male - BSPP cylindric  
Male with O-Ring and retaining ring - Heavy series**

Item Code	Head 1 / Head 2	OD1	F1	Q1	Q2	Q3	CH	CH1	LN	LT	G
	mm/Dash										
1211298	-0604	6	1/4-19	30,5	15,5	22,5	14,0	17,0	19,0	9,5	20,5
1208092	-0804	8	1/4-19	33,0	18,0	26,5	19,0	19,0	19,0	9,5	20,5
1208093	-1006	10	3/8-19	34,0	18,0	28,5	19,0	22,0	22,0	9,5	24,0
1208094	-1206	12	3/8-19	38,0	22,0	28,5	22,0	24,0	22,0	9,5	24,0
1208095	-1608	16	1/2-14	43,0	25,0	36,0	27,0	30,0	27,0	13,0	29,0
1208096	-2012	20	3/4-14	49,0	28,0	38,0	33,0	36,0	36,0	13,0	35,0
1208097	-2516	25	1-11	54,5	30,5	41,0	41,0	46,0	41,0	16,0	44,5
1211299	-3020	30	1 1/4-11	62,0	36,0	48,0	48,0	50,0	50,0	16,0	53,0
1211300	-3824	38	1 1/2-11	65,0	34,0	53,0	48,0	60,0	55,0	16,0	58,5

**// R1A11MT06N**

**Branch Tee adjustable elbow connector DIN 24° Male - BSPP  
Male with O-Ring - Light series**

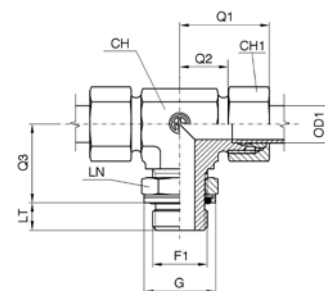

Item Code	Head 1 / Head 2	OD1	F1	Q1	Q2	Q3	CH	CH1	LN	LT	G
	mm/Dash										
1211050	-0602	6	M12X1.5	29,0	14,0	20,2	14,0	14,0	14,0	6,3	16,0
1211051	-0804	8	M14X1.5	31,0	16,0	22,5	14,0	17,0	19,0	9,5	20,5
1211052	-1004	10	M16X1.5	32,0	17,0	24,5	19,0	19,0	19,0	9,5	20,5
1211053	-1206	12	M18X1.5	34,0	19,0	27,5	19,0	22,0	22,0	9,5	24,0
1237042	-1508	15	M22X1.5	36,0	21,0	30,0	22,0	27,0	27,0	13,0	29,0
1211055	-1808	18	M26X1.5	40,0	24,0	36,5	27,0	32,0	27,0	13,0	29,0
1211056	-2212	22	M30X2	44,0	28,0	37,5	33,0	36,0	36,0	13,0	35,0
1231369	-2816	28	M36X2	47,0	31,0	41,0	41,0	41,0	41,0	16,0	44,5
1208182	-3520	35	M45X2	59,0	38,0	49,0	48,0	50,0	50,0	16,0	53,0
1211058	-4224	42	M52X2	61,0	38,0	51,0	48,0	60,0	55,0	16,0	58,5

**// R1A12MT06N**

**Branch Tee adjustable elbow connector DIN 24° Male - BSPP  
Male with O-Ring - Heavy series**

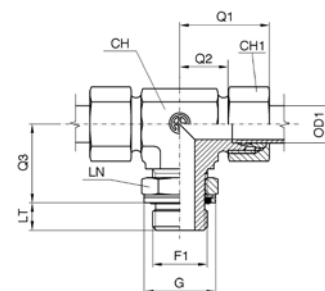

Item Code	Head 1 / Head 2	OD1	F1	Q1	Q2	Q3	CH	CH1	LN	LT	G
	mm/Dash										
1211236	-0604	6	M14X1.5	30,5	15,5	22,5	14,0	17,0	19,0	9,5	20,5
1231381	-0804	8	M16X1.5	33,0	18,0	26,5	19,0	19,0	19,0	9,5	20,5
1211238	-1006	10	M18X1.5	34,0	18,0	28,5	19,0	22,0	22,0	9,5	24,0
1211239	-1206	12	M20X1.5	38,0	22,0	28,5	22,0	24,0	22,0	9,5	24,0
1211240	-1608	16	M24X1.5	43,0	25,0	36,0	27,0	30,0	27,0	13,0	29,0
1211241	-2012	20	M30X2	49,0	28,0	38,0	33,0	36,0	36,0	13,0	35,0
1211242	-2516	25	M36X2	54,5	30,5	41,0	41,0	46,0	41,0	16,0	44,5
1211243	-3020	30	M42X2	62,0	36,0	48,0	48,0	50,0	50,0	16,0	53,0
1211244	-3824	38	M52X2	65,0	34,0	53,0	48,0	60,0	55,0	16,0	58,5

Dimensions shown may be changed without prior notice

### // R1A11ML06N

Run Tee adjustable elbow connector DIN 24° Male - BSPP Male with O-Ring - Light series

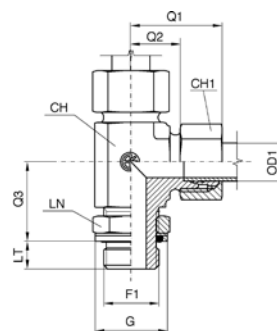

Item Code	Head 1 / Head 2	OD1	F1	Q1	Q2	Q3	CH	CH1	LN	LT	G
	mm/Dash										
1211019	-0602	6	1/8-28	29,0	14,0	20,2	14,0	14,0	14,0	6,3	16,0
1210734	-0804	8	1/4-19	31,0	16,0	22,5	14,0	17,0	19,0	9,5	20,5
1211020	-1004	10	1/4-19	32,0	17,0	24,5	19,0	19,0	19,0	9,5	20,5
1211021	-1206	12	3/8-19	34,0	19,0	27,5	19,0	22,0	22,0	9,5	24,0
1211022	-1508	15	1/2-14	36,0	21,0	30,0	22,0	27,0	27,0	13,0	29,0
1211023	-1808	18	1/2-14	40,0	24,0	36,5	27,0	32,0	27,0	13,0	29,0
1231368	-2212	22	3/4-14	44,0	28,0	37,5	33,0	36,0	36,0	13,0	35,0
1211025	-2816	28	1-11	47,0	31,0	41,0	41,0	41,0	41,0	16,0	44,5
1211026	-3520	35	1 1/4-11	59,0	38,0	49,0	48,0	50,0	50,0	16,0	53,0
1211027	-4224	42	1 1/2-11	61,0	38,0	51,0	48,0	60,0	55,0	16,0	58,5

### // R1A12ML06N

Run Tee adjustable elbow connector DIN 24° Male - BSPP Male with O-Ring - Heavy series

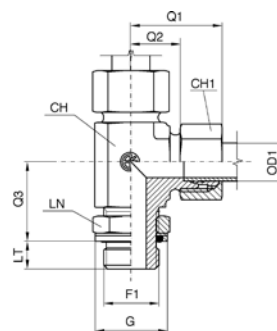

Item Code	Head 1 / Head 2	OD1	F1	Q1	Q2	Q3	CH	CH1	LN	LT	G
	mm/Dash										
1211207	-0604	6	1/4-19	30,5	15,5	22,5	14,0	17,0	19,0	9,5	20,5
1231380	-0804	8	1-11	33,0	18,0	26,5	19,0	19,0	19,0	9,5	20,5
1211209	-1006	10	3/8-19	34,0	18,0	28,5	19,0	22,0	22,0	9,5	24,0
1211210	-1206	12	3/8-19	38,0	22,0	28,5	22,0	24,0	22,0	9,5	24,0
1211211	-1608	16	1/2-14	43,0	25,0	36,0	27,0	30,0	27,0	13,0	29,0
1211212	-2012	20	3/4-14	49,0	28,0	38,0	33,0	36,0	36,0	13,0	35,0
1211213	-2516	25	1-11	54,5	30,5	41,0	41,0	46,0	41,0	16,0	44,5
1211214	-3020	30	1 1/4-11	62,0	36,0	48,0	48,0	50,0	50,0	16,0	53,0
1211215	-3824	38	1 1/2-11	65,0	34,0	53,0	48,0	60,0	55,0	16,0	58,5

**// R1A152106I**

**Straight connector DIN 24° Female with O-Ring - BSPP thread  
cylindric with elastomer - Light series**

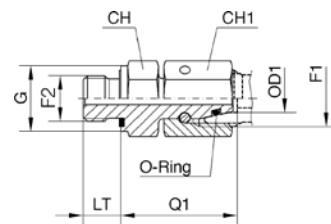

Item Code	Head 1 / Head 2	OD1	F1	F2	Q1	LT	CH	CH1	G
	mm								
1211383	-0602	6	M12X1.5	1/8-28	24,5	8,0	14,0	14,0	14,0
1206931	-0804	8	M14X1.5	1/4-19	29,5	12,0	19,0	17,0	19,0
1206814	-1004	10	M16X1.5	1/4-19	27,5	12,0	19,0	19,0	19,0
1206558	-1206	12	M18X1.5	3/8-19	34,0	12,0	22,0	22,0	22,0
1208084	-1508	15	M22X1.5	1/2-14	32,0	14,0	27,0	27,0	27,0
1208044	-1808	18	M26X1.5	1/2-14	31,5	14,0	27,0	32,0	27,0
1208085	-2212	22	M30X2	3/4-14	32,5	16,0	32,0	36,0	32,0
1211384	-2816	28	M36X2	1-11	35,0	18,0	41,0	41,0	40,0
1211385	-3520	35	M45X2	1 1/4-11	42,5	20,0	50,0	50,0	50,0
1211386	-4224	42	M52X2	1 1/2-11	46,5	22,0	55,0	60,0	55,0

**// R1A162106I**

**Straight connector DIN 24° Female with O-Ring - BSPP thread  
cylindric with elastomer - Heavy series**

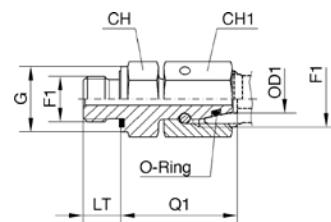

Item Code	Head 1 / Head 2	OD1	F1	F2	Q1	LT	CH	CH1	G
	mm								
1211448	-0604	6	M14X1.5	1/4-19	27,0	12,0	19,0	17,0	19,0
1206834	-0804	8	M16X1.5	1/4-19	29,5	12,0	19,0	19,0	19,0
1208168	-1006	10	M18X1.5	3/8-19	32,0	12,0	22,0	22,0	22,0
1208169	-1206	12	M20X1.5	3/8-19	34,0	12,0	22,0	24,0	22,0
1208170	-1408	14	M22X1.5	1/2-14	36,5	14,0	27,0	27,0	27,0
1206561	-1608	16	M24X1.5	1/2-14	37,0	14,0	27,0	30,0	27,0
1207555	-2012	20	M30X2	3/4-14	43,0	16,0	32,0	36,0	32,0
1207131	-2516	25	M36X2	1-11	48,0	18,0	41,0	46,0	40,0
1207544	-3020	30	M42X2	1 1/4-11	51,0	20,0	50,0	50,0	50,0
1211449	-3824	38	M52X2	1 1/2-11	60,0	22,0	55,0	60,0	55,0

Dimensions shown may be changed without prior notice

## // R1A113106I

**Straight connector DIN 24° Female pre-assembled - BSPP  
thread cylindric with elastomer - Light series**

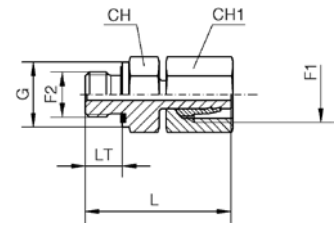

Item Code	Head 1 / Head 2	OD1	F1	F2	LT	CH	CH1	G	L
	mm								
1206303	-0602	6	M12X1.5	1/8-28	8,0	14,0	14,0	14,0	32,5
1205583	-0804	8	M14X1.5	1/4-19	12,0	19,0	17,0	19,0	41,5
1205573	-1004	10	M16X1.5	1/4-19	12,0	19,0	19,0	19,0	39,5
1205553	-1206	12	M18X1.5	3/8-19	12,0	22,0	22,0	22,0	46,0
1205554	-1508	15	M22X1.5	1/2-14	14,0	27,0	27,0	27,0	46,0
1205766	-1808	18	M26X1.5	1/2-14	14,0	27,0	32,0	27,0	45,5
1205555	-2212	22	M30X2	3/4-14	16,0	32,0	36,0	32,0	48,5
1206073	-2816	28	M36X2	1-11	18,0	41,0	41,0	40,0	53,0
1206000	-3520	35	M45X2	1 1/4-11	20,0	50,0	50,0	50,0	62,5
1206492	-4224	42	M52X2	1 1/2-11	22,0	55,0	60,0	55,0	68,5

## // R1A123106I

**Straight connector DIN 24° Female pre-assembled - BSPP  
thread cylindric with elastomer - Heavy series**

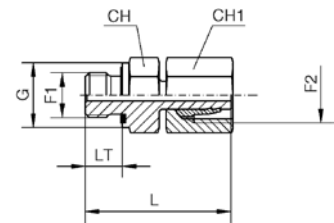

Item Code	Head 1 / Head 2	OD1	F1	F2	LT	CH	CH1	G	L
	mm								
1206485	-0604	6	M14X1.5	1/4-19	12,0	19,0	17,0	19,0	39,0
1206035	-0804	8	M16X1.5	1/4-19	12,0	19,0	19,0	19,0	41,5
1206487	-1006	10	M18X1.5	3/8-19	12,0	22,0	22,0	22,0	44,5
1206034	-1206	12	M20X1.5	3/8-19	12,0	22,0	24,0	22,0	46,0
1206033	-1408	14	M22X1.5	1/2-14	14,0	27,0	27,0	27,0	51,0
1206032	-1608	16	M24X1.5	1/2-14	14,0	27,0	30,0	27,0	50,5
1206031	-2012	20	M30X2	3/4-14	16,0	32,0	36,0	32,0	59,0
1206030	-2516	25	M36X2	1-11	18,0	41,0	46,0	40,0	66,0
1206490	-3020	30	M42X2	1 1/4-11	20,0	50,0	50,0	50,0	71,0
1206491	-3824	38	M52X2	1 1/2-11	22,0	55,0	60,0	55,0	82,0

**// R1A11M903M**

**Banjo elbow - Type A - BSPP Male DIN 24° - Light series**

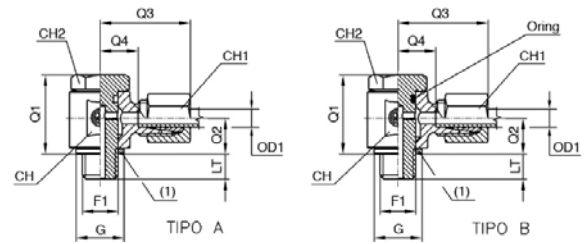

Item Code	Head 1 / Head 2	OD1	F1	Q1	Q2	Q3	Q4	LT	CH	CH1	CH2	G
	mm			mm	mm	mm	mm	mm	mm	mm	mm	
1206576	-0602	6	1/8-28	27,0	12,5	29,0	13,0	8,0	19,0	14,0	17,0	15,0
1206148	-0804	8	1/4-19	30,5	15,0	30,5	14,5	12,0	22,0	17,0	19,0	18,0
1206149	-1004	10	1/4-19	30,5	15,0	32,0	15,5	12,0	22,0	19,0	19,0	18,0
1206150	-1206	12	3/8-19	38,5	19,0	36,0	19,5	12,0	30,0	22,0	24,0	22,0
1206530	-1508	15	1/2-14	48,0	23,0	39,0	22,5	14,0	36,0	27,0	27,0	26,0
1206531	-1808	18	1/2-14	48,0	23,0	40,0	22,0	14,0	36,0	32,0	27,0	26,0
1207006	-2212	22	1/8-28	56,0	26,0	47,0	28,0	16,0	41,0	36,0	32,0	32,0

**// R1A12M903M**

**Banjo elbow - Type A - BSPP Male DIN 24° - Heavy series**

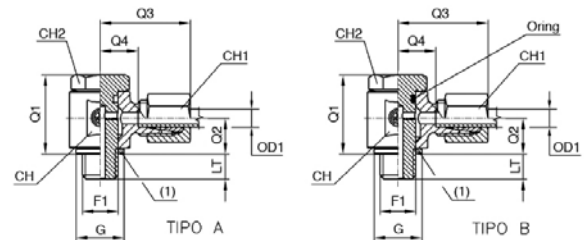

Item Code	Head 1 / Head 2	OD1	F1	Q1	Q2	Q3	Q4	LT	CH	CH1	CH2	G
	mm			mm	mm	mm	mm	mm	mm	mm	mm	
1206098	-0604	6	1/4-19	30,5	15,0	33,0	16,5	12,0	22,0	17,0	19,0	18,0
1207025	-0804	8	1/4-19	30,5	15,0	32,5	16,5	12,0	22,0	19,0	19,0	18,0
1206532	-1006	10	3/8-19	38,5	19,0	38,0	20,0	12,0	30,0	22,0	24,0	22,0
1206151	-1206	12	3/8-19	38,5	19,0	38,0	20,0	12,0	30,0	24,0	24,0	22,0
1206582	-1408	14	1/2-14	48,0	23,0	42,5	23,5	14,0	36,0	27,0	27,0	26,0
1206533	-1608	16	1/2-14	48,0	23,0	43,0	23,0	14,0	36,0	30,0	27,0	26,0
1206583	-2012	20	3/4-14	56,0	26,0	51,5	27,0	16,0	41,0	36,0	32,0	32,0

Dimensions shown may be changed without prior notice

## // R1A11ME03M

## Banjo elbow - Type B - BSPP Male DIN 24° - Light series

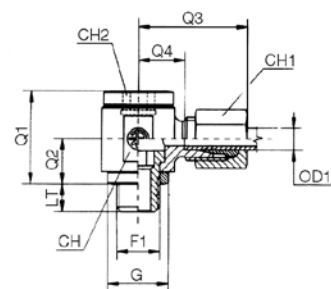

Item Code	Head 1 / Head 2	OD1	F1	Q1	Q2	Q3	Q4	LT	CH	CH1	CH2	G
	mm			mm	mm	mm	mm		mm	mm	mm	
1207054	-0602	6	1/8-28	24,0	12,0	27,0	12,5	8,0	19,0	14,0	6,0	14,0
1206158	-0804	8	1/4-19	30,0	16,0	29,0	14,5	12,0	22,0	17,0	8,0	18,0
1242126	-1004	10	1/4-19	30,0	16,0	30,0	15,5	12,0	22,0	19,0	8,0	18,0
1206160	-1206	12	3/8-19	37,0	18,0	33,0	18,0	12,0	27,0	22,0	10,0	22,0
1206277	-1508	15	1/2-14	42,0	21,0	37,0	22,0	14,0	32,0	27,0	12,0	26,0
1211007	-1808	18	1/2-14	46,0	23,0	38,0	21,5	14,0	36,0	32,0	12,0	26,0
1211008	-2212	22	3/4-14	58,0	28,0	45,0	28,5	16,0	46,0	36,0	17,0	32,0
1208107	-2816	28	1-11	64,0	32,0	48,0	31,5	18,0	50,0	41,0	22,0	39,0
1206161	-3520	35	1 1/4-11	76,0	37,0	57,0	35,5	20,0	60,0	50,0	27,0	49,0
1211009	-4224	42	1 1/2-11	85,0	42,0	63,0	40,0	22,0	70,0	60,0	32,0	55,0

## // R1A12ME03M

## Banjo elbow - Type B - BSPP Male DIN 24° - Heavy series

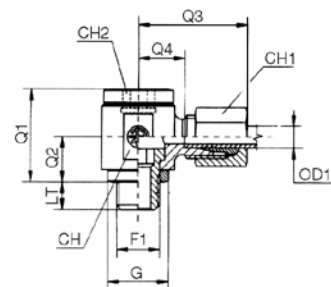

Item Code	Head 1 / Head 2	OD1	F1	Q1	Q2	Q3	Q4	LT	CH	CH1	CH2	G
	mm			mm	mm	mm	mm		mm	mm	mm	
1206114	-0604	6	1/4-19	30,0	16,0	31,0	16,5	12,0	22,0	17,0	8,0	18,0
1206115	-0804	8	1/4-19	30,0	16,0	31,0	16,5	12,0	22,0	19,0	8,0	18,0
1206116	-1006	10	3/8-19	37,0	18,0	35,0	18,5	12,0	27,0	22,0	10,0	22,0
1206117	-1206	12	3/8-19	37,0	18,0	35,0	18,5	12,0	27,0	24,0	10,0	22,0
1207059	-1408	14	1/2-14	42,0	21,0	41,0	23,0	14,0	32,0	27,0	12,0	26,0
1211197	-2012	20	3/4-14	58,0	28,0	49,0	27,5	16,0	46,0	36,0	17,0	32,0
1211198	-2516	25	1-11	64,0	32,0	55,0	31,0	18,0	50,0	46,0	22,0	39,0
1211199	-3020	30	1 1/4-11	76,0	37,0	63,0	36,5	20,0	60,0	50,0	27,0	49,0
1208220	-3824	38	1 1/2-11	85,0	42,0	72,0	41,0	22,0	70,0	60,0	32,0	55,0



**// R1A06F106I**

**Straight connector BSPP Female - BSPP thread Male with elastomer**

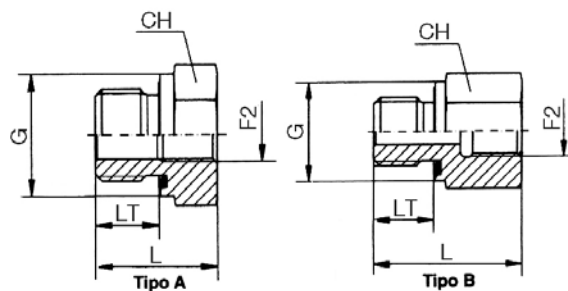

Item Code	Head 1 / Head 2	F2	CH	L	LT	G
	Dash		mm	mm	mm	mm
1206431	-0204	1/4-19	19,0	31,0	8,0	14,0
1206511	-0206	3/8-19	24,0	32,0	8,0	14,0
1206510	-0402	1/8-28	19,0	29,0	12,0	19,0
1206432	-0406	3/8-19	24,0	36,0	12,0	19,0
1206016	-0408	1/2-14	30,0	40,0	12,0	19,0
1206512	-0412	3/4-14	36,0	43,0	12,0	19,0
1206509	-0602	1/8-28	22,0	22,5	12,0	22,0
1206508	-0604	1/4-19	22,0	36,0	12,0	22,0
1206513	-0608	1/2-14	30,0	41,0	12,0	22,0
1206514	-0612	3/4-14	36,0	44,0	12,0	22,0
1207863	-0802	1/8-28	27,0	24,0	14,0	27,0
1206507	-0804	1/4-19	27,0	24,0	14,0	27,0
1206506	-0806	3/8-19	27,0	37,0	14,0	27,0
1206515	-0812	3/4-14	36,0	46,0	14,0	27,0
1206420	-0816	1-11	41,0	49,0	14,0	27,0
1206516	-0820	1 1/4-11	55,0	53,0	14,0	27,0
1206505	-1204	1/4-19	32,0	26,0	16,0	32,0
1206504	-1206	3/8-19	32,0	26,0	16,0	32,0
1206419	-1208	1/2-14	32,0	43,0	16,0	32,0
1206418	-1216	1-11	41,0	51,0	16,0	32,0
1206422	-1220	1 1/4-11	55,0	55,0	16,0	32,0
1206421	-1224	1 1/2-11	60,0	57,0	16,0	32,0
1206503	-1604	1/4-19	41,0	29,0	18,0	40,0
1206502	-1606	3/8-19	41,0	29,0	18,0	40,0
1206501	-1608	1/2-14	41,0	29,0	18,0	40,0
1206500	-1612	3/4-14	41,0	49,0	18,0	40,0
1206517	-1620	1 1/4-11	55,0	57,0	18,0	40,0
1206518	-1624	1 1/2-11	60,0	59,0	18,0	40,0
1206499	-2008	1/2-14	50,0	32,0	20,0	50,0
1206497	-2012	3/4-14	50,0	32,0	20,0	50,0
1206465	-2016	1-11	50,0	53,0	20,0	50,0
1206519	-2024	1 1/2-11	60,0	60,0	20,0	50,0
1206496	-2408	1/2-14	55,0	36,0	22,0	55,0
1206495	-2412	3/4-14	55,0	36,0	22,0	55,0
1206494	-2416	1-11	55,0	36,0	22,0	55,0
1206493	-2420	1 1/4-11	55,0	58,0	22,0	55,0

Dimensions shown may be changed without prior notice

## // BUTT WELD

## // R1A11M100S

Butt Weld straight coupling DIN 24° - Light series

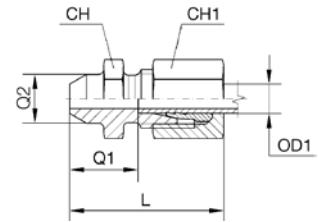

Item Code	Head	OD1	Q1	Q2	CH	CH1	L
	mm						
1211088	-0600	6	14,0	10,0	12,0	14,0	29,0
1211089	-0800	8	16,0	12,0	14,0	17,0	31,0
1211090	-1000	10	18,0	14,0	17,0	19,0	33,0
1211091	-1200	12	18,0	16,0	19,0	22,0	33,0
1211092	-1500	15	22,0	19,0	22,0	27,0	37,0
1211093	-1800	18	23,5	22,0	27,0	32,0	40,0
1211094	-2200	22	28,5	27,0	32,0	36,0	45,0
1211095	-2800	28	30,5	32,0	41,0	41,0	47,0
1211096	-3500	35	32,5	40,0	46,0	50,0	54,0
1210752	-4200	42	35,0	46,0	55,0	60,0	58,0

## // R1A12M100S

Butt Weld straight coupling DIN 24° - Heavy series

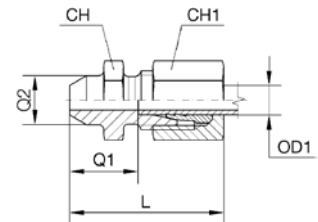

Item Code	Head	OD1	Q1	Q2	CH	CH1	L
	mm						
1211265	-0600	6	19,0	11,0	14,0	17,0	34,0
1211266	-0800	8	21,0	13,0	17,0	19,0	36,0
1208074	-1000	10	22,5	15,0	19,0	22,0	39,0
1206144	-1200	12	24,5	17,0	22,0	24,0	41,0
1211267	-1400	14	27,0	19,0	24,0	27,0	45,0
1211268	-1600	16	26,5	21,0	27,0	30,0	45,0
1207100	-2000	20	29,5	26,0	32,0	36,0	51,0
1208075	-2500	25	32,0	31,0	41,0	46,0	56,0
1211269	-3000	30	35,5	36,0	46,0	50,0	62,0

**// R1A11M111S**

**Butt Weld long straight coupling DIN 24° - Light series**

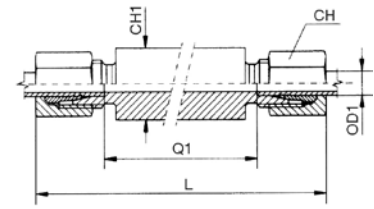

Item Code	Head 1 / Head 2	OD1	Q1	CH	CH1	L
	mm					
1211098	-0606	6	56,0	14,0	18,0	85,0
1211099	-0808	8	56,0	17,0	20,0	85,0
1211100	-1010	10	58,0	19,0	22,0	87,0
1211101	-1212	12	58,0	22,0	25,0	87,0
1211102	-1818	18	69,0	32,0	32,0	101,0
1211103	-2222	22	73,0	36,0	36,0	105,0
1211104	-2828	28	73,0	41,0	40,0	106,0
1211105	-3535	35	71,0	50,0	50,0	114,0
1211106	-4242	42	70,0	60,0	60,0	115,0

**// R1A12M112S**

**Butt Weld long straight coupling DIN 24° - Heavy series**

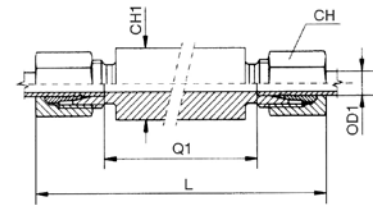

Item Code	Head 1 / Head 2	OD1	Q1	CH	CH1	L
	mm					
1211271	-0606	6	60,0	17,0	20,0	89,0
1211272	-0808	8	60,0	19,0	22,0	89,0
1208076	-1010	10	59,0	22,0	25,0	91,0
1211273	-1212	12	59,0	24,0	28,0	91,0
1211274	-1414	14	72,0	27,0	30,0	107,0
1211275	-1616	16	71,0	30,0	35,0	107,0
1211276	-2525	25	72,0	46,0	45,0	120,0
1211277	-3030	30	73,0	50,0	50,0	126,0
1211278	-3838	38	72,0	60,0	60,0	133,0

Dimensions shown may be changed without prior notice

## // ACCESSORIES

## // R1A11D0000

## Nut DIN 24° - Light series

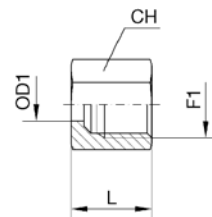

Item Code	Head	OD1 mm	F1	CH	L
	Dash			mm	mm
1204178	-0600	6	M12X1.5	14,0	14,50
1204181	-0800	8	M14X1.5	17,0	14,50
1204149	-1000	10	M16X1.5	19,0	15,50
1204152	-1200	12	M18X1.5	22,0	15,50
1204157	-1500	15	M22X1.5	27,0	17,00
1204160	-1800	18	M26X1.5	32,0	18,00
1204164	-2200	22	M30X2	36,0	20,00
1204167	-2800	28	M36X2	41,0	21,00
1204172	-3500	35	M45X2	50,0	24,00
1204177	-4200	42	M52X2	60,0	24,00

## // R1A12D0000

## Nut DIN 24° - Heavy series

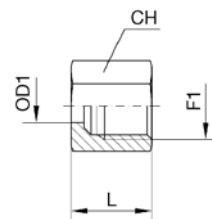

Item Code	Head	OD1 mm	F1	CH	L
	Dash			mm	mm
1204180	-0600	6	-	17,0	16,50
1204182	-0800	8	M16X1.5	19,0	16,50
1204151	-1000	10	M18X1.5	22,0	17,50
1204154	-1200	12	M20X1.5	24,0	17,50
1204156	-1400	14	M22X1.5	27,0	20,50
1204159	-1600	16	M24X1.5	30,0	20,50
1204163	-2000	20	M30X2	36,0	24,00
1204166	-2500	25	M36X2	46,0	27,00
1204170	-3000	30	M42X2	50,0	29,00
1204175	-3800	38	M52X2	60,0	32,50

## // R1A11R0000

## Double cutting ring DIN 24° - Light series

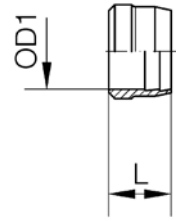

Item Code	Head	OD1	L
	Dash	in	mm
1204118	-1500	15	10,0
1204121	-1800	18	10,5
1204125	-2200	22	11,0
1204129	-2800	28	11,0
1204133	-3500	35	13,5
1204136	-4200	42	13,5

## // R1A12R0000

## Double cutting ring DIN 24° - Heavy series

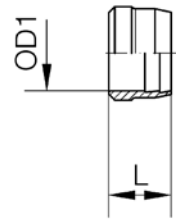

Item Code	Head	OD1	L
	Dash	in	mm
1204117	-1400	14	10,0
1204120	-1600	16	10,5
1204124	-2000	20	13,0
1204128	-2500	25	13,0
1204131	-3000	30	13,5
1204135	-3800	38	13,5

Dimensions shown may be changed without prior notice

## // PLUG

## // R1A15F0000

Plug with O-Ring 24° DIN 2353 - Light series

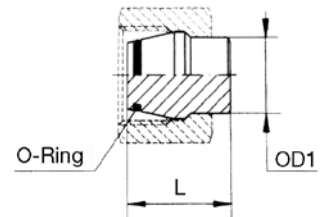

Item Code	Head	OD1	L
	Dash	in	mm
1208264	-0600	6	18,5
1208263	-0800	8	18,5
1208262	-1000	10	20,0
1208240	-1200	12	20,5
1208142	-1500	15	20,5
1208143	-1800	18	22,5
1208146	-2200	22	25,0
1208148	-2800	28	25,5
1208149	-3500	35	30,0
1208150	-4200	42	30,0

## // R1A16F0000

Plug with O-Ring 24° DIN 2353 - Heavy series

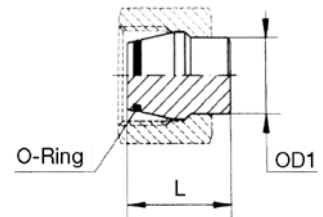

Item Code	Head	OD1	L
	Dash	in	mm
1208238	-0800	8	18,5
1208237	-1000	10	20,0
1208236	-1200	12	20,5
1208062	-1400	14	22,5
1208063	-1600	16	23,5
1208064	-2000	20	28,5
1208065	-2500	25	29,0
1208066	-3000	30	30,5
1208067	-3800	38	33,0

**// R1A50I0000**

**Socket head plug Metric cylindric with elastomer**

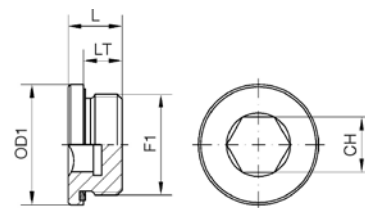

Item Code	Head	OD1	F1	CH	L	LT
	Dash					
1204050	-1000	-	M10X1.0	5,0	12,0	8,0
1206352	-1200	6	M12X1.5	6,0	17,0	12,0
1204051	-1400	8	M14X1.5	6,0	17,0	12,0
1204052	-1600	10	M16X1.5	8,0	17,0	12,0
1204053	-1800	12	M18X1.5	8,0	17,0	12,0
1204054	-2000	14	M20X1.5	10,0	19,0	14,0
1204055	-2200	15	M22X1.5	10,0	19,0	14,0
1204056	-2600	18	M26X1.5	12,0	21,0	16,0
1204057	-2700	-	M27X2	12,0	21,0	16,0
1206706	-3300	25	M33X2.0	17,0	22,5	16,0
1211886	-4200	-	M42X2	22,0	22,5	16,0
1207864	-4800	38	M48X2.0	24,0	22,5	16,0

**// R1A06I0000**

**Socket head plug BSPP cylindric with elastomer**

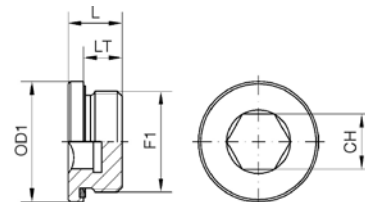

Item Code	Head	OD1	F1	CH	L	LT
	Dash					
1204044	-0200	1/8"	1/8-28	5,0	12,0	8,0
1204043	-0400	1/4"	1/4-19	6,0	17,0	12,0
1204049	-0600	3/8"	3/8-19	8,0	17,0	12,0
1204042	-0800	1/2"	1/2-14	10,0	19,0	14,0
1204048	-1200	3/4"	3/4-14	12,0	21,0	16,0
1204045	-1600	1"	1-11	17,0	22,5	16,0
1204047	-2000	1 1/4"	1 1/4-11	22,0	22,5	16,0
1204046	-2400	1 1/2"	1 1/2-11	24,0	22,5	16,0