



TUYAU FLEXIBLE INOX & RACCORDS (FR)
EDELSTAHLWELLSCHLÄUCHE & ARMATUREN (D)
TUBO FLESSIBILE CORRUGATO INOX & RACCORDI (I)
MANGUERA FLEXIBILE CORRUGADA INOX & RACORES (E)
RUSTFRI VECKAD STÅLSLANGAR & KOPPLINGAR (SV)
RUSTFRI STÅLSLANGE KORRUGERTE & KUPLINGER (NO)
RUSTFRI KORRUGERET STÅLSLANGE & KOBLINGER (DK)
HAPONKESTÄVÄT JOUSTAVAT LETKUT JA LIITTIMET (FI)



**STAINLESS STEEL CORRUGATED
FLEXIBLE HOSE & FITTINGS**

ALFAGOMMA

Stainless Steel flexible corrugated hose and fittings WELDING PLANTS

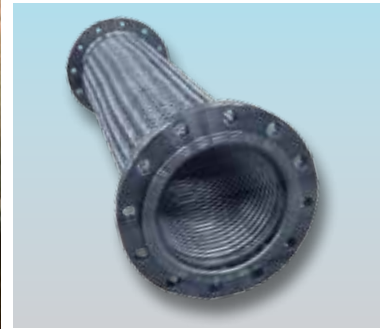

ALFAGOMMA

Alfagomma France
13 Rue Roger Salengro
62880 Vendin Le Veil
France

Alfagomma Hydraulic
Via Enrico Mattei, 8
64020 Castelnuovo Vomano
Teramo

DUNLOP HIFLEX

Dunlop Hiflex AB
Seldonsvägen 2
30262 Halmstad
Sweden

Dunlop Hiflex
A Division of Alfagomma Germany
Niederlassung Hamburg
Waidmannstraße 12
D-22769 Hamburg
Germany

99DMM

STAINLESS STEEL HOSE - PARALLEL CORRUGATION - AISI 316L WITH 1 BRAID AISI 304..... 6

- FR** FLEXIBLE INOX - ONDE PARALLELE - AISI 316L AVEC 1 TRESSE AISI 304
- D** EDELSTAHL-RINGWELLSCHLAUCH - NORMALE WELLUNG - 1.4404 (AISI 316L) MIT UMFLECHTUNG AUS 1.4301 (AISI304)
- I** TUBO ACCIAIO INOX - ONDULAZIONE PARALLELA - AISI 316L CON 1 TRECCIA AISI 304
- E** TUBO DE ACERO INOX - CORRUGACION PARALELA - AISI 316L CON UNA TRENZA AISI 304
- SV** ROSTFRRI STÅLSLANG, PARALLELLVECKAD. AISI316L (SS2353) MED ROSTFRRI FLÅTA AISI 304 (SS2333)
- NO** RUSTFRRI STÅLSLANGE - PARALLELLKORRUGERTE - AISI 316L MED 1 KRYSSFLETTING I AISI 304
- DK** RUSTFRRI STÅLSLANGE - PARALLEL KORRUGERET - AISI 316L MED 1 STÅLFLET I AISI 304
- FI** RUOSTUMATON KOKOMETALLILETKU-TIHEÄ POIMUJINEN RAKENNE PÄÄLLYS AISI 316L PUNOS AISI 304

99EMM

STAINLESS STEEL HOSE - PARALLEL NARROW CORRUGATION - AISI 316L WITH 1 BRAID AISI 304 7

- FR** FLEXIBLE INOX - ONDE PARALLELE RAPPROCHEE - AISI 316L AVEC 1 TRESSE AISI 304
- D** EDELSTAHL-RINGWELLSCHLAUCH - ENGE WELLUNG - 1.4404 (AISI 316L) MIT UMFLECHTUNG AUS 1.4301 (AISI304)
- I** TUBO ACCIAIO INOX - ONDULAZIONE PARALLELA RAVVICINATA - AISI 316L CON 1 TRECCIA AISI 304
- E** TUBO DE ACERO INOX - CORRUGACION PARALELA COMPRIMIDA - AISI 316L CON UNA TRENZA AISI 304
- SV** ROSTFRRI STÅLSLANG, PARALLELL TÅTVECKAD. AISI316L (SS2353) MED ROSTFRRI FLÅTA AISI304 (SS2333)
- NO** SYREFAST STÅLSLANGE - PARALLELL- OG TETTKORRUGERT - AISI 316L MED 1 KRYSSFLETTING I AISI 304
- DK** RUSTFRRI STÅLSLANGE - PARALLEL TÆT KORRUGERET - AISI 316L MED 1 STÅLFLET I AISI 304
- FI** RUOSTUMATON KOKOMETALLILETKU- TIHEA POIMUJINEN PÄÄLLYS AISI 316L PUNOS AISI 304

WELDING RING - STAINLESS STEEL AISI 304 10

- FR** BAGUE DE SOUDURE - INOX 304
- D** SCHWEISSRING - EDELSTAHL 1.4301 (AISI304)
- I** ANELLO A SILDARE - INOX 304
- E** CASQUILLO SOLDABLE - INOX 304
- SV** SVETS RING - SYRAFAST STÅL 304
- NO** SVEISERING - SYREFAST STÅL 304
- DK** SVEJSERING - RUSTFRIT STÅL 304
- FI** HOLKKI - AISI 304

FIXE FLANGE TYPE 11B WELDING NECK-RAISED FACE PN 10/16 - STEEL 12

- FR** BRIDE FIXE TYPE 11B A COLLERETTE A SOUDER PN 10/16 - ACIER
- D** VORSCHWEISSFESTFLANSCH Typ 11B PN 10/16 - STAHL
- I** FLANGIA FISSA TIPO 11B CON COLLARE A SILDARE DI TESTA-CON GRADINO PN 10/16 - ACCIAIO
- E** BRIDA FIJA TIPO 11B CUELLO PARA SOLDAR PN 10/16 - ACERO
- SV** FAST FLÅNS TYP 11B PN 10/16 - STÅL
- NO** FAST FLENS TYPE 11B PN 10/16 - KARBONSTÅL
- DK** FAST FLANGE TYPE 11B PN 10/16 - STÅL
- FI** KIINTOLAIPPA HITSATTAVALLA KAULUKSELLA TYYPPI 11B. LAIPPA PN 10/16- TERÄS

FIXE FLANGE TYPE 11B WELDING NECK-RAISED FACE PN 10/16 - STAINLESS STEEL 316L..... 12

- FR** BRIDE FIXE TYPE 11B A COLLERETTE A SOUDER PN 10/16 - INOX 316L
- D** VORSCHWEISSFESTFLANSCH Typ 11B PN 10/16 - EDELSTAHL 1.4404 (AISI 316L)
- I** FLANGIA FISSA TIPO 11B CON COLLARE A SILDARE DI TESTA-CON GRADINO PN 10/16 - INOX 316L
- E** BRIDA FIJA TIPO 11B CUELLO PARA SOLDAR PN 10/16 - INOX 316L
- SV** FAST FLÅNS TYP 11B PN 10/16 - SYRAFAST STÅL 316L
- NO** FAST FLENS TYPE 11B PN 10/16 - SYREFAST STÅL 316L
- DK** FAST FLANGE TYPE 11B PN 10/16 - RUSTFRIT STÅL 316L
- FI** KIINTOLAIPPA HITSATTAVALLA KAULUKSELLA TYYPPI 11B. LAIPPA PN 10/16- TERÄS 316L

SWIVEL FLANGE PN 10/16 - STEEL 13

- FR** BRIDE TOURNANTE PN 10/16 - ACIER
- D** LOSFLANSCH PN 10/16 - STAHL
- I** FLANGIA GIREVOLE PN 10/16 - ACCIAIO
- E** BRIDA GIRATORIA PN 10/16 - ACERO
- SV** RÖRLIG FLÅNS PN10/16 - STÅL
- NO** SVIVELFLENS PN 10/16 - KARBONSTÅL
- DK** SVIVEL FLANGE PN 10/16 - STÅL
- FI** IRTOLAIPPA TERÄSTÄ LAIPPA PN 10/16

SWIVEL FLANGE PN 10/16 - STAINLESS STEEL 316L..... 13

- FR** BRIDE TOURNANTE PN 10/16 - INOX 316L
- D** LOSFLANSCH PN 10/16 - EDELSTAHL 1.4404 (AISI 316L)
- I** FLANGIA GIREVOLE PN 10/16 - INOX 316L
- E** BRIDA GIRATORIA PN 10/16 - INOX 316L
- SV** RÖRLIG FLÅNS PN 10/16 - SYRAFAST STÅL 316L
- NO** SVIVELFLENS PN 10/16 - SYREFAST STÅL 316L
- DK** SVIVEL FLANGE PN 10/16 - RUSTFRIT STÅL 316L
- FI** IRTOLAIPPA PN 10/16 HAPONKESTÄVÄ TERÄS 316L

SWIVEL FLANGE TYPE 15A LAP JOINT ASA 150 - STEEL 14

- FR** BRIDE TOURNANTE TYPE 15A LJ ASA 150 - ACIER
- D** LOSFLANSCH Typ 15A ASA 150 - STAHL
- I** FLANGIA GIREVOLE TIPO 15A LJ ASA 150 - ACCIAIO
- E** BRIDA GIRATORIA TIPO 15A LJ ASA 150 - ACERO
- SV** RÖRLIG FLÅNS TYP 15A LJ ASA 150 - STÅL
- NO** SVIVELFLENS TYPE 15A LJ ASA 150 - KARBONSTÅL
- DK** SVIVEL FLANGE TYPE 15A LJ ASA 150 - STÅL
- FI** IRTOLAIPPA TYYPPI 15A ASA 150 LBS TERÄS

SWIVEL FLANGE TYPE 15A LAP JOINT ASA 150 - STAINLESS STEEL 316L 14

- FR** BRIDE TOURNANTE TYPE 15A LJ ASA 150 - INOX 316L
- D** LOSFLANSCH Typ 15A ASA 150 - EDELSTAHL 1.4404 (AISI 316L)
- I** FLANGIA GIREVOLE TIPO 15A LJ ASA 150 - INOX 316L
- E** BRIDA GIRATORIA TIPO 15A LJ ASA 150 - INOX 316L
- SV** RÖRLIG FLÅNS TYP 15A LJ ASA 150 - SYRAFAST STÅL 316L
- NO** SVIVELFLENS TYPE 15A LJ ASA 150 - SYREFAST STÅL 316L
- DK** SVIVEL FLANGE TYPE 15A LJ ASA 150 - RUSTFRIT STÅL 316L
- FI** IRTOLAIPPA TYYPPI 15A ASA 150 LBS HAPONKESTÄVÄ TERÄS 316L

FLANGE LIGHT SUPPORT FLARED COLLAR ISO PN 10/16 - STAINLESS STEEL 316L..... 16

- FR** COLLET MINCE EMBOUTI ISO PN 10/16 A SOUDER - INOX 316L
- D** LEICHTER BÖRDELRING ISO PN 10/16 - EDELSTAHL 1.4404 (AISI 316L)
- I** COLLETTA IMBUTITO ISO PN 10/16 A SILDARE - INOX 316L
- E** CUELLO EMBUTIDO ISO PN 10/16 PARA SOLDAR - INOX 316L
- SV** FLÅNSKRAGE LÅTT UTFÖRANDE STÖDER ISO PN 10/16 - SYRAFAST STÅL 316L
- NO** SVEISEKRAGE ISO PN 10/16 - SYREFAST STÅL 316L
- DK** GLÅT FLANGE LET UTFØRELSE ISO PN 10/16 - RUSTFRIT STÅL 316L
- FI** IRTOLAIPAN KAULUS PN 10/16 HAPONKESTÄVÄÄ TERÄSTÄ 316L

FLANGE HEAVY SUPPORT COLLAR TYPE 32 PN 10/16 - STAINLESS STEEL 316L	16
FR COLLET EPAIS TYPE 32 PN 10/16 A SOUDER - INOX 316L	
D SCHWERER BÖRDELRING TYP 32 PN10/16 - EDELSTAHL 1.4404 (AISI 316L)	
I COLLETTI TIPO 32 PN 10/16 A SILDARE - INOX 316L	
E CUELLO TIPO 32 PN 10/16 PARA SOLDAR - INOX 316L	
SV FLÄNS KRAFTIGT UTFÖRANDE STÖDER TYP 32 PN 10/16 - SYRAFAST STÅL 316L	
NO SVEISEKRAVE KRAFTIG - TYPE 32 PN 10/16 - SYREFAST STÅL 316L	
DK FLANGE SVÆR UDFØRELSE TYPE 32 PN 10/16 - RUSTFRIT STÅL 316L	
FI IRTOLAIPAN KAULUS PN 10/16 HAPONKESTÄVÄÄ TERÄSTÄ 316L	
ANSI SCH.10S - STUB END TYPE C - STAINLESS STEEL 316L	16
FR COLLET STUB END TYPE C - ANSI SCH.10S - INOX 316L	
D BÖRDEL MIT SCHWEISSSTUTZEN TYP C - EDELSTAHL 1.4404 (AISI 316L)	
I COLLETTI STUB END TIPO C - ANSI SCH.10S - INOX 316L	
E CUELLO STUB END TIPO C - ANSI SCH.10S - INOX 316L	
SV KORT ANSLUTNING TYP C - ANSI SCH.10S - SYRAFAST STÅL 316L	
NO KRAVE ENDE TYPE C - ANSI SCH.10S - SYREFAST STÅL 316L	
DK SLANGESTUDS TYPE C - ANSI SCH.10S - RUSTFRIT STÅL 316L	
FI ANSI LAIPPA TYYPPI C HAPONKESTÄVÄ TERÄS 316L	
MALE BSPT HEXAGONAL - STEEL	18
FR MALE GAZ HEXA - ACIER	
D AUSSENGEWINDE MIT SECHSKANT BSPT - STAHL	
I MASCHIO BSPT ESAGONALE - ACCIAIO	
E MACHO BSPT HEXAGONAL - ACERO	
SV UTVÄNDIG RÖRGÅNGA MED SEKKANT - STÅL	
NO MALE BSPT MED SEKKANT - KARBONSTÅL	
DK HANPART BSPT HEKSAGONAL - STÅL	
FI ULKOKIERRELIIITIN BSP KIERRE AVAINVÄLILLÄ TERÄS	
MALE BSPT HEXAGONAL - STAINLESS STEEL 316L	18
FR MALE GAZ HEXA - INOX 316L	
D AUSSENGEWINDE MIT SECHSKANT BSPT - EDELSTAHL 1.4404 (AISI 316L)	
I MASCHIO BSPT ESAGONALE - INOX 316L	
E MACHO BSPT HEXAGONAL - INOX 316L	
SV UTVÄNDIG RÖRGÅNGA MED SEKKANT - SYRAFAST STÅL 316L	
NO MALE BSPT MED SEKKANT - SYREFAST STÅL 316L	
DK HANPART BSPT HEKSAGONAL - RUSTFRIT STÅL 316L	
FI ULKOKIERRELIIITIN BSP KIERRE AVAINVÄLILLÄ HAPONTERÄS 316L	
MALE BSPT PIPE - STAINLESS STEEL 316L	18
FR MALE GAZ BOBINE - INOX 316L	
D AUSSENGEWINDE BSPT - EDELSTAHL 1.4404 (AISI 316L)	
I MASCHIO BSPT BOBINA - INOX 316L	
E MACHO BSPT CILINDRICO - INOX 316L	
SV UTVÄNDIG RÖRGÅNGA - SYRAFAST STÅL 316L	
NO MALE BSPT GLATT - SYREFAST STÅL 316L	
DK HANPART BSPT RØR - RUSTFRIT STÅL 316L	
FI ULKOKIERRELIIITIN BSP KIERRE AVAINVÄLILLÄ HAPONKESTÄVÄ TERÄS 316L	
STANDPIPE FOR WELDING FLANGE - STAINLESS STEEL 316L	19
FR TUBE LISSE A SOUDER BRIDE - INOX 316L	
D ROHRSTUTZEN FÜR ANSCHWEISSFLANSCH - EDELSTAHL 1.4404 (AISI 316L)	
I TUBO LISCIÒ PER SILDARE LE FLANGE - INOX 316L	
E TUBO PARA SOLDAR BRIDAS - INOX 316L	
SV RÖRSTUDS FÖR SVETSFLÄNS - SYRAFAST STÅL 316L	
NO RØRSTUSS FOR SVEIS - SYREFAST STÅL 316L	
DK SVEJSERØRSTUDS - RUSTFRIT STÅL 316L	
FI PUTKIPÄÄTE HITSATTAVALLE LAIPALLE- HAPONKESTÄVÄ	
SWIVEL FEMALE BSP - STEEL	19
FR FEMELLE TOURNANTE BSP - ACIER	
D ÜBERWURFMUTTER BSP - STAHL	
I FEMMINA GIREVOLE BSP - ACCIAIO	
E HEMBRA GIRATORIA BSP - ACERO	
SV INVÄNDIGT RÖRLIG RÖRGÅNGA - STÅL	
NO FEMALE BSP SVIVEL - KARBONSTÅL	
DK HUNPART SVIVEL BSP - STÅL	
FI PYÖRIVÄ SISÄKIERRELIIITIN TERÄS	
SWIVEL FEMALE BSP - STAINLESS STEEL 316L	19
FR FEMELLE TOURNANTE BSP - INOX 316L	
D ÜBERWURFMUTTER BSP - EDELSTAHL 1.4404 (AISI 316L)	
I FEMMINA GIREVOLE BSP - INOX 316L	
E HEMBRA GIRATORIA BSP - INOX 316L	
SV INVÄNDIGT RÖRLIG RÖRGÅNGA - SYRAFAST STÅL 316L	
NO FEMALE BSP SVIVEL - SYREFAST STÅL 316L	
DK HUNPART SVIVEL BSP - RUSTFRIT STÅL 316L	
FI PYÖRIVÄ SISÄKIERRELIIITIN HAPONKESTÄVÄ TERÄS 316L	
UNION 3P COUPLING - BUTT WELD END / FEMALE BSP - STAINLESS STEEL 316L	20
FR RACCORD UNION 3P LISSE - FEMELLE BSP - INOX 316L	
D VERSCHRAUBUNG KONISCH DICHTEND MIT INNENGEWINDE BSPT - EDELSTAHL 1.4404 (AISI 316L)	
I RACCORDO UNIONE 3P A SILDARE - FEMMINA BSP - INOX 316L	
E CONECTOR 3P LISO - HEMBRA BSP - INOX 316L	
SV UNIONSOPPLING PLAN - SVETSANSLUTNING - INVÄNDIG BSP - SYRAFAST STÅL 316L	
NO UNION - SVEIESTUSS - BSP FEMALE SYREFAST 316L	
DK UNION 3P KOBLING - GLAT SVEJS - HUNPART BSP - RUSTFRIT STÅL 316L	
FI HITSATTAVA LÄHTÖLIITIN BSP SISÄKIERRE HAPONKESTÄVÄ 316L	
UNION 3P COUPLING - BUTT WELD END / MALE BSPT - STAINLESS STEEL 316L	20
FR RACCORD UNION 3P LISSE - MALE BSPT - INOX 316L	
D VERSCHRAUBUNG KONISCH DICHTEND MIT AUSSENGEWINDE BSPT - EDELSTAHL 1.4404 (AISI 316L)	
I RACCORDO UNIONE 3P A SILDARE - MASCHIO BSPT - INOX 316L	
E CONECTOR 3P LISO - MACHO BSPT - INOX 316L	
SV UNIONSOPPLING PLAN - SVETSANSLUTNING - UTVÄNDIG BSPT - SYRAFAST STÅL 316L	
NO UNION - SVEIESTUSS - BSPT MALE SYREFAST 316L	
DK UNION 3P KOBLING - GLAT SVEJS - HANPART BSPT - RUSTFRIT STÅL 316L	
FI HITSATTAVA LÄHTÖLIITIN BSP ULKOKIERRE HAPONKESTÄVÄ 316L	

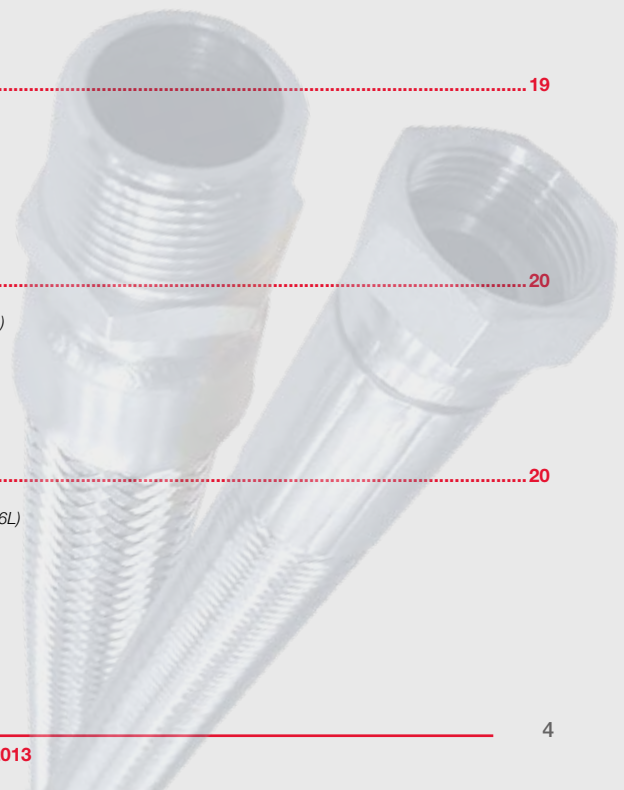



- TUYAU (FR)
- SCHLAUCH (D)
- TUBO (I)
- MANGUERA (E)
- SLANG (SV)
- SLANGE (NO)
- SLANGE (DK)
- LETKU (FI)

ESSOOTH

99DMM

STAINLESS STEEL HOSE - PARALLEL CORRUGATION - AISI 316L WITH 1 BRAID AISI 304

- (FR) FLEXIBLE INOX - ONDE PARALLELE - AISI 316L AVEC 1 TRESSE AISI 304
 (D) EDELSTAHL-RINGWELLSCHLAUCH - NORMALE WELLUNG - 1.4404 (AISI 316L) MIT UMFLECHTUNG AUS 1.4301 (AISI304)
 (I) TUBO ACCIAIO INOX - ONDULAZIONE PARALLELA - AISI 316L CON 1 TRECCIA AISI 304
 (E) TUBO DE ACERO INOX - CORRUGACION PARALELA - AISI 316L CON UNA TRENZA AISI 304
 (SV) ROSTFRI STÅLSLANG, PARALLELLVECKAD. AISI316L (SS2353) MED ROSTFRI FLÅTA AISI 304 (SS2333)
 (NO) RUSTFRI STÅLSLANGE - PARALLELLKORRUGERTE - AISI 316L MED 1 KRYSSFLETNING I AISI 304
 (DK) RUSTFRI STÅLSLANGE - PARALLEL KORRUGERET - AISI 316L MED 1 STÅLFLET I AISI 304
 (FI) RUOSTUMATON KOKOMETALLILETKU-TIHEÄ POIMUINEN RAKENNE PÄÄLLYS AISI 316L PUNOS AISI 304

Hose: AISI 316L-DIN 1.4404-Z2CN17-12

Braid: AISI 304-DIN 1.4301-Z6CN18-09

Safety factor: 4:1

Temperature: -270 °C +700 °C

Tolerances: ± 0,2 mm: DN 6 ÷ DN 32
 ± 0,3 mm: DN 40 ÷ DN 200



Item Code	Part Number									
		DN	mm	inch	without braid	with 1 braid		dynamic	static	
2600361	99DMM006110000	6	6,1	1/4	9,6	10,6	100	100	25	0,140
2600401	99DMM010180000	10	10,0	3/8	14,3	15,4	90	150	40	0,190
2600402	99DMM013210000	12	12,2	1/2	16,7	17,8	80	200	50	0,210
2600362	99DMM016230000	16	16,2	5/8	21,6	22,8	70	200	50	0,410
2600403	99DMM020300000	20	20,3	3/4	26,8	28,0	64	200	70	0,480
2600404	99DMM025380000	25	25,4	1	32,2	33,7	50	200	90	0,650
2600363	99DMM032430000	32	34,3	1 1/4	41,1	43,0	40	250	110	0,760
2600405	99DMM038540000	40	40,0	1 1/2	49,8	52,5	30	250	130	1,050
2600406	99DMM051680000	50	50,2	2	65,0	67,2	28	350	175	1,440
2600407	99DMM063880000	65	65,4	2 1/2	80,8	83,0	24	410	200	1,689
2600408	99DMM075000000	80	79,9	3	95,0	97,0	18	450	205	2,084
2600409	99DMM100000000	100	100	4	116,7	119,0	16	560	230	3,749
2600364	99DMM125530000	125	125	5	149,0	152,5	12	660	280	4,930
2600365	99DMM150780000	150	150	6	174,9	177,5	10	815	320	5,837
2600336	99DMM200280000	200	198	8	225,0	228,0	8	1015	435	8,762

All these data are based for a temperature of 20°C.

99EMM

STAINLESS STEEL HOSE - PARALLEL NARROW CORRUGATION - AISI 316L WITH 1 BRAID AISI 304

- (FR) FLEXIBLE INOX - ONDE PARALLELE RAPPROCHEE - AISI 316L AVEC 1 TRESSE AISI 304
- (D) EDELSTAHL-RINGWELLSCHLAUCH - ENGE WELLUNG - 1.4404 (AISI 316L) MIT UMFLECHTUNG AUS 1.4301 (AISI304)
- (I) TUBO ACCIAIO INOX - ONDULAZIONE PARALLELA RAVVICINATA - AISI 316L CON 1 TRECCIA AISI 304
- (E) TUBO DE ACERO INOX - CORRUGACION PARALELA COMPRIMIDA - AISI 316L CON UNA TRENZA AISI 304
- (SV) ROSTFRI STÅLSLANG. PARALLELL TÄTVECKAD. AISI316L (SS2353) MED ROSTFRI FLÄTA AISI304 (SS2333)
- (NO) SYREFAST STÅLSLANGE - PARALLELL- OG TETTKORRUGERT - AISI 316L MED 1 KRYSSFLETNING I AISI 304
- (DK) RUSTFRI STÅLSLANGE - PARALLEL TÆT KORRUGERET - AISI 316L MED 1 STÅLFLET I AISI 304
- (FI) RUOSTUMATON KOKOMETALLILETKU- TIHEA POIMUINEN PÄÄLLYS AISI 316L PUNOS AISI 304

Hose: AISI 316L-DIN 1.4404-Z2CN17-12 (DN 10 ÷ DN 20)

AISI 316TI-1.4571 (DN 25 ÷ DN 150)

Braid: AISI 304-DIN 1.4301-Z6CN18-09

Safety factor: 3:1

Temperature: -270 °C +600 °C



Item Code	Part Number	↔				↔		🕒	📐		🏠
		DN	mm	tol±mm	inch	with 1 braid			dynamic	static	
						mm	tol±mm	bar	mm	mm	kg/m
2600015	99EMM010180000	10	10,2	0,2	3/8	18	0,4	165	100	29	0,30
2600142	99EMM013210000	12	12,9	0,2	1/2	21,3	0,4	110	120	34	0,38
2600017	99EMM020300000	20	19,8	0,2	3/4	29,1	0,4	80	160	53	0,52
2600088	99EMM025380000	25	25,1	0,5	1	35,3	0,7	50	155	64	0,73
2600018	99EMM032460000	32	31,7	0,5	1 1/4	44,9	0,7	40	180	79	1,15
2600064	99EMM038550000	40	40,7	0,5	1 1/2	54,9	0,7	45	200	98	1,55
2600034	99EMM051680000	50	49,9	0,5	2	65,7	0,7	38	280	120	1,63
2600019	99EMM063890000	65	65	0,6	2 1/2	82,9	0,8	26	275	150	2,35
2600020	99EMM076000000	80	80	0,7	3	100,8	0,9	29	360	180	3,91
2600143	99EMM102280000	100	100,1	0,7	4	122,8	0,9	20	450	218	4,46
2600086	99EMM127550000	125	124,9	0,8	5	150,6	1,0	20	720	315	7,09
2600144	99EMM152800000	150	150,4	0,9	6	178,2	1,1	23	900	360	9,69

All these data are based for a temperature of 20°C.

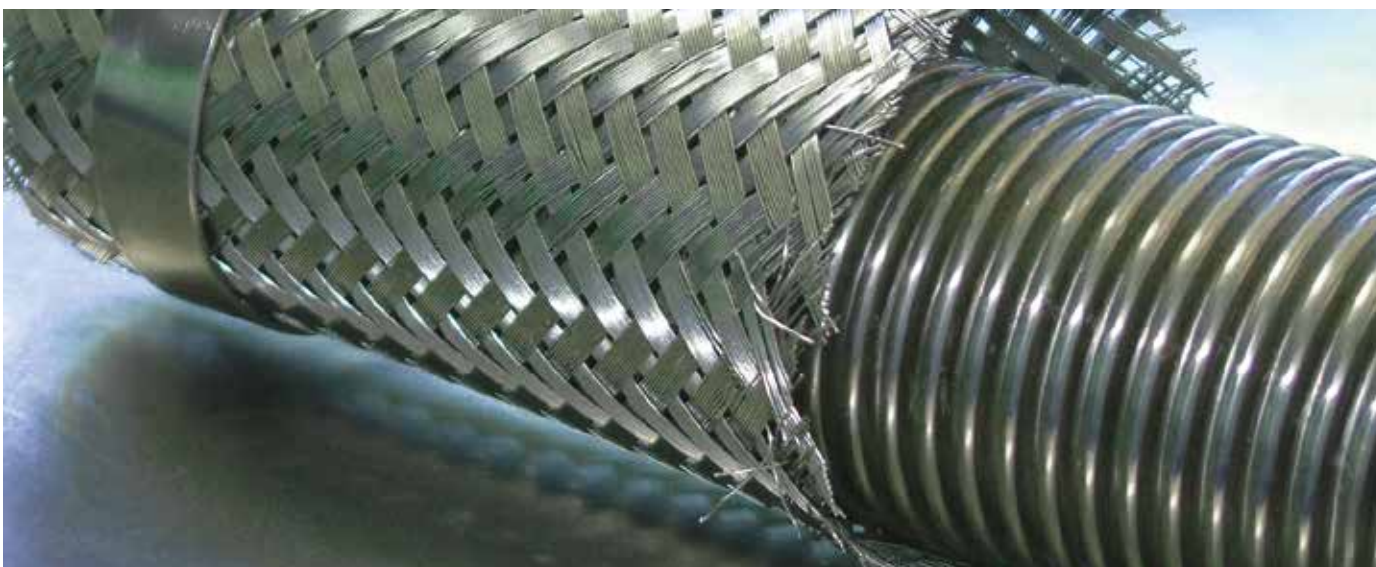



- BAGUE DE SOUDURE (FR)
- SCHWEISSRING (D)
- ANELLO A SALDARE (I)
- CASQUILLO SOLDABLE (E)
- SVETSRING (SV)
- SVEISERING (NO)
- SVEJSERING (DK)
- HOLKKI (FI)



WELDING RING

WELDING RING - STAINLESS STEEL AISI 304

- Ⓡ BAGUE DE SOUDURE - INOX 304
- Ⓡ SCHWEISSRING - EDELSTAHL 1.4301 (AISI304)
- Ⓡ ANELLO A SALDARE - INOX 304
- Ⓡ CASQUILLO SOLDABLE - INOX 304
- Ⓡ SVETS RING - SYRAFAST STÅL 304
- Ⓡ SVEISERING - SYREFAST STÅL 304
- Ⓡ SVEJSERING - RUSTFRIT STÅL 304
- Ⓡ HOLKKI - AISI 304



Item Code	Part Number	DN	DN inch
2301047	I2099A-006	6	1/4
2300859	I2099A-010	10	3/8
2300860	I2099A-013	12	1/2
2300861	I2099A-016	16	5/8
2300862	I2099A-019	20	3/4
2300863	I2099A-025	25	1
2300864	I2099A-032	32	1 1/4
2300865	I2099A-038	40	1 1/2
2300866	I2099A-050	50	2
2300867	I2099A-063	65	2 1/2
2300868	I2099A-076	80	3
2301926	I2099E-100	100	4
2301928	I2099E-125	125	5
2301930	I2099E-150	150	6
2304558	I2099A-200	200	8

BRIDES (FR)
FLANSCHEN (D)
FLANGE (I)
BRIDAS (E)
FLÄNSAR (SV)
FLENSER (NO)
FLANGER (DK)
LAIPAT (FI)



FLANGES

FIXE FLANGE TYPE 11B WELDING NECK-RAISED FACE PN 10/16 - STEEL

- (FR) BRIDE FIXE TYPE 11B A COLLERETTE A SOUDER PN 10/16 - ACIER
- (D) VORSCHWEISSFESTFLANSCH TYP 11B PN 10/16 - STAHL
- (I) FLANGIA FISSA TIPO 11B CON COLLARE A SILDARE DI TESTA - CON GRADINO PN 10/16 - ACCIAIO
- (E) BRIDA FIJA TIPO 11B CUELLO PARA SOLDAR PN 10/16 - ACERO
- (SV) FAST FLÄNS TYP 11B PN 10/16 - STÅL
- (NO) FAST FLENS TYPE 11B PN 10/16 - KARBONSTÅL
- (DK) FAST FLANGE TYPE 11B PN 10/16 - STÅL
- (FI) KIINTOLAIPPA HITSATAVALLA KAULUKSELLA TYYPPI 11B. LAIPPA PN 10/16- TERÄS



Item Code	Part Number	DN	DN inch	H mm	E mm	D mm	Ø tube mm	b mm	n° hole	O mm	c mm	Weight kg
2301236	I0WBD6B0-020	20	3/4	38	58	105	26,9	16	4	14	75	1,00
2301237	I0WBD6B0-025	25	1	38	68	115	33,7	16	4	14	85	1,20
2301238	I0WBD6B0-032	32	1 1/4	40	78	140	42,4	16	4	18	100	1,75
2301239	I0WBD6B0-040	40	1 1/2	42	88	150	48,3	16	4	18	110	1,85
2301240	I0WBD6B0-050	50	2	45	102	165	60,3	18	4	18	125	2,55
2301241	I0WBD6B0-065	65	2 1/2	45	122	185	76,1	18	4	18	145	3,10
2301242	I0WBD6B0-080	80	3	50	138	200	88,9	20	8	18	160	4,00
2301243	I0WBD6B0-100	100	4	52	158	220	114,3	20	8	18	180	4,55
2301244	I0WBD6B0-125	125	5	55	188	250	139,7	22	8	18	210	6,20
2301245	I0WBD6B0-150	150	6	55	212	285	168,3	22	8	22	240	7,80

FIXE FLANGE TYPE 11B WELDING NECK-RAISED FACE PN 10/16 - STAINLESS STEEL 316L

- (FR) BRIDE FIXE TYPE 11B A COLLERETTE A SOUDER PN 10/16 - INOX 316L
- (D) VORSCHWEISSFESTFLANSCH Typ 11B PN 10/16 - EDELSTAHL 1.4404 (AISI 316L)
- (I) FLANGIA FISSA TIPO 11B CON COLLARE A SILDARE DI TESTA - CON GRADINO PN 10/16 - INOX 316L
- (E) BRIDA FIJA TIPO 11B CUELLO PARA SOLDAR PN 10/16 - INOX 316L
- (SV) FAST FLÄNS TYP 11B PN 10/16 - SYRAFAST STÅL 316L
- (NO) FAST FLENS TYPE 11B PN 10/16 - SYREFAST STÅL 316L
- (DK) FAST FLANGE TYPE 11B PN 10/16 - RUSTFRIT STÅL 316L
- (FI) KIINTOLAIPPA HITSATAVALLA KAULUKSELLA TYYPPI 11B. LAIPPA PN 10/16- TERÄS 316L



Item Code	Part Number	DN	DN inch	H mm	E mm	D mm	Ø Tube mm	b mm	n° hole	O mm	c mm	Weight kg
2301667	I3WBD6B0-015	15	1/2	35	45	95	21,3	14	4	14	65	0,70
2301525	I3WBD6B0-020	20	3/4	38	58	105	26,9	16	4	14	75	1,00
2301310	I3WBD6B0-025	25	1	38	68	115	33,7	16	4	14	85	1,20
2301311	I3WBD6B0-032	32	1 1/4	40	78	140	42,4	16	4	18	100	1,75
2301312	I3WBD6B0-038	40	1 1/2	42	88	150	48,3	16	4	18	110	1,85
2301313	I3WBD6B0-050	50	2	45	102	165	60,3	18	4	18	125	2,55
2301314	I3WBD6B0-065	65	2 1/2	45	122	185	76,1	18	4	18	145	3,10
2301990	I3WBD6B0-080	80	3	50	138	200	88,9	20	8	18	160	4,00
2301315	I3WBD6B0-100	100	4	52	158	220	114,3	20	8	18	180	4,55
2305773	I3WBD6B0-125	125	5	55	188	250	139,7	22	8	18	210	6,20
2301361	I3WBD6B0-150	150	6	55	212	285	168,3	22	8	22	240	7,80

SWIVEL FLANGE PN 10/16 - STEEL

- (FR) BRIDE TOURNANTE PN 10/16 - ACIER
- (D) LOSFLANSCH PN 10/16 - STAHL
- (I) FLANGIA GIREVOLE PN 10/16 - ACCIAIO
- (E) BRIDA GIRATORIA PN 10/16 - ACERO
- (SV) RÖRLIG FLÄNS PN10/16 - STÅL
- (NO) SVIVELFLENS PN 10/16 - KARBONSTÅL
- (DK) SVIVEL FLANGE PN 10/16 - STÅL
- (FI) IRTOLAIPPA TERÄSTÄ LAIPPA PN 10/16

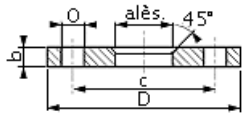

Item Code	Part Number	DN	DN inch	D mm	Ales. mm	b mm	n° hole	O mm	c mm	Weight kg
2301368	I1WBD2A0-015	15	1/2	95	25	14	4	14	65	0,67
2301369	I1WBD2A0-020	20	3/4	105	30	16	4	14	75	0,95
2301370	I1WBD2A0-025	25	1	115	36	16	4	14	85	1,10
2301371	I1WBD2A0-032	32	1 1/4	140	46	16	4	18	100	1,62
2301372	I1WBD2A0-040	40	1 1/2	150	54	16	4	18	110	1,85
2301373	I1WBD2A0-050	50	2	165	65	16	4	18	125	2,45
2301374	I1WBD2A0-065	65	2 1/2	185	81	18	4	18	145	3,00
2301375	I1WBD2A0-080	80	3	200	94	18	8	18	160	3,95
2301376	I1WBD2A0-100	100	4	220	119	18	8	18	180	4,40
2301377	I1WBD2A0-125	125	5	250	145	18	8	18	210	5,90
2301378	I1WBD2A0-150	150	6	285	173	18	8	22	240	7,10

SWIVEL FLANGE PN 10/16 - STAINLESS STEEL 316L

- (FR) BRIDE TOURNANTE PN 10/16 - INOX 316L
- (D) LOSFLANSCH PN 10/16 - EDELSTAHL 1.4404 (AISI 316L)
- (I) FLANGIA GIREVOLE PN 10/16 - INOX 316L
- (E) BRIDA GIRATORIA PN 10/16 - INOX 316L
- (SV) RÖRLIG FLÄNS PN 10/16 - SYRAFAST STÅL 316L
- (NO) SVIVELFLENS PN 10/16 - SYREFAST STÅL 316L
- (DK) SVIVEL FLANGE PN 10/16 - RUSTFRIT STÅL 316L
- (FI) IRTOLAIPPA PN 10/16 HAPONKESTÄVÄ TERÄS 316L

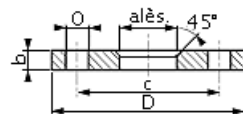

Item Code	Part Number	DN	DN inch	D mm	Ales. mm	b mm	n° hole	O mm	c mm	Weight kg
2300116	I3WBD2A0-015	15	1/2	95	24	14	4	14	65	0,67
2300117	I3WBD2A0-020	20	3/4	105	30	16	4	14	75	0,95
2300118	I3WBD2A0-025	25	1	115	36	16	4	14	85	1,10
2300079	I3WBD2A0-032	32	1 1/4	140	46	16	4	18	100	1,62
2300080	I3WBD2A0-040	40	1 1/2	150	54	16	4	18	110	1,85
2300081	I3WBD2A0-050	50	2	165	65	16	4	18	125	2,45
2300082	I3WBD2A0-065	65	2 1/2	185	81	18	4	18	145	3,00
2300084	I3WBD2A0-080	80	3	200	94	18	8	18	160	3,95
2300085	I3WBD2A0-100	100	4	220	119	18	8	18	180	4,40
2301131	I3WBD2A0-125	125	5	250	145	18	8	18	210	5,90
2300104	I3WBD2A0-150	150	6	285	173	18	8	22	240	7,10

SWIVEL FLANGE TYPE 15A LAP JOINT ASA 150 - STEEL

- (FR) BRIDE TOURNANTE TYPE 15A LJ ASA 150 - ACIER
- (D) LOSFLANSCH TYP 15A ASA 150 - STAHL
- (I) FLANGIA GIREVOLE TIPO 15A LJ ASA 150 - ACCIAIO
- (E) BRIDA GIRATORIA TIPO 15A LJ ASA 150 - ACERO
- (SV) RÖRLIG FLÄNS TYP 15A LJ ASA 150 - STÅL
- (NO) SVIVELFLENS TYPE 15A LJ ASA 150 - KARBONSTÅL
- (DK) SVIVEL FLANGE TYPE 15A LJ ASA 150 - STÅL
- (FI) IRTOLAIPPA TYYPPI 15A ASA 150 LBS TERÄS

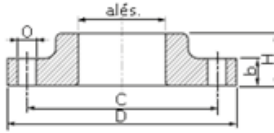

Item Code	Part Number	DN inch	D mm	Ales. mm	b mm	n° hole	O mm	C mm	Weight kg
2302390	I1WBE9A0-015	1/2	89	22,9	11,2	4	15,8	60,3	0,50
2301911	I1WBE9A0-020	3/4	99	28,2	12,7	4	15,8	69,8	0,60
2302391	I1WBE9A0-025	1	108	35,0	14,3	4	15,8	79,4	0,80
2302392	I1WBE9A0-032	1 1/4	117	43,7	15,9	4	15,8	88,9	1,10
2302393	I1WBE9A0-040	1 1/2	127	50,0	17,5	4	15,8	98,4	1,40
2301912	I1WBE9A0-050	2	152	62,5	19,1	4	19,0	120,6	2,30
2302394	I1WBE9A0-065	2 1/2	178	75,4	22,3	4	19,0	139,7	3,20
2305709	I1WBE9A0-080	3	190	91,4	23,9	4	19,0	152,4	3,60
2305710	I1WBE9A0-102	4	229	116,4	23,9	8	19,0	190,5	5,80
2302062	I1WBE9A0-125	5	254	144,5	23,9	8	22,2	215,9	6,30
2302397	I1WBE9A0-152	6	279	171,4	25,4	8	22,2	241,3	8,60

SWIVEL FLANGE TYPE 15A LAP JOINT ASA 150 - STAINLESS STEEL 316L

- (FR) BRIDE TOURNANTE TYPE 15A LJ ASA 150 - INOX 316L
- (D) LOSFLANSCH TYP 15A ASA 150 - EDELSTAHL 1.4404 (AISI 316L)
- (I) FLANGIA GIREVOLE TIPO 15A LJ ASA 150 - INOX 316L
- (E) BRIDA GIRATORIA TIPO 15A LJ ASA 150 - INOX 316L
- (SV) RÖRLIG FLÄNS TYP 15 A LJ ASA 150 - SYRAFAST STÅL 316L
- (NO) SVIVELFLENS TYPE 15A LJ ASA 150 - SYREFAST STÅL 316L
- (DK) SVIVEL FLANGE TYPE 15A LJ ASA 150 - RUSTFRIT STÅL 316L
- (FI) IRTOLAIPPA TYYPPI 15A ASA 150 LBS HAPONKESTÄVÄ TERÄS 316L

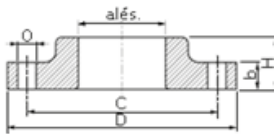

Item Code	Part Number	DN inch	D mm	Ales. mm	b mm	n° hole	O mm	C mm	Weight kg
2302665	I3WBE9A0-015	1/2	89	22,9	11,2	4	15,8	60,3	0,50
2302666	I3WBE9A0-020	3/4	99	28,2	12,7	4	15,8	69,8	0,60
2302667	I3WBE9A0-025	1	108	35,0	14,3	4	15,8	79,4	0,80
2301992	I3WBE9A0-032	1 1/4	117	43,7	15,9	4	15,8	88,9	1,10
2302668	I3WBE9A0-040	1 1/2	127	50,0	17,5	4	15,8	98,4	1,40
2301994	I3WBE9A0-050	2	152	62,5	19,1	4	19,0	120,6	2,30
2302669	I3WBE9A0-065	2 1/2	178	75,4	22,3	4	19,0	139,7	3,20
2302670	I3WBE9A0-080	3	190	91,4	23,9	4	19,0	152,4	3,60
2301996	I3WBE9A0-100	4	229	116,4	23,9	8	19,0	190,5	5,80
2301748	I3WBE9A0-150	6	279	171,4	25,4	8	22,2	241,3	8,60

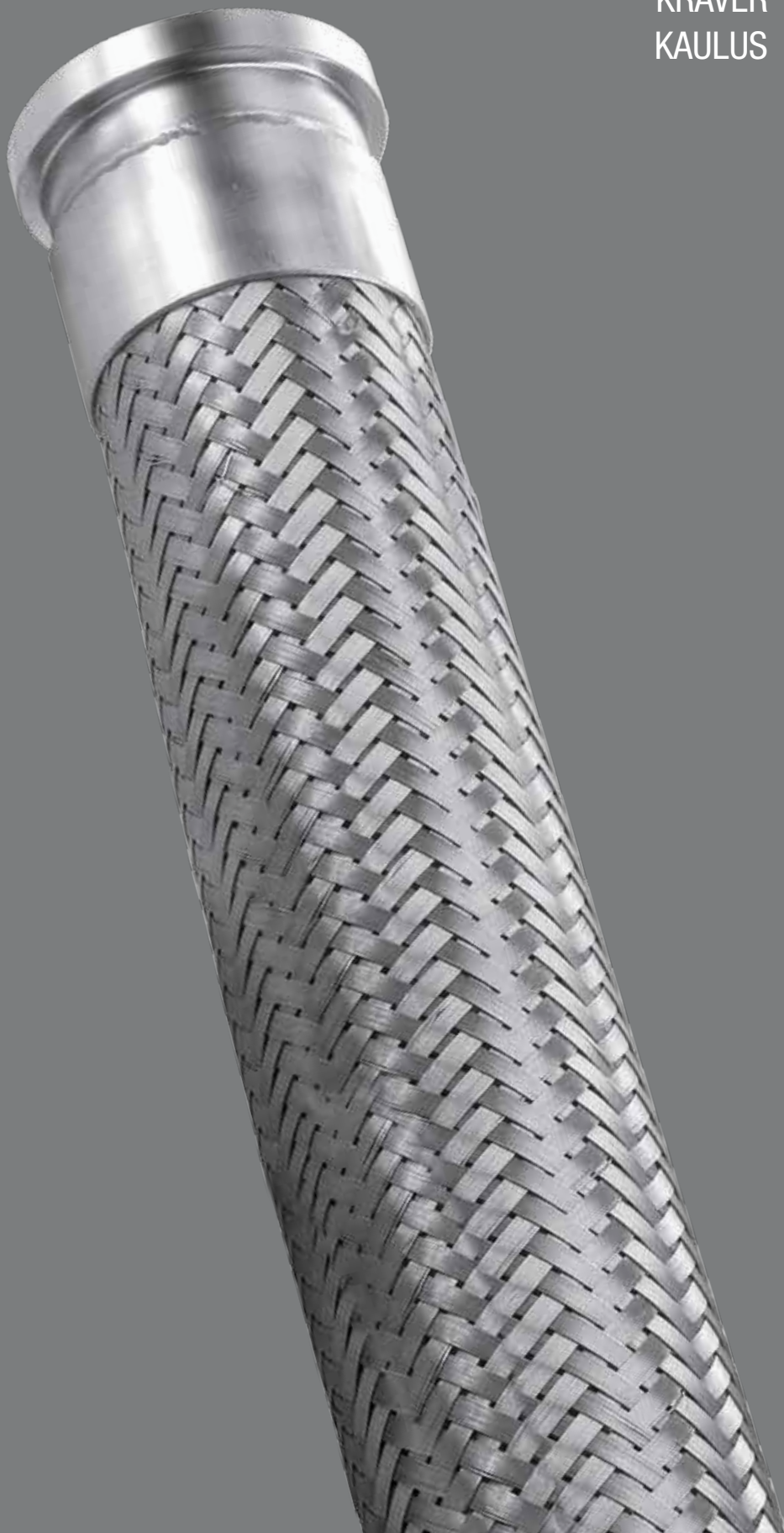

COLLETS (FR)
KRAGEN (D)
COLLETTI (I)
COLLARES (E)
FLÄNS KRAGE (SV)
SVEISEKRAVE (NO)
KRAVER (DK)
KAULUS (FI)

COLLAR

FLANGE LIGHT SUPPORT FLARED COLLAR ISO PN 10/16 - STAINLESS STEEL 316L

- (FR) COLLET MINCE EMBOUTI ISO PN 10/16 A SOUDER - INOX 316L
- (D) LEICHTER BÖRDELRING ISO PN 10/16 - EDELSTAHL 1.4404 (AISI 316L)
- (I) COLLETTO IMBUTITO ISO PN 10/16 A SALDARE - INOX 316L
- (E) CUELLO EMBUTIDO ISO PN 10/16 PARA SOLDAR - INOX 316L
- (SV) FLÄNSKRAGE LÄTT UTFÖRANDE STÖDER ISO PN 10/16 - SYRAFAST STÅL 316L
- (NO) SVEISEKRAVE ISO PN 10/16 - SYREFAST STÅL 316L
- (DK) GLAT FLANGE LET UDFØRELSE ISO PN 10/16 - RUSTFRIT STÅL 316L
- (FI) IRTOLAIPAN KAULUS PN 10/16 HAPONKESTÄVÄÄ TERÄSTÄ 316L

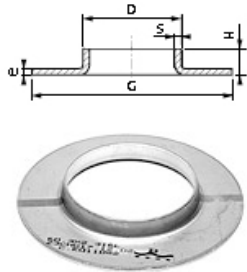

Item Code	Part Number	DN	DN inch	D mm	S mm	e mm	G mm	H mm	Weight kg
2300413	I3BBC440-015	15	1/2	21,3	1,6	2	45	6	0,01
2300414	I3BBC440-020	20	3/4	26,9	1,6	2	58	7	0,04
2300415	I3BBC440-025	25	1	33,7	1,6	2	68	9	0,05
2300416	I3BBC440-032	32	1 1/4	42,4	1,6	2	78	10	0,07
2300417	I3BBC440-040	40	1 1/2	48,3	1,6	2	88	10	0,08
2300418	I3BBC440-050	50	2	60,3	1,6	2	102	12	0,11
2300419	I3BBC440-065	65	2 1/2	76,1	1,6	2	122	12	0,15
2300420	I3BBC440-080	80	3	88,9	2,0	2	138	13	0,19
2300421	I3BBC440-100	100	4	114,3	2,0	2	158	13	0,21
2301130	I3BBC440-125	125	5	139,7	2,0	2	188	14	0,26
2301148	I3BBC440-150	150	6	168,3	2,0	2	212	18	0,34

FLANGE HEAVY SUPPORT COLLAR TYPE 32 PN 10/16 - STAINLESS STEEL 316L

- (FR) COLLET EPAIS TYPE 32 PN 10/16 A SOUDER - INOX 316L
- (D) SCHWERER BÖRDELRING TYP 32 PN10/16 - EDELSTAHL 1.4404 (AISI 316L)
- (I) COLLETTO TIPO 32 PN 10/16 A SALDARE - INOX 316L
- (E) CUELLO TIPO 32 PN 10/16 PARA SOLDAR - INOX 316L
- (SV) FLÄNS KRAFTIGT UTFÖRANDE STÖDER TYP 32 PN 10/16 - SYRAFAST STÅL 316L
- (NO) SVEISEKRAVE KRAFTIG - TYPE 32 PN 10/16 - SYREFAST STÅL 316L
- (DK) FLANGE SVÆR UDFØRELSE TYPE 32 PN 10/16 - RUSTFRIT STÅL 316L
- (FI) IRTOLAIPAN KAULUS PN 10/16 HAPONKESTÄVÄÄ TERÄSTÄ 316L

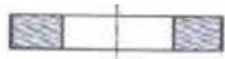

Item Code	Part Number	DN	DN inch
2300424	I3BBD440-025	25	1
2300425	I3BBD440-032	32	1 1/4
2300426	I3BBD440-040	40	1 1/2
2300427	I3BBD440-050	50	2
2300428	I3BBD440-065	65	2 1/2
2300429	I3BBD440-080	80	3
2300430	I3BBD440-100	100	4
2301260	I3BBD440-125	125	5
2301261	I3BBD440-150	150	6

ANSI SCH.10S - STUB END TYPE C - STAINLESS STEEL 316L

- (FR) COLLET STUB END TYPE C - ANSI SCH.10S - INOX 316L
- (D) BÖRDEL MIT SCHWEISSSTUTZEN TYP C - EDELSTAHL 1.4404 (AISI 316L)
- (I) COLLETTO STUB END TIPO C - ANSI SCH.10S - INOX 316L
- (E) CUELLO STUB END TIPO C - ANSI SCH.10S - INOX 316L
- (SV) KORT ANSLUTNING TYP C - ANSI SCH.10S - SYRAFAST STÅL 316L
- (NO) KRAVE ENDE TYPE C - ANSI SCH.10S - SYREFAST STÅL 316L
- (DK) SLANGESTUDS TYPE C - ANSI SCH.10S - RUSTFRIT STÅL 316L
- (FI) ANSI LAIPPA TYYPI C HAPONKESTÄVÄÄ TERÄS 316L

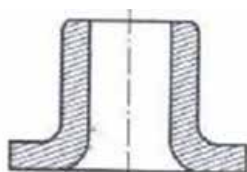

Item Code	Part Number	DN inch
2302657	I3BBE420-015	1/2
2301229	I3BBE420-020	3/4
2301147	I3BBE420-025	1
2301226	I3BBE420-032	1 1/4
2301227	I3BBE420-040	1 1/2
2300973	I3BBE420-050	2
2301228	I3BBE420-065	2 1/2
2300974	I3BBE420-080	3
2301197	I3BBE420-100	4
2302061	I3BBE420-125	5
2302658	I3BBE420-150	6

RACCORDS (FR)
ARMATUREN (D)
RACCORDI (I)
RACORES (E)
KOPPLING (SV)
KUPLINGER (NO)
KOBLINGER (DK)
LIITTIMET (FI)



FEITTINGES

MALE BSPT HEXAGONAL - STEEL

- (FR) MALE GAZ HEXA - ACIER
- (D) AUSSENGEWINDE MIT SECHSKANT BSPT - STAHL
- (I) MASCHIO BSPT ESAGONALE - ACCIAIO
- (E) MACHO BSPT HEXAGONAL - ACERO
- (SV) UTVÄNDIG RÖRGÄNGA MED SEKKANT - STÅL
- (NO) MALE BSPT MED SEKSKANT - KARBONSTÅL
- (DK) HANPART BSPT HEKSAGONAL - STÅL
- (FI) ULKOKIERRELIITIN BSP KIERRE AVAINVÄLILLÄ TERÄS

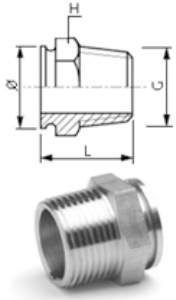

Item Code	Part Number	DN	DN inch	G inch	L mm	Ø mm	H mm	Weight kg
2302242	I0B07100-006013	6	1/4	1/4	20,0	13,5	14	0,010
2301896	I0B07100-010017	10	3/8	3/8	22,5	17,2	19	0,020
2301897	I0B07100-013021	13	1/2	1/2	25,0	21,3	23	0,035
2301898	I0B07100-019027	19	3/4	3/4	31,5	26,9	27	0,060
2301899	I0B07100-025034	25	1	1	36,0	33,7	36	0,110
2301900	I0B07100-032042	32	1 1/4	1 1/4	38,0	42,4	46	0,175
2301901	I0B07100-038049	38	1 1/2	1 1/2	39,0	48,3	50	0,180
2301902	I0B07100-051060	51	2	2	43,0	60,3	65	0,340

MALE BSPT HEXAGONAL - STAINLESS STEEL 316L

- (FR) MALE GAZ HEXA - INOX 316L
- (D) AUSSENGEWINDE MIT SECHSKANT BSPT - EDELSTAHL 1.4404 (AISI 316L)
- (I) MASCHIO BSPT ESAGONALE - INOX 316L
- (E) MACHO BSPT HEXAGONAL - INOX 316L
- (SV) UTVÄNDIG RÖRGÄNGA MED SEKKANT - SYRAFAST STÅL 316L
- (NO) MALE BSPT MED SEKSKANT - SYREFAST STÅL 316L
- (DK) HANPART BSPT HEKSAGONAL - RUSTFRIT STÅL 316L
- (FI) ULKOKIERRELIITIN BSP KIERRE AVAINVÄLILLÄ HAPONTERÄS 316L

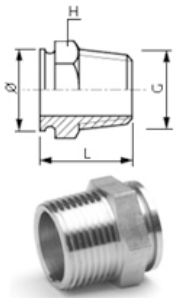

Item Code	Part Number	DN	DN inch	G inch	L mm	Ø mm	H mm	Weight kg
2301959	I3B0710Z-006013	6	1/4	1/4	20,0	13,5	14	0,010
2300431	I3B0710Z-010017	10	3/8	3/8	22,5	17,2	19	0,020
2300432	I3B0710Z-013021	13	1/2	1/2	25,0	21,3	23	0,035
2300433	I3B0710Z-019027	19	3/4	3/4	31,5	26,9	27	0,060
2300434	I3B0710Z-025034	25	1	1	36,0	33,7	36	0,110
2300435	I3B0710Z-032042	32	1 1/4	1 1/4	38,0	42,4	46	0,175
2300436	I3B0710Z-038049	38	1 1/2	1 1/2	39,0	48,3	50	0,180
2301966	I3B0710Z-051060	51	2	2	43,0	60,3	65	0,340

MALE BSPT PIPE - STAINLESS STEEL 316L

- (FR) MALE GAZ BOBINE - INOX 316L
- (D) AUSSENGEWINDE BSPT - EDELSTAHL 1.4404 (AISI 316L)
- (I) MASCHIO BSPT BOBINA - INOX 316L
- (E) MACHO BSPT CILINDRICO - INOX 316L
- (SV) UTVÄNDIG RÖRGÄNGA - SYRAFAST STÅL 316L
- (NO) MALE BSPT GLATT - SYREFAST STÅL 316L
- (DK) HANPART BSPT RØR - RUSTFRIT STÅL 316L
- (FI) ULKOKIERRELIITIN BSP KIERRE AVAINVÄLILLÄ HAPONKESTÄVÄ TERÄS 316L

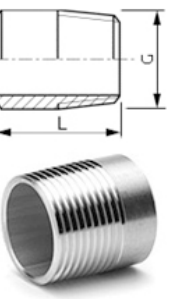

Item Code	Part Number	DN	DN inch	G inch	L mm	Weight kg
2305097	I3B07100-006013	6	1/4	1/4	22	0,010
2300438	I3B07100-010017	10	3/8	3/8	23	0,015
2300439	I3B07100-013021	13	1/2	1/2	27	0,025
2300440	I3B07100-019027	19	3/4	3/4	33	0,040
2300441	I3B07100-025034	25	1	1	35	0,065
2300442	I3B07100-032042	32	1 1/4	1 1/4	36	0,085
2300443	I3B07100-038049	38	1 1/2	1 1/2	41	0,110
2301940	I3B07100-051060	51	2	2	46	0,195
2300445	I3B07100-063076	63	2 1/2	2 1/2	55	0,280
2301941	I3B07100-076090	76	3	3	60	0,560
2301942	I3B07100-102114	102	4	4	80	1,065

STANDPIPE FOR WELDING FLANGE - STAINLESS STEEL 316L

- (FR) TUBE LISSE A SOUDER BRIDE - INOX 316L
- (D) ROHRSTUTZEN FÜR ANSCHWEISSFLANSCH - EDELSTAHL 1.4404 (AISI 316L)
- (I) TUBO LISCIO PER SALDARE LE FLANGE - INOX 316L
- (E) TUBO PARA SOLDAR BRIDAS - INOX 316L
- (SV) RÖRSTUDS FÖR SVETSFLÄNS - SYRAFAST STÅL 316L
- (NO) RØRSTUSS FOR SVEIS - SYREFAST STÅL 316L
- (DK) SVEJSE RØRSTUDS - RUSTFRIT STÅL 316L
- (FI) PUTKIPÄÄTE HITSATTAVALLE LAIPALLE- HAPONKESTÄVÄ



Item Code	Part Number	DN	D inch	L mm
2302650	I3B22100-006010	6	1/4	40
2301974	I3B22100-010017	10	3/8	50
2301975	I3B22100-013021	13	1/2	50
2301976	I3B22100-019027	19	3/4	50
2301977	I3B22100-025034	25	1	50
2301978	I3B22100-032042	32	1 1/4	50
2301980	I3B22100-038049	38	1 1/2	60
2301981	I3B22100-050060	51	2	60
2302651	I3B22100-063076	63	2 1/2	60
2301984	I3B22100-076090	76	3	65
2301987	I3B22100-102114	102	4	75

SWIVEL FEMALE BSP - STEEL

- (FR) FEMELLE TOURNANTE BSP - ACIER
- (D) ÜBERWURFMUTTER BSP - STAHL
- (I) FEMMINA GIREVOLE BSP - ACCIAIO
- (E) HEMBRA GIRATORIA BSP - ACERO
- (SV) INVÄNDIGT RÖRLIG RÖRGÄNGA - STÅL
- (NO) FEMALE BSP SVIVEL - KARBONSTÅL
- (DK) HUNPART SVIVEL BSP - STÅL
- (FI) PYÖRIVÄ SISÄKIERRELIITIN TERÄS

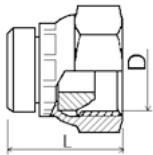

Item Code	Part Number	DN	D inch
2301904	I0B05200-010017	10	3/8
2301905	I0B05200-013021	13	1/2
2301906	I0B05200-019027	19	3/4
2301907	I0B05200-025034	25	1
2301908	I0B05200-032042	32	1 1/4
2301909	I0B05200-038049	38	1 1/2
2301910	I0B05200-051060	51	2

SWIVEL FEMALE BSP - STAINLESS STEEL 316L

- (FR) FEMELLE TOURNANTE BSP - INOX 316L
- (D) ÜBERWURFMUTTER BSP - EDELSTAHL 1.4404 (AISI 316L)
- (I) FEMMINA GIREVOLE BSP - INOX 316L
- (E) HEMBRA GIRATORIA BSP - INOX 316L
- (SV) INVÄNDIGT RÖRLIG RÖRGÄNGA - SYRAFAST STÅL 316L
- (NO) FEMALE BSP SVIVEL - SYREFAST STÅL 316L
- (DK) HUNPART SVIVEL BSP - RUSTFRIT STÅL 316L
- (FI) PYÖRIVÄ SISÄKIERRELIITIN HAPONKESTÄVÄ TERÄS 316L

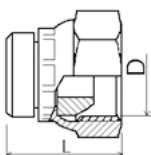

Item Code	Part Number	DN	D inch
2301932	I3B05200-006013	6	1/4
2301933	I3B05200-010017	10	3/8
2301934	I3B05200-013021	13	1/2
2301935	I3B05200-019027	19	3/4
2301936	I3B05200-025034	25	1
2301937	I3B05200-032042	32	1 1/4
2301938	I3B05200-038049	38	1 1/2
2301939	I3B05200-051060	51	2

UNION 3P COUPLING - BUTT WELD END / FEMALE BSP - STAINLESS STEEL 316L

- (FR) RACCORD UNION 3P LISSE - FEMELLE BSP - INOX 316L
- (D) VERSCHRAUBUNG KONISCH DIGHTEND MIT INNENGEWINDE BSPT - EDELSTAHL 1.4404 (AISI 316L)
- (I) RACCORDO UNIONE 3P A SALDARE - FEMMINA BSP - INOX 316L
- (E) CONECTOR 3P LISO - HEMBRA BSP - INOX 316L
- (SV) UNIONSKOPPLING PLAN - SVETSANSLUTNING - INVÄNDIG BSP - SYRAFAST STÅL 316L
- (NO) UNION - SVEIESTUSS - BSP FEMALE SYREFAST 316L
- (DK) UNION 3P KOBLING - GLAT SVEJS - HUNPART BSP - RUSTFRIT STÅL 316L
- (FI) HITSATTAVA LÄHTÖLIITIN BSP SISÄKIERRE HAPONKESTÄVÄ 316L

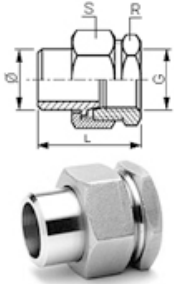

Item Code	Part Number	DN	DN inch	G inch	Ø mm	L mm	R mm	S mm	Weight kg
2300027	I3TQ1307-013017	10	3/8	3/8	17,2	35	21	24	0,060
2302006	I3TQ1307-013021	13	1/2	1/2	21,3	40	27	30	0,105
2300028	I3TQ1307-019027	19	3/4	3/4	26,9	45	36	36	0,170
2300029	I3TQ1307-025034	25	1	1	33,7	50	37	46	0,285
2300030	I3TQ1307-032042	32	1 1/4	1 1/4	42,4	53	46	55	0,375
2300031	I3TQ1307-038049	38	1 1/2	1 1/2	48,3	53	52	60	0,425
2302008	I3TQ1307-051060	51	2	2	60,3	61	63	70	0,585
2302163	I3TQ1307-063076	63	2 1/2	2 1/2	76,1	71	80	92	1,020

UNION 3P COUPLING - BUTT WELD END / MALE BSPT - STAINLESS STEEL 316L

- (FR) RACCORD UNION 3P LISSE - MALE BSPT - INOX 316L
- (D) VERSCHRAUBUNG KONISCH DIGHTEND MIT AUSSENGEWINDE BSPT - EDELSTAHL 1.4404 (AISI 316L)
- (I) RACCORDO UNIONE 3P A SALDARE - MASCHIO BSPT - INOX 316L
- (E) CONECTOR 3P LISO - MACHO BSPT - INOX 316L
- (SV) UNIONSKOPPLING PLAN - SVETSANSLUTNING - UTVÄNDIG BSPT - SYRAFAST STÅL 316L
- (NO) UNION - SVEIESTUSS - BSPT MALE SYREFAST 316L
- (DK) UNION 3P KOBLING - GLAT SVEJS - HANPART BSPT - RUSTFRIT STÅL 316L
- (FI) HITSATTAVA LÄHTÖLIITIN BSP ULKOKIERRE HAPONKESTÄVÄ 316L

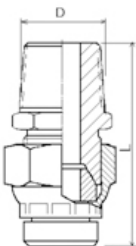

Item Code	Part Number	DN	DN inch	D inch
2300021	I3TQ1207-013017	10	3/8	3/8
2302012	I3TQ1207-013021	13	1/2	1/2
2300022	I3TQ1207-019027	19	3/4	3/4
2300023	I3TQ1207-025034	25	1	1
2300024	I3TQ1207-032042	32	1 1/4	1 1/4
2300025	I3TQ1207-038049	38	1 1/2	1 1/2
2302013	I3TQ1207-051060	51	2	2

Horizontal dotted lines for notes.

Since ALFAGOMMA continually examines ways to improve products, we reserve the right to alter specifications without prior notice.

Weights and dimensions are nominal.

Working pressures for hose are based at ambient temperature of 20 °C (68 °F)

Pictures shown are for illustration purpose only. Actual hose construction might be different.

Refer to local price list for items available in the different sales area.

